

UNITED STATES
SECURITIES AND EXCHANGE COMMISSION
Washington, D.C. 20549

FORM 8-K

CURRENT REPORT
Pursuant to Section 13 or Section 15(d) of the
Securities Exchange Act of 1934

December 5, 2022
Date of Report (Date of earliest event reported)

ROTH CH ACQUISITION IV CO.
(Exact Name of Registrant as Specified in Charter)

Delaware
(State or Other Jurisdiction of
Incorporation)

001-40710
(Commission File Number)

83-3583873
(I.R.S. Employer
Identification Number)

888 San Clemente Drive, Suite 400
Newport Beach, CA
(Address of Principal Executive Offices)

92660
(Zip Code)

Registrant's telephone number, including area code: **(949) 720-5700**

Not Applicable
(Former name or former address, if changed since last report)

Check the appropriate box below if the Form 8-K filing is intended to simultaneously satisfy the filing obligation of the registrant under any of the following provisions:

- Written communications pursuant to Rule 425 under the Securities Act (17 CFR 230.425)
- Soliciting material pursuant to Rule 14a-12 under the Exchange Act (17 CFR 240.14a-12)
- Pre-commencement communications pursuant to Rule 14d-2(b) under the Exchange Act (17 CFR 240.14d-2(b))
- Pre-commencement communications pursuant to Rule 13e-4(c) under the Exchange Act (17 CFR 240.13e-4(c))

Securities registered pursuant to Section 12(b) of the Act:

Title of each class	Trading Symbol(s)	Name of each exchange on which registered
Common Stock	ROCG	The Nasdaq Stock Market LLC
Warrants	ROCGW	The Nasdaq Stock Market LLC
Units	ROCGU	The Nasdaq Stock Market LLC

Indicate by check mark whether the registrant is an emerging growth company as defined in Rule 405 of the Securities Act of 1933 (17 CFR §230.405) or Rule 12b-2 of the Securities Exchange Act of 1934 (17 CFR §240.12b-2).

Emerging growth company

If an emerging growth company, indicate by check mark if the registrant has elected not to use the extended transition period for complying with any new or revised financial accounting standards provided pursuant to Section 13(a) of the Exchange Act.

Item 1.01 Entry into a Material Definitive Agreement.

General

On December 5, 2022, Roth CH Acquisition IV Co., a Delaware corporation (“*Acquiror*”), entered into an Agreement and Plan of Merger (as it may be amended, supplemented or otherwise modified from time to time, the “*Merger Agreement*”), by and among Acquiror, Roth IV Merger Sub Inc., a Delaware corporation and a wholly-owned subsidiary of Acquiror (“*Merger Sub*”), and Tigo Energy, Inc., a Delaware corporation (the “*Company*”). The transactions set forth in the Merger Agreement, including the Merger (defined below), will constitute a “Business Combination” as contemplated by Acquiror’s Amended and Restated Certificate of Incorporation. Unless expressly stated otherwise herein, capitalized terms used but not defined herein shall have such meanings ascribed to them in the Merger Agreement.

Merger Agreement

Subject to the terms and conditions set forth in the Merger Agreement, Merger Sub will merge with and into the Company, with the Company surviving as a wholly-owned subsidiary of Acquiror (the “*Merger*”). Upon the Closing and the other transactions contemplated by the Merger Agreement, the Company will change its name to “Tigo Energy MergeCo, Inc.” and Acquiror will change its name to “Tigo Energy, Inc.”

Consideration

Subject to the terms and conditions set forth in the Merger Agreement, in consideration of the Merger, the Base Purchase Price of \$600,000,000 will be payable through converting each outstanding share of Company Common Stock (after giving effect to the consummation of the Company Warrant Exercise and the Company Preferred Conversion) into the right to receive 60,000,000 shares of Acquiror Common Stock at a deemed price of ten dollars (\$10.00) per share, equal to (a) the Exchange Ratio, multiplied by (b) the number of shares of the Company Common Stock held by such holder as of immediately prior to the effective time of the Merger, with fractional shares rounded down to the nearest whole share. In addition, at the Closing, each outstanding Company Option will be assumed and converted into an option with respect to a number of shares of Acquiror Common Stock in the manner set forth in the Merger Agreement, and each outstanding Company Warrant (after giving effect to the Company Warrant Exercise) to purchase the Company Common Stock will be assumed and converted into a warrant with respect to a number of shares of Acquiror Common Stock in the manner set forth in the Merger Agreement.

The Base Purchase Price is subject to a dollar-for-dollar upward or downward adjustment in the event the Company raises or obtains a commitment to raise capital prior to the Closing, including capital raised through the conversion of debt securities (but specifically excluding capital raised through convertible notes or similar debt instruments convertible into or exercisable for capital stock or other equity securities of the Company to the extent such notes or similar debt instruments have not so converted). If the Company raises or obtains a commitment to raise capital based on a pre-money valuation at or exceeding \$500,000,000, the Base Purchase Price will increase by the aggregate amount of capital raised or committed to be raised by the Company through such capital raising transaction. Conversely, if the pre-money valuation is below \$500,000,000, the Base Purchase Price will decrease by an amount equal to the difference between \$500,000,000 and the actual pre-money valuation.

Representations and Warranties

The Merger Agreement contains customary representations and warranties of the parties thereto with respect to the parties, the transactions contemplated by the Merger Agreement and their respective business operations and activities. The representations and warranties of the parties do not survive the Closing.

Covenants

The Merger Agreement contains customary covenants of the parties thereto, including: (a) the requirement to make appropriate filings and obtain clearance pursuant to the HSR Act, (b) preparation and filing of a Form S-4 with respect to the shares of Acquiror Common Stock issuable under the Merger Agreement, which Form S-4 will contain the Proxy Statement and the Prospectus for Acquiror Stockholders, and (c) the preparation and delivery of updated audited financial statements for the Company.

The Merger Agreement also contains mutual exclusivity provisions prohibiting (a) the Company and its representatives and subsidiaries from initiating, soliciting, or otherwise encouraging an Acquisition Proposal (subject to certain limited exceptions specified therein), or entering into any contracts or agreements in connection therewith and (b) Acquiror and its subsidiaries from initiating, soliciting, or otherwise encouraging any merger, capital stock exchange, asset acquisition, stock purchase, reorganization, recapitalization or similar business combination (subject to limited exceptions specified therein) or entering into any contracts or agreements in connection therewith.

Promptly after the date of the Merger Agreement, Acquiror will take all necessary action to extend the time period for Acquiror to consummate the Merger (the "*Extension*"). In connection with the Extension, the Company has agreed to advance up to \$500,000 to Sponsors to be used by the Sponsors to pay reasonable and documented out-of-pocket fees and expenses incurred or committed to be incurred in connection with the Extension. Sponsors will repay such advances as contemplated under the Note Agreement. Acquiror has filed a preliminary proxy statement related to a special meeting and stockholder vote regarding the Extension on November 16, 2022.

Conditions to Consummation of the Transactions

Consummation of the transactions contemplated by the Merger Agreement is subject to conditions of the respective parties that are customary for a transaction of this type, including, among others: (a) obtaining the Acquiror Stockholder Approval; (b) obtaining the Company Stockholder Approval; (c) there being no laws or injunctions by governmental authorities or other legal restraint prohibiting consummation of the transactions contemplated under the Merger Agreement; (d) the waiting period applicable to the Merger under the HSR Act having expired (or early termination having been granted); (e) Acquiror having at least \$5,000,001 in net tangible assets, and (f) the Business Combination Marketing Agreement having been terminated and the parties thereto having waived any entitlement to any fees thereunder, other than those payable under the Letter Agreement (as defined below).

Acquiror has separate conditions to closing, including, among others, that (a) no material adverse effect having occurred with respect to the Company, (b) the Company having delivered the Sponsor Consideration to the Sponsors pursuant to the Sale and Purchase Agreement, and (c) the Business Combination Marketing Agreement dated August 5, 2021 by and among Acquiror, Roth Capital Partners, LLC ("*Roth*"), and Craig-Hallum Capital Group LLC ("*Craig-Hallum*") is terminated. The Company has separate conditions to closing, including, among others, that no material adverse effect has occurred with respect to Acquiror.

Termination

The Merger Agreement may be terminated under certain customary and limited circumstances prior to the Closing of the Merger, including: (a) by mutual written consent of Acquiror and the Company; (b) by either party if there is a final non-appealable order issued by a governmental authority preventing or making illegal the consummation of the transactions contemplated by the Merger Agreement; (c) by the Company if Acquiror fails to obtain the Acquiror Stockholder Approval at the special meeting; (d) by Acquiror if the Company fails to obtain of the Company Stockholder Approval within ten (10) business days following the date in which the SEC declares the Form S-4 effective; (e) by either party if the other party's representations or warranties are not true and correct or if the other party breached any of its covenants set forth in the Merger Agreement such that the conditions to Closing would not be satisfied and such breach cannot or has not been cured within the earlier of thirty (30) days' notice by the other party or Closing; (f) by the Company if as of February 28, 2023, if the aggregate amount of (i) cash in the trust account subject to legal, valid, and binding non-redemption agreements by the holders of the Acquiror Common Stock (including cash in the trust account subject to legal, valid, and binding forward purchase agreements with an investor for non-redemption of the Acquiror Common Stock) and (ii) capital actually received by the Company or subject to legal, valid, and binding commitments to fund or close on or prior to the Closing is less than \$15,000,000; and (g) by either party if the Closing has not occurred on or before June 30, 2023.

If the Merger Agreement is terminated by the Company due to the aggregate amount of (i) cash in the trust account subject to legal, valid, and binding non-redemption agreements by the holders of the Acquiror Common Stock (including cash in the trust account subject to legal, valid, and binding forward purchase agreements with an investor for non-redemption of the Acquiror Common Stock) and (ii) capital actually received by the Company or subject to legal, valid, and binding commitments to fund or close on or prior to the Closing being less than \$15,000,000 as of February 28, 2023, then the Company will be required to pay a breakup fee to the Sponsors of \$3,000,000. Otherwise, if the Merger Agreement is validly terminated, none of the parties will have any liability or any further obligation under the Merger Agreement with certain limited exceptions, including liability arising out of fraud or the willful and material breach of the Merger Agreement.

A copy of the Merger Agreement is filed with this Current Report on Form 8-K as Exhibit 2.1 and is incorporated herein by reference. The foregoing description of the Merger Agreement and the transactions contemplated thereby is not complete and is qualified in its entirety by reference to the Merger Agreement filed herewith. The Merger Agreement has been included to provide investors with information regarding its terms. It is not intended to provide any other factual information about Acquiror, the Company or their respective subsidiaries or affiliates. The representations, warranties and covenants contained in the Merger Agreement were made only for purposes of the Merger Agreement and as of specific dates, were solely for the benefit of the parties to the Merger Agreement, may be subject to limitations agreed upon by the contracting parties, including being qualified by confidential disclosures made for the purposes of allocating contractual risk between the parties to the Merger Agreement instead of establishing these matters as facts, and may be subject to standards of materiality applicable to the contracting parties that differ from those applicable to investors. Investors are not third-party beneficiaries under the Merger Agreement and should not rely on the representations, warranties and covenants or any descriptions thereof as characterizations of the actual state of facts or condition of the parties thereto or any of their respective subsidiaries or affiliates. Moreover, information concerning the subject matter of representations and warranties may change after the date hereof, which subsequent information may or may not be fully reflected in Acquiror's public disclosures.

Warrant Consents

Within five (5) business days following the announcement of the Merger Agreement, the holders of the Company Warrants will deliver their consents to exercise their Company Warrants prior to the Closing in accordance with the terms of the Company Warrants. At the effective time of the Merger and by virtue of the Merger, each share of Company Stock such holders receive as a result of the Company Warrant Exercise will be cancelled and converted into the right to receive the applicable portion of the aggregate consideration of the Merger in accordance with the Merger Agreement.

Lock-up Agreement

The Merger Agreement contemplates that, at the Closing, certain security holders of the Company ("***Tigo Holders***"), the Sponsors and other holders of Founder Shares will enter into lock-up agreements (each, a "***Lock-up Agreement***") with the Company and Acquiror. Pursuant to the Lock-up Agreements, Tigo Holders will agree, among other things, that their shares received as Merger consideration may not be transferred until the date that is six (6) months following Closing. Pursuant to the Lock-up Agreements, the Sponsors and other holders of founder shares will agree, among other things, that their founder shares acquired prior to Acquiror's initial public offering may not be transferred until the earlier to occur of (a) twelve (12) months following the date of Closing and (b) the date on which the closing price of the Acquiror Common Stock exceeds twenty dollars (\$20.00) per share (as adjusted for stock splits, stock dividends, reorganization and recapitalization) for any twenty (20) trading days within a thirty (30) trading day period following the six (6) month anniversary of the Closing. So long as, at the time of sale, the sales price of the Acquiror Common Stock exceeds ten dollars (\$10.00) per share, the terms of the Lock-Up Agreement will permit each stockholder to transfer up to fifteen percent (15%) of the shares of Acquiror Common Stock owned by such party outside of the forgoing restrictions; *provided, however*, in the event such stockholder is a member of the board of directors of Acquiror or holds a management position in Acquiror, such stockholder may not transfer any Acquiror Common Stock pursuant to foregoing exception for a period of ninety (90) days after the date of Closing.

A copy of the form of Lock-up Agreement is filed with this Current Report on Form 8-K as Exhibit 10.1 and is incorporated herein by reference. The foregoing description of the form of Lock-up Agreement is not complete and is qualified in its entirety by reference to the form of Lock-up Agreement filed herewith.

Sponsor Support Agreement

Concurrently with the execution of the Merger Agreement, Acquiror entered into the Sponsor Support Agreement with the Sponsor Parties (as defined in the Sponsor Support Agreement), whereby the Sponsor Parties have agreed, among other things, to vote (i) in favor of the adoption of the restated charter and the restated bylaws of Acquiror, (ii) in favor of the adoption and approval of the Merger Agreement, (iii) in favor of the approval of the issuance of Acquiror Common Stock in connection with the Merger, (iv) in favor of the approval of the equity plans described in Section 7.1 of the Merger Agreement, (v) in favor of the election of directors effective as of the Closing as contemplated by Section 7.6 of the Merger Agreement, (vi) in favor of the adoption and approval of any other proposals as the SEC may indicate are necessary in its comments to the registration statement on Form S-4, (vii) against any Business Combination Proposal, (viii) against any business combination, merger, consolidation, combination, sale of substantial assets, reorganization, recapitalization, dissolution, liquidation or winding up of or by Acquiror (other than as permitted under the Merger Agreement), (ix) against any change in the business, management or board of directors of Acquiror (other than as permitted under the Merger Agreement), and (x) against other action that is intended, or would reasonably be expected, to impede, interfere with or delay or postpone the consummation of, or otherwise adversely affect, any of the Transaction Proposals or any other transaction contemplated by the Merger Agreement or any ancillary agreement or result in a breach of any representation, warranty, covenant or other obligation or agreement of Acquiror, Merger Sub or any Sponsor Party under the Merger Agreement or any ancillary agreement, in each case, to which any of the foregoing is a party; and waive (a) any actions against Acquiror, and (b) their redemption protections with respect to Sponsor Parties' covered shares.

Under the Sponsor Support Agreement, Acquiror's expenses in connection with the negotiation, documentation and consummation of the transactions contemplated in the Merger Agreement (including in connection with Acquiror's initial public offering) are capped at \$5,000,000. If such transaction expenses of Acquiror (including as a result of or in connection with its initial public offering, its operations, other prospective or past Business Combinations, or the negotiation, documentation and consummation of the transactions contemplated by the Merger Agreement that are payable at or prior to the Closing but excluding Acquiror Extension Expenses) exceed such cap, the Sponsors will, pursuant to the Sponsor Support Agreement and at the election of Byron Roth, either (1) pay to Acquiror at Closing an amount in cash equal to the excess amount of transaction expenses of Acquiror or (2) forfeit a number of shares of Acquiror Common Stock held by the Sponsors immediately following the Closing equal to the quotient obtained by dividing the such excess amount of transaction expenses of Acquiror by ten dollars (\$10.00).

A copy of the Sponsor Support Agreement is filed with this Current Report on Form 8-K as Exhibit 10.2 and is incorporated herein by reference. The foregoing description of the Sponsor Support Agreement is not complete and is qualified in its entirety by reference to the Sponsor Support Agreement filed herewith.

Company Holders Support Agreement

Within five (5) business days following the announcement of the Merger Agreement, Acquiror and the Requisite Company Stockholders who hold sufficient amount of shares to approve the transaction will enter into the Company Holders Support Agreement pursuant to which they agreed to vote their the Company shares (i) in favor of the Merger and the transactions contemplated by the Merger Agreement (including the conversion of outstanding shares of preferred stock into the Company Common Stock immediately prior to the Closing), (ii) against any Acquisition Proposal, (iii) against any merger agreement, merger, consolidation, combination, sale of substantial assets, reorganization, recapitalization, dissolution, liquidation or winding up of or by the Company (other than the Merger Agreement, a Capital Raising Transaction or the transactions contemplated thereby) (iv) against any change in the business, management or board of directors of the Company (other than as permitted under the Merger Agreement), and (v) against any other action that is intended, or would reasonably be expected, to impede, interfere with or delay or postpone the consummation of, or otherwise adversely affect, any of the Transaction Proposals or any other transaction contemplated by the Merger Agreement or any ancillary agreement or result in a breach of any representation, warranty, covenant or other obligation or agreement of the Company under the Merger Agreement or any ancillary agreement, or result in a breach of any covenant, representation or warranty of the Company Stockholder contained in the Company Holders Support Agreement.

A copy of the Company Holders Support Agreement is filed with this Current Report on Form 8-K as Exhibit 10.3 and is incorporated herein by reference. The foregoing description of the Company Holders Support Agreement is not complete and is qualified in its entirety by reference to the Company Holders Support Agreement filed herewith.

Registration Rights Agreement

The Merger Agreement contemplates that, at the Closing, Acquiror, the Sponsors, and certain the Company stockholders holding more than five percent (5%) of the Aggregate Fully Diluted Company Common Shares will enter into an amended and restated registration rights agreement (the "***A&R Registration Rights Agreement***") pursuant to which, among other things, Acquiror will agree to undertake certain shelf registration obligations in accordance with the Securities Act, and certain subsequent related transactions and obligations, including, among other things, undertaking certain registration obligations, and the preparation and filing of required documents.

A copy of the A&R Registration Rights Agreement is filed with this Current Report on Form 8-K as Exhibit 10.4 and is incorporated herein by reference. The foregoing description of the A&R Registration Rights Agreement is not complete and is qualified in its entirety by reference to the A&R Registration Rights Agreement filed herewith.

Sale and Purchase Agreement

Concurrently with the execution of the Merger Agreement, the Company and the Sponsors entered into the Sale and Purchase Agreement pursuant to which, immediately prior to the effective time of the Merger, the Sponsors will sell to the Company 1,645,000 shares of Acquiror Common Stock and 424,000 Acquiror Private Units in exchange for an amount equal to \$2,300,000 pursuant to the Sale and Purchase Agreement, and such purchased equity will be cancelled on the books and records of Acquiror at the effective time of the Merger.

A copy of the Sale and Purchase Agreement is filed with this Current Report on Form 8-K as Exhibit 10.5 and is incorporated herein by reference. The foregoing description of the Sale and Purchase Agreement is not complete and is qualified in its entirety by reference to the Sale and Purchase Agreement filed herewith.

Note Agreement

Concurrently with the execution of the Merger Agreement, the Company and the Sponsors entered into the Note Agreement pursuant to which the Sponsors are required to repay the full amount of the expenses funded by the Company to extend the period for Acquiror to consummate a Business Combination as contemplated in the Merger Agreement. Pursuant to the Note Agreement, the outstanding principal amount under the Note Agreement becomes immediately due and payable in full, together with all accrued and unpaid interest thereon, on the earlier of (i) on July 6, 2023, (ii) the consummation of the transactions contemplated by the Sale and Purchase Agreement; or (iii) the termination of the Merger Agreement.

A copy of the Note Agreement is filed with this Current Report on Form 8-K as Exhibit 10.6 and is incorporated herein by reference. The foregoing description of the Note Agreement is not complete and is qualified in its entirety by reference to the Note Agreement filed herewith.

Restrictive Covenant Agreements

In connection with the Merger Agreement, at the Closing, certain employees of the Company have agreed to enter into restrictive covenant agreements in the form attached to the Merger Agreement (the "***Restrictive Covenant Agreements***") in good faith, which will contain a non-compete, non-solicit and non-disparagement restrictions with a restrictive period of four (4) years from the date of the Closing. They will also include customary confidentiality provisions, among others.

A copy of the Restrictive Covenant Agreement is filed with this Current Report on Form 8-K as Exhibit 10.7 and is incorporated herein by reference. The foregoing description of the Restrictive Covenant Agreement is not complete and is qualified in its entirety by reference to the Restrictive Covenant Agreement filed herewith.

Employment Agreements

In connection with the Merger Agreement, prior to the Closing, the Company will negotiate employment agreements (including related to severance provisions) in good faith with each of the employees of the Company, which will be contingent upon, and effective as of, the Closing.

Termination of Business Combination Marketing Agreement

Concurrently with the execution of the Merger Agreement, the Company entered into a letter agreement with Acquiror, Roth and Craig-Hallum to terminate that certain Business Combination Marketing Agreement, dated as of August 5, 2021, by and among Acquiror, Roth and Craig-Hallum (the "**Letter Agreement**").

Pursuant to the Letter Agreement, in exchange for services rendered in connection with the transactions contemplated in the Merger Agreement, Roth may be issued up to 300,000 Advisor Shares (as such term is defined in the Letter Agreement), issuable based on (a) the gross proceeds received from a capital raising transaction involving the equity securities of the Company and (b) the amount remaining in Acquiror's trust account after giving effect to any redemptions (as further described in the Letter Agreement).

A copy of the Letter Agreement is filed with this Current Report on Form 8-K as Exhibit 10.8 and is incorporated herein by reference. The foregoing description of the Letter Agreement is not complete and is qualified in its entirety by reference to the Letter Agreement filed herewith.

Item 7.01 Regulation FD Disclosure

On December 6, 2022, Acquiror and the Company issued a joint press release announcing the execution of the Merger Agreement. A copy of the press release is furnished herewith as Exhibit 99.1 and incorporated by reference herein.

Also furnished herewith as Exhibit 99.2 hereto and incorporated into this Item 7.01 by reference is the investor presentation to be used by Acquiror to discuss the Merger and the other transactions contemplated by the Merger Agreement with Acquiror stockholders.

The foregoing (including the information presented in Exhibits 99.1 and 99.2) is being furnished pursuant to Item 7.01 and will not be deemed to be filed for purposes of Section 18 of the Exchange Act, or otherwise be subject to the liabilities of that section, nor will it be deemed to be incorporated by reference in any filing under the Securities Act or the Exchange Act. The submission of the information set forth in this Item 7.01 shall not be deemed an admission as to the materiality of any information in this Item 7.01, including the information presented in Exhibits 99.1 and 99.2 that is provided solely in connection with Regulation FD.

Additional Information and Where to Find It

This document relates to the proposed Merger involving Acquiror and the Company. In connection with the proposed Merger, Acquiror intends to file a registration statement on Form S-4 with the SEC, which will include a document that serves as a prospectus and proxy statement of Acquiror, referred to as a proxy statement/prospectus, and each party will file other documents with the SEC regarding the proposed transaction. A definitive proxy statement/prospectus will also be sent to the stockholders of Acquiror, seeking any required stockholder approvals. **Investors and security holders of Acquiror and the Company are urged to carefully read the entire proxy statement/prospectus, when it becomes available, and any other relevant documents that have been or will be filed with the SEC, as well as any amendments or supplements to these documents, because they will contain important information about the proposed transaction. The documents filed by Acquiror with the SEC may be obtained free of charge at the SEC's website at www.sec.gov. Alternatively, these documents, when available, can be obtained free of charge from Acquiror upon written request to Roth CH Acquisition IV Co., 888 San Clemente Drive, Suite 400, Newport Beach, California 92660.**

INVESTMENT IN ANY SECURITIES DESCRIBED HEREIN HAS NOT BEEN APPROVED OR DISAPPROVED BY THE SEC OR ANY OTHER REGULATORY AUTHORITY NOR HAS ANY AUTHORITY PASSED UPON OR ENDORSED THE MERITS OF THE ACCURACY OR ADEQUACY OF THE INFORMATION CONTAINED THEREIN.

No Offer or Solicitation

This Current Report on Form 8-K shall not constitute a solicitation of a proxy, consent or authorization with respect to any securities or in respect of any business combination. This Current Report on Form 8-K shall also not constitute an offer to sell or the solicitation of an offer to buy or subscribe for any securities or a solicitation of any vote of approval, nor shall there be any sale, issuance or transfer of securities in any states or jurisdictions in which such offer, solicitation or sale would be unlawful prior to registration or qualification under the securities laws of any such jurisdiction. No offering of securities shall be made except by means of a prospectus meeting the requirements of section 10 of the Securities Act.

Participants in the Solicitation

Acquiror, the Company and certain of their respective directors and executive officers may be deemed to be participants in the solicitation of proxies, in favor of the approval of the proposed Merger-related matters. Information regarding Acquiror's directors and executive officers is contained in the section of Acquiror's Form S-1 titled "Management", which went effective with the SEC on August 5, 2021. Additional information regarding the interests of those participants and other persons who may be deemed participants in the transaction may be obtained by reading the Acquiror proxy statement/prospectus and other relevant documents filed with the SEC when they become available.

Forward-Looking Statements

This Current Report on Form 8-K and the attachments hereto contain forward-looking statements for purposes of the safe harbor provisions under the United States Private Securities Litigation Reform Act of 1995, including statements about the parties' ability to close the proposed transactions, the anticipated benefits of the proposed transaction, and the financial condition, results of operations, earnings outlook and prospects of Acquiror and/or the Company, and may include statements for the period following the consummation of the proposed transactions. Forward-looking statements are typically identified by words such as "plan," "believe," "expect," "anticipate," "intend," "outlook," "estimate," "forecast," "project," "continue," "could," "may," "might," "possible," "potential," "predict," "should," "would" and other similar words and expressions, but the absence of these words does not mean that a statement is not forward-looking.

The forward-looking statements are based on the current expectations of the management of Acquiror and the Company, as applicable, and are inherently subject to uncertainties and changes in circumstances and their potential effects and speak only as of the date of such statement. There can be no assurance that future developments will be those that have been anticipated. These forward-looking statements involve a number of risks, uncertainties or other assumptions that may cause actual results or performance to be materially different from those expressed or implied by these forward-looking statements. Certain of these risks are identified and discussed in Acquiror's final prospectus for its initial public offering filed with the SEC on August 6, 2021 under the heading "Risk Factors." These risk factors will be important to consider in determining future results and should be reviewed in their entirety. These risks and uncertainties include, but are not limited to, those discussed and identified in public filings made with the SEC by Acquiror and the following: (i) expectations regarding the Company's strategies and future financial performance, including its future business plans or objectives, prospective performance and opportunities and competitors, revenues, products and services, pricing, operating expenses, market trends, liquidity, cash flows and uses of cash, capital expenditures, and the Company's ability to invest in growth initiatives and pursue acquisition opportunities; (ii) the occurrence of any event, change or other circumstances that could give rise to the termination of the Merger Agreement; (iii) the outcome of any legal proceedings that may be instituted against Acquiror or the Company following announcement of the Merger Agreement and the transactions contemplated therein; (iv) the inability to complete the proposed Merger due to, among other things, the failure to obtain Acquiror stockholder approval on the expected terms and schedule and the risk that regulatory approvals required for the merger are not obtained or are obtained subject to conditions that are not anticipated; (v) the risk that the proposed Merger or other business combination may not be completed by Acquiror's Merger deadline and the potential failure to obtain an extension of the Merger deadline (vi) the risk that the announcement and consummation of the proposed Merger disrupts the Company's current operations and future plans; (vii) the ability to recognize the anticipated benefits of the proposed Merger; (viii) unexpected costs related to the proposed Merger; (ix) the amount of any redemptions by existing holders of the Acquiror Common Stock being greater than expected; (x) limited liquidity and trading of Acquiror's securities; (xi) geopolitical risk and changes in applicable laws or regulations; (xii) the possibility that Acquiror and/or the Company may be adversely affected by other economic, business, and/or competitive factors; (xiii) operational risk; (xiv) risk that the COVID-19 pandemic, and local, state, and federal responses to addressing the pandemic may have an adverse effect on our business operations, as well as our financial condition and results of operations; and (xv) the risks that the consummation of the proposed Merger is substantially delayed or does not occur.

Should one or more of these risks or uncertainties materialize or should any of the assumptions made by the management of Acquiror and the Company prove incorrect, actual results may vary in material respects from those projected in these forward-looking statements. The foregoing list of factors is not intended to be all-inclusive or to contain all the information that a person may desire in considering an investment in Acquiror and is not intended to form the basis of an investment decision in Acquiror. Readers should carefully review the foregoing factors and other risks and uncertainties described in the "Risk Factors" section of the registration statement on Form S-4 and the other reports, which Acquiror has filed or will file from time to time with the SEC. There may be additional risks that neither Acquiror nor the Company presently know, or that Acquiror and the Company currently believe are immaterial, that could cause actual results to differ from those contained in forward looking statements. For these reasons, among others, investors and other interested persons are cautioned not to place undue reliance upon any forward-looking statements in this press release. All subsequent written and oral forward-looking statements concerning Acquiror and the Company, the proposed Merger or other matters and attributable to Acquiror and the Company or any person acting on their behalf are expressly qualified in their entirety by the cautionary statements above.

All subsequent written and oral forward-looking statements concerning the proposed Merger or other matters addressed in this Current Report on Form 8-K and attributable to Acquiror, the Company or any person acting on their behalf are expressly qualified in their entirety by the cautionary statements contained or referred to in this Current Report on Form 8-K. Except to the extent required by applicable law or regulation, Acquiror and the Company undertake no obligation to update these forward-looking statements to reflect events or circumstances after the date of this Current Report on Form 8-K to reflect the occurrence of unanticipated events.

Item 9.01 Financial Statements and Exhibits

(d) Exhibits.

Exhibit Number	Description
2.1†	Merger Agreement, by and among Roth CH Acquisition IV Co., Tigo Energy, Inc. and Roth IV Merger Sub Inc., dated as of December 5, 2022.
10.1	Form of Lock-up Agreement.
10.2†	Sponsor Support Agreement, dated as of December 5, 2022.
10.3	Form of Company Holders Support Agreement.
10.4	Form of A&R Registration Rights Agreement.
10.5†	Sale and Purchase Agreement, dated as of December 5, 2022.
10.6	Note Agreement, dated as of December 5, 2022.
10.7	Form of Restrictive Covenant Agreement.
10.8	Letter Agreement, dated as of December 5, 2022.
99.1	Press Release, dated as of December 6, 2022.
99.2	Investor Presentation, dated as of December 6, 2022.
104	Cover Page Interactive Data File, formatted in Inline Extensible Business Reporting Language (iXBRL)

† Certain of the exhibits and schedules to this Exhibit have been omitted in accordance with Regulation S-K Item 601(b)(2). The Registrant agrees to furnish supplementally a copy of all omitted exhibits and schedules to the Securities and Exchange Commission upon its request.

SIGNATURES

Pursuant to the requirements of the Securities Exchange Act of 1934, the registrant has duly caused this report to be signed on its behalf by the undersigned hereunto duly authorized.

Dated: December 6, 2022

ROTH CH ACQUISITION IV CO.

By: /s/ Byron Roth
Name: Byron Roth
Title: Co-Chief Executive Officer and Chairman of the Board

AGREEMENT AND PLAN OF MERGER

by and among

ROTH CH ACQUISITION IV CO.

ROTH IV MERGER SUB INC.,

and

TIGO ENERGY, INC.

dated as of December 5, 2022

TABLE OF CONTENTS

ARTICLE I

CERTAIN DEFINITIONS

Section 1.1.	Definitions	4
Section 1.2.	Construction	25
Section 1.3.	Knowledge	25

ARTICLE II

THE MERGER; CLOSING

Section 2.1.	The Merger	26
Section 2.2.	Effects of the Merger	26
Section 2.3.	Closing; Effective Time	26
Section 2.4.	Pre-Closing Deliverables	27
Section 2.5.	Closing Deliverables	28
Section 2.6.	Governing Documents	29
Section 2.7.	Directors and Officers	30
Section 2.8.	Intended Tax Treatment	30

ARTICLE III

EFFECTS OF THE MERGER ON THE COMPANY CAPITAL STOCK, COMPANY OPTIONS, COMPANY WARRANTS, MERGER SUB CAPITAL STOCK AND ACQUIROR UNITS

Section 3.1.	Conversion of Securities	30
Section 3.2.	Exchange Procedures	31
Section 3.3.	Treatment of Company Options and Company Warrants	33
Section 3.4.	Withholding	34
Section 3.5.	Dissenting Shares	34
Section 3.6.	Acquiror Units	34
Section 3.7.	Cancellation of the Purchased Equity	35

ARTICLE IV

REPRESENTATIONS AND WARRANTIES OF THE COMPANY

Section 4.1.	Company Organization	35
Section 4.2.	Subsidiaries	35
Section 4.3.	Due Authorization	36

TABLE OF CONTENTS
(continued)

	Page
Section 4.4.	No Conflict 37
Section 4.5.	Governmental Authorities; Consents 37
Section 4.6.	Capitalization of the Company 38
Section 4.7.	Capitalization of Subsidiaries 39
Section 4.8.	Financial Statements 40
Section 4.9.	Undisclosed Liabilities 41
Section 4.10.	Litigation and Proceedings 42
Section 4.11.	Legal Compliance 42
Section 4.12.	Contracts; No Defaults 42
Section 4.13.	Company Benefit Plans 45
Section 4.14.	Labor Relations; Employees 46
Section 4.15.	Taxes 48
Section 4.16.	Brokers' Fees 50
Section 4.17.	Insurance 51
Section 4.18.	Licenses 51
Section 4.19.	Equipment and Other Tangible Property 51
Section 4.20.	Real Property 52
Section 4.21.	Intellectual Property 52
Section 4.22.	Privacy and Cybersecurity 55
Section 4.23.	Environmental Matters 55
Section 4.24.	Absence of Changes 56
Section 4.25.	Related Party Transactions 56
Section 4.26.	Information Supplied 57
Section 4.27.	Exchange Act 57
Section 4.28.	Certain Business Practices 57
Section 4.29.	No Outside Reliance 58
Section 4.30.	No Additional Representation or Warranties 58
 ARTICLE V 	
REPRESENTATIONS AND WARRANTIES OF ACQUIROR AND MERGER SUB	
Section 5.1.	Acquiror and Merger Sub Organization 59
Section 5.2.	Due Authorization 60
Section 5.3.	No Conflict 61
Section 5.4.	Litigation and Proceedings 61
Section 5.5.	SEC Filings 61
Section 5.6.	Internal Controls; Listing; Financial Statements 62
Section 5.7.	Governmental Authorities; Consents 62
Section 5.8.	Trust Account 64
Section 5.9.	Investment Company Act; JOBS Act 64
Section 5.10.	Absence of Changes 64

TABLE OF CONTENTS
(continued)

	Page	
Section 5.11.	No Undisclosed Liabilities	65
Section 5.12.	Capitalization of Acquiror	64
Section 5.13.	Brokers' Fees	66
Section 5.14.	Indebtedness	66
Section 5.15.	Sponsor Support Agreement	67
Section 5.16.	Related Party Transactions	67
Section 5.17.	Taxes	67
Section 5.18.	Business Activities	68
Section 5.19.	Nasdaq Stock Market Quotation	70
Section 5.20.	Registration Statement and Proxy Statement	70
Section 5.21.	No Outside Reliance	71
Section 5.22.	No Additional Representation or Warranties	71
ARTICLE VI		
COVENANTS OF THE COMPANY		
Section 6.1.	Conduct of Business	72
Section 6.2.	Inspection	76
Section 6.3.	Preparation and Delivery of Updated Interim Financial Statements	76
Section 6.4.	Acquiror Extension Expenses	77
Section 6.5.	Termination of Certain Agreements	77
Section 6.6.	Acquisition Proposals	78
Section 6.7.	Company Employee Matters	78
ARTICLE VII		
COVENANTS OF ACQUIROR		
Section 7.1.	Acquiror Employee Matters	78
Section 7.2.	Trust Account Proceeds and Related Available Equity	79
Section 7.3.	Nasdaq Listing	79
Section 7.4.	No Solicitation by Acquiror	80
Section 7.5.	Acquiror Conduct of Business	80
Section 7.6.	Post-Closing Directors and Officers of Acquiror	83
Section 7.7.	Indemnification and Insurance	83
Section 7.8.	Acquiror Public Filings	84
Section 7.9.	Stockholder Litigation	84
Section 7.10.	Extension	85

TABLE OF CONTENTS
(continued)

Page

ARTICLE VIII

JOINT COVENANTS

Section 8.1.	HSR Act; Other Filings	86
Section 8.2.	Preparation of Proxy Statement and Registration Statement; Stockholders' Meeting and Approvals	87
Section 8.3.	Support of Transaction	91
Section 8.4.	Tax Matters	91
Section 8.5.	Section 16 Matters	92
Section 8.6.	Cooperation; Consultation	92

ARTICLE IX

CONDITIONS TO OBLIGATIONS

Section 9.1.	Conditions to Obligations of Acquiror, Merger Sub, and the Company	92
Section 9.2.	Conditions to Obligations of Acquiror and Merger Sub	94
Section 9.3.	Conditions to the Obligations of the Company	95
Section 9.4.	Frustration of Conditions	95

ARTICLE X

TERMINATION/EFFECTIVENESS

Section 10.1.	Termination	96
Section 10.2.	Effect of Termination	97

ARTICLE XI

MISCELLANEOUS

Section 11.1.	Trust Account Waiver	98
Section 11.2.	Waiver	98
Section 11.3.	Notices	99
Section 11.4.	Assignment	100
Section 11.5.	Rights of Third Parties	100
Section 11.6.	Expenses	100
Section 11.7.	Headings; Counterparts	100
Section 11.8.	Company and Acquiror Disclosure Letters	101
Section 11.9.	Entire Agreement	101
Section 11.10.	Amendments	101
Section 11.11.	Publicity	101

TABLE OF CONTENTS
(continued)

	Page	
Section 11.12.	Severability	102
Section 11.13.	Jurisdiction; Waiver of Jury Trial	102
Section 11.14.	Enforcement	103
Section 11.15.	Non-Recourse	103
Section 11.16.	Non-Survival of Representations, Warranties and Covenants	104
Section 11.17.	Conflicts and Privilege	104
Exhibits		
Exhibit A	Form of Acquiror Restated Charter	
Exhibit B	Form of Acquiror Restated Bylaws	
Exhibit C	Form of Sale and Purchase Agreement	
Exhibit D	Forms of Warrant Consent	
Exhibit E	Form of Restrictive Covenant Agreement	
Exhibit F	Form of Lock-Up Agreement	
Exhibit G	Form of Registration Rights Agreement	
Schedules		
Schedule 1.1	Sponsors	

AGREEMENT AND PLAN OF MERGER

This Agreement and Plan of Merger (this "Agreement"), dated as of December 5, 2022, is made and entered into by and among Roth CH Acquisition IV Co., a Delaware corporation ("Acquiror"), and Roth IV Merger Sub Inc., a Delaware corporation and a direct, wholly-owned Subsidiary of Acquiror ("Merger Sub"), and Tigo Energy, Inc., a Delaware corporation (the "Company"). Capitalized terms used, but not defined, in the recitals below shall have the meaning assigned to such terms in Section 1.1.

RECITALS

WHEREAS, Acquiror is a blank check company incorporated for the purpose of effecting a merger, share exchange, asset acquisition, stock purchase, reorganization or similar business combination with one or more businesses;

WHEREAS, Merger Sub is a newly formed, direct, wholly-owned Subsidiary of Acquiror incorporated for the purpose of effecting the Merger;

WHEREAS, upon the terms and subject to the conditions of this Agreement, and in accordance with the General Corporation Law of the State of Delaware, as amended (the "DGCL"), (x) Merger Sub will merge with and into the Company, the separate corporate existence of Merger Sub will cease, and the Company will be the surviving corporation and a wholly-owned Subsidiary of Acquiror (the "Merger"), (y) the Company will change its name to Tigo Energy MergeCo, Inc., and (z) Acquiror will concurrently or shortly thereafter change its name to "Tigo Energy, Inc.";

WHEREAS, in connection with the transactions contemplated by this Agreement, Acquiror shall adopt, effective as of the Effective Time, (x) subject to obtaining the Acquiror Stockholder Approval, the Second Amended and Restated Certificate of Incorporation (the "Acquiror Restated Charter") and (y) the Amended and Restated Bylaws (the "Acquiror Restated Bylaws") (in the forms attached as Exhibit A and Exhibit B hereto, respectively, with such changes as may be agreed in writing by Acquiror and the Company);

WHEREAS, effective immediately prior to the Effective Time, the Sponsors will sell to the Company 1,645,000 Founder Shares and 424,000 Acquiror Private Units (collectively, the "Purchased Equity") in exchange for the Sponsor Consideration pursuant to that certain Sale and Purchase Agreement (the "Sale and Purchase Agreement"), dated as of the date hereof, by and among the Sponsors and the Company in the form attached as Exhibit C hereto, with such changes as may be agreed in writing by Sponsors and the Company;

WHEREAS, simultaneously with the execution and delivery of this Agreement, the Company and the Sponsors shall enter into that certain unsecured promissory note (the "Note Agreement") dated as of the date hereof, pursuant to which the Sponsors shall be required to repay Sponsor Advances (defined below) initially funded by the Company in accordance with Section 6.4 in the event of the failure of the consummation of the transactions contemplated hereby (with such changes as may be agreed in writing by Sponsors and the Company);

WHEREAS, simultaneously with the execution and delivery of this Agreement, Acquiror, the Company, Roth Capital Partners, LLC, and Craig-Hallum Capital Group LLC shall enter into that certain letter agreement dated December 5, 2022 by and among (the "BCMA Termination Agreement"), pursuant to which, among other things, the Business Combination Marketing Agreement dated August 5, 2021 by and among Acquiror, Roth Capital Partners, LLC and Craig-Hallum Capital Group LLC shall have been terminated, the parties thereto shall have waived any entitlement to any amounts, fees, and expenses in connection with the Business Combination Marketing Agreement, and Acquiror and the Company jointly and severally shall issue up to 300,000 shares of Acquiror Common Stock in accordance with the terms and conditions set forth therein;

WHEREAS, immediately prior to the Effective Time, each share of Company Preferred Stock that is issued and outstanding as of such time will be converted into a number of shares of Company Common Stock in accordance with the Company's Governing Documents (the "Company Preferred Conversion");

WHEREAS, within five (5) Business Days following the public announcement of the parties' entry into this Agreement, each of the holders of the Company Warrants shall have executed and delivered to Acquiror a Warrant Consent, substantially in the form attached as Exhibit D hereto (the "Warrant Consent");

WHEREAS, immediately prior to the Effective Time, subject to Section 3.3(c), the Company shall use reasonable efforts to effect the exercise of all Company Warrants for Company Capital Stock in accordance with their terms on a cashless exercise basis (the "Company Warrant Exercise");

WHEREAS, at the Closing, certain employees of the Company shall have entered into Restrictive Covenant Agreements with the Company substantially in the form attached as Exhibit E hereto, with such changes as may be agreed in writing by the applicable employee, the Acquiror and the Company in good faith (the "Restrictive Covenant Agreements");

WHEREAS, upon the Effective Time and following the Company Warrant Exercise and the Company Preferred Conversion, all shares of the Company Common Stock, will be converted into the right to receive the Aggregate Closing Date Merger Consideration on the terms set forth in this Agreement;

WHEREAS, each of the parties intends that, for United States federal income tax purposes, the Merger qualifies as a "reorganization" within the meaning of Section 368(a) of the Code, to which each of Acquiror, Merger Sub and the Company are parties under Section 368(b) of the Code and as a transaction that qualifies under Section 351 of the Code, and this Agreement is intended to constitute a "plan of reorganization" for purposes of Sections 354, 361 and 368 of the Code and within the meaning of Treasury Regulations Section 1.368-2(g);

WHEREAS, the Board of Directors of the Company has approved this Agreement and the documents contemplated hereby and the transactions contemplated hereby and thereby, declared it advisable for the Company to enter into this Agreement and the other documents contemplated hereby and recommended the approval of this Agreement by the Company's stockholders;

WHEREAS, within five (5) Business Days following the public announcement of the parties' entry into this Agreement, the Requisite Company Stockholders shall have each executed and delivered to Acquiror a Company Holders Support Agreement pursuant to which the Requisite Company Stockholders have agreed, among other things, to vote (whether pursuant to a duly convened meeting of the stockholders of the Company or pursuant to an action by written consent of the stockholders of the Company) in favor of the adoption and approval, promptly following the time at which the Registration Statement shall have been declared effective and delivered or otherwise made available to stockholders, of this Agreement and the other documents contemplated hereby and the transactions contemplated hereby and thereby;

WHEREAS, the Board of Directors of Acquiror has (i) determined that it is advisable for Acquiror to enter into this Agreement and the documents contemplated hereby, (ii) approved the execution and delivery of this Agreement and the documents contemplated hereby and the transactions contemplated hereby and thereby, and (iii) recommended the adoption and approval of this Agreement and the other documents contemplated hereby and the transactions contemplated hereby and thereby by the Acquiror Voting Stockholders;

WHEREAS, Acquiror, as sole stockholder of Merger Sub, has approved and adopted this Agreement and the documents contemplated hereby and the transactions contemplated hereby and thereby;

WHEREAS, in furtherance of the Merger and in accordance with the terms hereof, Acquiror shall provide an opportunity to its stockholders to have their outstanding shares of Acquiror Common Stock redeemed on the terms and subject to the conditions set forth in this Agreement and Acquiror's Governing Documents in connection with obtaining the Acquiror Stockholder Approval;

WHEREAS, as a condition and inducement to the Company's willingness to enter into this Agreement, simultaneously with the execution and delivery of this Agreement, the Sponsors have executed and delivered to the Company the Sponsor Support Agreement pursuant to which the Sponsors have agreed to, among other things, (i) vote to adopt and approve this Agreement and the other documents contemplated hereby and the transactions contemplated hereby and thereby; (ii) waive certain anti-dilution adjustments; and (iii) either pay cash or forfeit a number of Acquiror Common Stock then held by such Sponsors in respect of any Excess Expense Amount (defined below);

WHEREAS, immediately prior to the Effective Time, the Company shall have purchased the Purchased Equity on the terms and subject to the conditions set forth in this Agreement and the Sale and Purchase Agreement;

WHEREAS, at the Closing, all stockholders of the Company shall have entered into a Lock-Up Agreement (the "Lock-Up Agreement") in the form attached hereto as Exhibit F (with such changes as may be agreed in writing by Acquiror and the Company); and

WHEREAS, at the Closing, Acquiror, each holder of the Founder Shares, and certain stockholders of the Company holding more than five percent (5%) of the Aggregate Fully Diluted Company Common Shares and certain stockholders of Acquiror, shall enter into an Amended and Restated Registration Rights Agreement (the "Registration Rights Agreement") substantially in the form attached hereto as Exhibit G.

NOW, THEREFORE, in consideration of the foregoing and the respective representations, warranties, covenants and agreements set forth in this Agreement and intending to be legally bound hereby, Acquiror, Merger Sub and the Company agree as follows:

ARTICLE I

CERTAIN DEFINITIONS

Section 1.1. Definitions. As used herein, the following terms shall have the following meanings:

"\$" means lawful money of the United States.

"Acquiror" has the meaning specified in the Preamble hereto.

"Acquiror Audited Financial Statements" has the meaning specified in Section 5.6(d).

"Acquiror Board" means the board of directors or such other similar governing body of Acquiror.

"Acquiror Board Recommendation" has the meaning specified in Section 8.2(b).

"Acquiror Closing Statement" has the meaning specified in Section 2.4(a).

"Acquiror Common Stock" means common stock, \$0.0001 par value per share, of Acquiror.

"Acquiror Cure Period" has the meaning specified in Section 10.1(f).

"Acquiror Disclosure Letter" has the meaning specified in the introduction to Article V.

"Acquiror Extension Approval" means the approval of the Extension Proposal in accordance with applicable Law, Nasdaq rules and Acquiror's Governing Documents pursuant to Section 7.10.

"Acquiror Extension Expenses" means the aggregate amount up to a maximum of \$500,000.00 of reasonable and documented out-of-pocket fees and expenses of Acquiror incurred or committed to be incurred pursuant to or in furtherance of Section 7.10, including with respect to the Extension Proposal, the Extension Proxy Statement, the Extension Meeting, as the case may be.

“Acquiror Financial Statements” has the meaning specified in Section 5.6(d).

“Acquiror Fundamental Representations” means the representations and warranties made pursuant to (i) the first and second sentences of Section 5.1 (Acquiror and Merger Sub Organization), (ii) Section 5.2 (Due Authorization), (iii) Section 5.12 (Capitalization of Acquiror), and (iv) Section 5.13 (Brokers’ Fees).

“Acquiror Material Adverse Effect” means any Event that, individually or when aggregated with other Events, (i) has had or would reasonably be expected to have a materially adverse effect on the business, assets, financial condition, results of operations or listing status of Acquiror or (ii) is reasonably likely to prevent or materially delay or materially impede the ability of Acquiror to consummate the transactions contemplated by this Agreement and the other transactions contemplated by the other Ancillary Agreements; *provided, however, that* in no event would any of the following, alone or in combination, be deemed to constitute, or be taken into account in determining whether there has been or will be, a “Acquiror Material Adverse Effect”: (a) any change or proposed change in applicable Laws or GAAP or any interpretation thereof following the date of this Agreement, or any interpretation thereof following the date of this Agreement, (b) any change in interest rates or economic, political, business or financial market conditions generally, (c) the compliance with the terms of this Agreement or the taking of any action required or contemplated by this Agreement or with the prior written consent of the Company (it being understood that this clause (c) shall be disregarded for purposes of the representation and warranty set forth in Section 5.3 and the condition to Closing with respect thereto), (d) any natural disaster (including hurricanes, storms, tornados, flooding, earthquakes, volcanic eruptions or similar occurrences), pandemic (including COVID-19, or any COVID-19 Measures or any change in such COVID-19 Measures or interpretations following the date of this Agreement) or change in climate, (e) any acts of terrorism or war, the outbreak or escalation of hostilities, geopolitical conditions, local, national or international political conditions, (f) the announcement of this Agreement and consummation of the transactions contemplated hereby, including any termination of, reduction in or similar adverse impact (but in each case only to the extent attributable to such announcement or consummation) on relationships, contractual or otherwise, (g) any matter set forth on the Acquiror Disclosure Letter, but only to the extent disclosed on the Acquiror Disclosure Letter and not taking into account any events after the date of this Agreement, or (h) any action taken by, or at the request of, the Company; *provided, further*, that any Event referred to in clauses (a), (b), (d), or (e) above may be taken into account in determining if an Acquiror Material Adverse Effect has occurred to the extent it has a disproportionate and adverse effect on the business, assets, results of operations or financial condition of the Acquiror relative to similarly situated companies in the industry in which the Acquiror conducts its operations, but only to the extent of the incremental disproportionate effect on the Acquiror relative to similarly situated companies in the industry in which the Acquiror conducts its operations.

“Acquiror Private Units” the units issued in a private placement simultaneously with the closing of the Acquiror’s initial public offering consisting of one (1) share of Acquiror Common Stock and one-half (1/2) of one (1) Acquiror Private Warrant.

“Acquiror Private Warrants” means a warrant entitling the holder to purchase one share of Acquiror Common Stock at an exercise price of \$11.50 per share that was included in the Acquiror Private Units.

“Acquiror Public Unit” means the units issued in Acquiror’s initial public offering or the overallotment consisting of one (1) share of Acquiror Common Stock and one-half (1/2) of one (1) Acquiror Public Warrant.

“Acquiror Public Warrants” means a warrant entitling the holder to purchase one share of Acquiror Common Stock at an exercise of \$11.50 per share that was included in the units sold as part of the Acquiror’s initial public offering.

“Acquiror Replacement Option” has the meaning specified in Section 3.3(a).

“Acquiror Replacement Warrant” has the meaning specified in Section 3.3(c).

“Acquiror Restated Bylaws” has the meaning specified in the Recitals hereto.

“Acquiror Restated Charter” has the meaning specified in the Recitals hereto.

“Acquiror SEC Filings” has the meaning specified in Section 5.5.

“Acquiror Securities” means the Acquiror Common Stock, Acquiror Warrants, and Acquiror Private Units.

“Acquiror Share Redemption” means the election of an eligible (as determined in accordance with Acquiror’s Governing Documents) holder of Acquiror Common Stock to redeem all or a portion of the shares of Acquiror Common Stock held by such holder at a per-share price, payable in cash, equal to a pro rata share of the aggregate amount on deposit in the Trust Account (including any interest earned on the funds held in the Trust Account) (as determined in accordance with Acquiror’s Governing Documents) in connection with the Transaction Proposals or in connection with Acquiror seeking an “Extension” in accordance with Acquiror’s Governing Documents.

“Acquiror Stockholder Approval” means the approval, as determined in accordance with the Acquiror’s Governing Documents, the DGCL and the rules of the Nasdaq, as applicable, of (i) the Transaction Proposal identified in clause (A) of Section 8.2(b) by the affirmative vote of the holders of at least a majority of the outstanding shares of Acquiror Common Stock entitled to vote thereon, voting as a single class (ii) those Transaction Proposals identified in clauses (B), (C), (D), (F), (G) and, if necessary, (H), of Section 8.2(b), in each case, by an affirmative vote of holders of at least a majority of the votes cast by holders of shares of Acquiror Common Stock, voting as a single class, whether present in person (or virtually) or represented by proxy and entitled to vote thereon, in each case, at the Acquiror Stockholders’ Meeting, and (iii) the Transaction Proposal identified in clause (E) of Section 8.2(b) by a plurality of the votes cast by holders of shares Acquiror Common Stock present in person (or virtually) or represented by proxy at the Acquiror Stockholders’ Meeting and entitled to vote thereon. The vote at the Acquiror Stockholders’ Meeting on any other matter than those described in the first sentence of this definition, including a vote on any separate or unbundled advisory proposals, shall not affect whether the Acquiror Stockholder Approval shall have been obtained.

“Acquiror Stockholders” means the stockholders of Acquiror as of immediately prior to the Effective Time.

“Acquiror Stockholders’ Meeting” has the meaning specified in Section 8.2(b).

“Acquiror Transaction Expenses” means the out-of-pocket fees and expenses of Acquiror (including as a result of or in connection with its initial public offering, its operations, other prospective or past Business Combinations, or the negotiation, documentation and consummation of the transactions contemplated hereby or by the express terms of this Agreement, in each case that are payable at or prior to the Closing but excluding Acquiror Extension Expenses), including (a) all fees, costs, expenses, brokerage fees, commissions (including deferred underwriting commissions), finders’ fees and disbursements of financial advisors, investment banks, data room administrators, attorneys, accountants and other advisors and service providers of Acquiror, (b) fifty percent (50%) of the filing fees paid to the Antitrust Authorities pursuant to making the HSR Filing under Section 8.1, (c) obtaining approval of the Nasdaq under Section 7.3 and obtaining the Acquiror Stockholder Approval, (d) obligations of Acquiror under any Working Capital Loans, (e) one hundred percent (100%) of the fees, costs, expenses and premiums related to the Acquiror’s insurance policies described in Section 7.7(b), (f) any deferred underwriting commissions and other fees and expenses relating to Acquiror’s initial public offering, and (g) Transfer Taxes constituting Acquiror Transaction Expenses under Section 8.4(a), but excluding any Company Transaction Expenses; *provided, that* the aggregate amount of all Acquiror Transaction Expenses shall be subject to the proviso in Section 2.4(a).

“Acquiror Transaction Expenses Cap” has the meaning specified in Section 2.4(a).

“Acquiror Unaudited Financial Statements” has the meaning specified in Section 5.6(d).

“Acquiror Voting Stockholders” means the stockholders of Acquiror as of the record date for the Acquiror Stockholders’ Meeting.

“Acquiror Units” means the Acquiror Public Units and the Acquiror Private Units.

“Acquiror Warrants” means the Acquiror Public Warrants and the Acquiror Private Warrants.

“Acquisition Proposal” means, (i) with respect to the Company and its Subsidiaries, (other than (x) the transactions contemplated hereby, (y) the acquisition or disposition of inventory, equipment or other tangible personal property in the ordinary course of business or (z) the issuance of any class, series, convertible notes or other Equity Interests of Company pursuant to any Capital Raising Transaction) any (a) other issuance, sale or transfer to or investment by a party other than Acquiror in any newly issued or currently outstanding equity interest in the Company (other than equity awards granted to Company employees, or the issuance of Company equity securities upon exercise of equity awards by employees in the ordinary course of business consistent with past practice or warrants currently outstanding, or the transfer or exercise of any outstanding call option rights, or convertible notes), (b) sale or transfer of all or substantially all of the assets of the Company or its subsidiaries to a party other than Acquiror, (c) merger or business combination between the Company or any of its Subsidiaries, on the one hand, and a party other than the Company or one of its Affiliates, on the other hand, or (d) any public offering of the equity securities of the Company or any of its Subsidiaries, and (ii) with respect to the Acquiror any “initial business combination” (as such term is described in the IPO Prospectus with any third party (other than with the Company or its Affiliates)).

“Action” means any claim, action, suit, audit, litigation, complaint, assessment, investigation, examination, arbitration, mediation, hearing, audit, investigation or any proceeding (including any civil, criminal, administrative, investigative or appellate proceeding), commenced, brought, conducted or heard by or before, any court, arbitrator, mediator or other Governmental Authority.

“Actual Capital Raised Amount” means the aggregate amount of (a) cash in the Trust Account subject to legal, valid and binding non-redemption agreements between Acquiror and any holders of Acquiror Common Stock, pursuant to which such holders of Acquiror Common Stock irrevocably and unconditionally agree not to redeem or exercise any right to redeem any shares of Acquiror Common Stock as part of the Acquiror Share Redemptions or otherwise (including any cash in the Trust Account subject to legal, valid and binding forward purchase agreement(s) with a(n) investor(s) for the non-redemption of Acquiror Common Stock), plus (b) the Capital Raise Amount, solely to the extent such aggregate amount is actually received by the Company or subject to legal, valid and binding commitments by the other party to fund or close on or prior to the Closing.

“Affiliate” means, with respect to any specified Person, any Person that, directly or indirectly, controls, is controlled by, or is under common control with, such specified Person, whether through one or more intermediaries or otherwise. The term “control” (including the terms “controlling,” “controlled by” and “under common control with”) means the possession, directly or indirectly, of the power to direct or cause the direction of the management and policies of a Person, whether through the ownership of voting securities, by Contract or otherwise.

“Aggregate Fully Diluted Company Common Shares” means, without duplication, (a) the aggregate number of (i) shares of Company Common Stock that are issued and outstanding immediately prior to the Effective Time including after giving effect to the Company Preferred Conversion, including, for the avoidance of doubt, any dividend payable thereby, and in connection with any Capital Raising Transaction, plus (ii) shares (on an as-converted basis) of Company Common Stock and Company Preferred Stock issuable upon the exercise of Company Options and the Company Warrants, in each case, that are outstanding immediately prior to the Effective Time and as determined on a cashless exercise basis.

“Aggregate Closing Date Merger Consideration” means a number of Acquiror Common Stock equal to the quotient obtained by *dividing* (i) the Closing Date Purchase Price *by* (ii) \$10.00.

“Agreement” has the meaning specified in the Preamble hereto.

“Agreement End Date” has the meaning specified in Section 10.1(e).

“Ancillary Agreements” has the meaning specified in Section 11.9.

“Antitrust Authorities” means the Antitrust Division of the United States Department of Justice and the United States Federal Trade Commission.

“Antitrust Information or Document Request” means any request or demand for the production, delivery or disclosure of documents or other evidence, or any request or demand for the production of witnesses for interviews or depositions or other oral or written testimony, by any Antitrust Authorities relating to the transactions contemplated hereby or by any third party challenging the transactions contemplated hereby, including any so called “second request” for additional information or documentary material or any civil investigative demand made or issued by any Antitrust Authority or any subpoena, interrogatory or deposition.

“Anti-Corruption Laws” means, as applicable, (i) the U.S. Foreign Corrupt Practices Act of 1977, as amended, (ii) the UK Bribery Act 2010, (iii) anti-bribery legislation promulgated by the European Union and implemented by its member states, (iv) legislation implementing the OECD Convention on Combating Bribery of Foreign Public Officials in International Business Transactions and (v) any other applicable anti-corruption/anti-bribery laws.

“Base Purchase Price” means \$600,000,000.00.

“BCMA Termination Agreement” has the meaning specified in the Recitals.

“Business Combination” has the meaning specified in Section 5, paragraph SIXTH of Acquiror’s Amended and Restated Certificate of Incorporation of the Acquiror dated August 5, 2021 as in effect on the date hereof.

“Business Combination Proposal” means any “initial business combination” (as such term is described in the IPO Prospectus with any third party (other than with the Company or its Affiliates)).

“Business Day” means a day other than a Saturday, Sunday or other day on which commercial banks in New York, New York are authorized or required by Law to close.

“Business Systems” means all software, firmware, middleware, equipment, workstations, routers, hubs, computer hardware (whether general or special purpose), electronic data processors, databases, communications, telecommunications, networks, interfaces, platforms, servers, peripherals and computer systems, including any software and systems provided via the cloud or “as a service,” websites and Internet-related information technology infrastructure, wide area network and other data communications or information technology equipment, owned or leased by, licensed to, or used in the conduct of the business of the Company or any of its Subsidiaries.

“Capital Raise Amount” means the aggregate amount of capital raised or committed to be raised by the Company through any Capital Raising Transaction.

“Capital Raise End Date” has the meaning specified in [Section 10.1\(g\)](#).

“Capital Raising Transaction” means any offer, sale or other issuance of Equity Interests or notes or other debt instruments exercisable for or convertible into Company Capital Stock or other equity interests of the Company (including, without limitation, any shares of capital stock, securities convertible in to or exchangeable for shares of capital stock, or warrants, options or other rights for the purchase or acquisition of such shares, and other ownership or profit interests (including, without limitation, partnership, member or trust interest therein), whether voting or non-voting, and convertible notes or similar convertible or exercisable debt instruments) of the Company and/or any of its Subsidiaries for cash occurring at any time, whether in a single transaction or a series of transaction, during the period commencing on or after the date of this Agreement and ending at or prior to the Closing or an agreement to so offer, sell, or issue; *provided that*, with respect to any such convertible notes or similar convertible or exercisable debt instruments contemplated herein, the aggregate amount of capital raised or deemed to be raised shall increase, decrease, or otherwise adjust the Base Purchase Price in accordance with the definition of “Closing Date Purchase Price” to the extent exercised for or converted into Company Capital Stock or other equity interests in the Company on or prior to the Closing Date.

“CARES Act” means the Coronavirus Aid, Relief, and Economic Security Act (Pub. L. 116-136) and any administrative or other guidance published with respect thereto by any Governmental Authority (including IRS Notices 2020-22 and 2020-65), or any other Law or executive order or executive memorandum (including the Memorandum on Deferring Payroll Tax Obligations in Light of the Ongoing COVID-19 Disaster, dated August 8, 2020) intended to address the consequences of COVID-19 (in each case, including any comparable provisions of state, local or non-U.S. Law and including any related or similar orders or declarations from any Governmental Authority).

“Closing” has the meaning specified in [Section 2.3\(a\)](#).

“Closing Date” has the meaning specified in [Section 2.3\(a\)](#).

“Closing Date Purchase Price” means the Base Purchase Price, which shall be subject to upward or downward adjustment solely as follows:

(a) In the event the Company raises or obtains a commitment to raise capital in any Capital Raising Transaction based on a pre-money valuation at or exceeding the Targeted Pre-Money Valuation, the Base Purchase Price shall be increased by the corresponding Capital Raise Amount on a dollar for dollar basis;

(b) In the event the Company raises or obtains a commitment to raise capital in any Capital Raising Transaction based on a pre-money valuation below the Targeted Pre-Money Valuation, the Base Purchase Price shall be decreased by an amount equal to the difference between the Targeted Pre-Money Valuation and the actual pre-money valuation of such Capital Raising Transaction on a dollar for dollar basis;

For the avoidance of doubt, in the event the Company fails to raise or obtain a commitment to raise capital in any Capital Raising Transaction during the Interim Period, there shall be no adjustments or re-adjustments to the Base Purchase Price or related penalties or deductions of any kind whatsoever and the Closing Date Purchase Price shall otherwise not be subject to any adjustment based on Company Transaction Expenses, net debt or working capital of the Company and its Subsidiaries as of the date of this Agreement.

“Code” means the Internal Revenue Code of 1986, as amended.

“Company Certificates” has the meaning specified in [Section 3.2\(a\)](#).

“Company Closing Statement” has the meaning specified in [Section 2.4\(b\)](#).

“Company” has the meaning specified in the Preamble hereto.

“Company Benefit Plan” has the meaning specified in [Section 4.13\(a\)](#).

“Company Capital Stock” means the shares of the Company Common Stock and the Company Preferred Stock.

“Company Common Stock” means the shares of common stock, par value \$0.0001 per share, of the Company.

“Company Cure Period” has the meaning specified in [Section 10.1\(e\)](#).

“Company Data” means all confidential data, information, and data compilations contained in the IT Systems or any databases of the Company or any of its Subsidiaries, including Personal Data, that are used by, or necessary to the business of, the Company or any of its Subsidiaries.

“Company Disclosure Letter” has the meaning specified in the introduction to [Article IV](#).

“Company Fundamental Representations” means the representations and warranties made pursuant to the first and second sentences of [Section 4.1](#) (*Company Organization*), the first and second sentences of [Section 4.2](#) (*Subsidiaries*), [Section 4.3](#) (*Due Authorization*), [Section 4.6](#) (*Capitalization of the Company*), [Section 4.7](#) (*Capitalization of Subsidiaries*) and [Section 4.16](#) (*Brokers’ Fees*).

“Company Group” has the meaning specified in [Section 11.17\(b\)](#).

“Company Holders Support Agreement” means that certain Support Agreement, dated on a date that is no later than five (5) Business Days following the public announcement of the parties’ entry into this Agreement, by and among each of the Requisite Company Stockholders, Acquiror and the Company, as amended or modified from time to time.

“Company Incentive Plans” means, collectively, the Tigo Energy, Inc. 2008 Stock Plan, the Tigo Energy, Inc. 2018 Stock Plan, and the 2013 Officers and Directors Plan, as amended from time to time, and each, individually, a “Company Incentive Plan”.

“Company Indemnified Parties” has the meaning specified in Section 7.7(a).

“Company Material Adverse Effect” means any Event that (i) has had, or would reasonably be expected to have, individually or in the aggregate, a material adverse effect on the business, assets, results of operations or financial condition of the Company and its Subsidiaries, or (ii) is reasonably likely to prevent or materially delay or materially impede the ability of the Company or its Subsidiaries to consummate the transactions contemplated by this Agreement and the other transactions contemplated by the other Ancillary Agreements; *provided, however, that* in no event would any of the following, alone or in combination, be deemed to constitute, or be taken into account in determining whether there has been or will be, a “Company Material Adverse Effect”: (a) any change or proposed change in applicable Laws or GAAP or any interpretation thereof following the date of this Agreement, (b) any change in interest rates or economic, political, business or financial market conditions generally, (c) the compliance with the terms of this Agreement or the taking of any action required or contemplated by this Agreement or with the prior written consent of Acquiror (it being understood that this clause (c) shall be disregarded for purposes of the representation and warranty set forth in Section 4.4 and the condition to Closing with respect thereto), (d) any natural disaster (including hurricanes, storms, tornados, flooding, earthquakes, volcanic eruptions or similar occurrences), pandemic (including COVID-19, or any COVID-19 Measures or any change in such COVID-19 Measures or interpretations following the date of this Agreement) or change in climate, (e) any acts of terrorism or war, the outbreak or escalation of hostilities, geopolitical conditions, local, national or international political conditions, (f) any failure of the Company or any of its Subsidiaries to meet any projections or forecasts (*provided that* clause (f) shall not prevent a determination that any Event not otherwise excluded from this definition of Company Material Adverse Effect underlying such failure to meet projections or forecasts has resulted in a Company Material Adverse Effect), (g) any Events generally applicable to the industries or markets in which the Company and its Subsidiaries operate (including increases in the cost of products, supplies, materials or other goods purchased from third party suppliers), (h) the announcement of this Agreement and consummation of the transactions contemplated hereby, including any termination of, reduction in or similar adverse impact (but in each case only to the extent attributable to such announcement or consummation) on relationships, contractual or otherwise, with any landlords, customers, suppliers, distributors, partners or employees of the Company and its Subsidiaries (it being understood that this clause (h) shall be disregarded for purposes of the representation and warranty set forth in Section 4.4 and the condition to Closing with respect thereto), (i) any matter set forth on the Company Disclosure Letter, but only to the extent disclosed on the Company Disclosure Letter and not taking into account any events after the date of this Agreement, or (j) any action taken by, or at the request of, Acquiror or Merger Sub; *provided, further,* that any Event referred to in clauses (a), (b), (d), (e) or (g) above may be taken into account in determining if a Company Material Adverse Effect has occurred to the extent it has a disproportionate and adverse effect on the business, assets, results of operations or financial condition of the Company and its Subsidiaries, taken as a whole, relative to similarly situated companies in the industry in which the Company and its Subsidiaries conduct their respective operations, but only to the extent of the incremental disproportionate effect on the Company and its Subsidiaries, taken as a whole, relative to similarly situated companies in the industry in which the Company and its Subsidiaries conduct their respective operations.

“Company Option” means an option to purchase shares of Company Common Stock granted under a Company Incentive Plan.

“Company Patents” means the Patents included in the Company Registered Intellectual Property.

“Company Preferred Conversion” has the meaning specified in the Recitals hereto.

“Company Preferred Stock” has the meaning specified in [Section 4.6\(a\)](#).

“Company Privacy Policies” mean any (a) published internal or external past or present data protection, data usage, privacy and security policies of the Company or any of its Subsidiaries, and (b) written public statements relating to privacy, security, or the Processing of Personal Data.

“Company Registered Intellectual Property” has the meaning specified in [Section 4.21\(a\)](#).

“Company Series ABC Preferred Stock” has the meaning specified in [Section 4.6\(a\)](#).

“Company Series D Preferred Stock” has the meaning specified in [Section 4.6\(a\)](#).

“Company Series E Preferred Stock” has the meaning specified in [Section 4.6\(a\)](#).

“Company Software” has the meaning specified in [Section 4.21\(h\)](#).

“Company Stockholder Approvals” means the approval of this Agreement and the transactions contemplated hereby, including the Merger and the transactions contemplated thereby, by the (i) affirmative vote or written consent of the holders of at least a majority of the voting power of the outstanding Company Capital Stock voting as a single class and on an as-converted basis, (ii) the affirmative vote or written consent of the holders of at least a majority of the voting power of the outstanding Company Series ABC Preferred Stock, voting as a single class and on an as-converted basis and (iii) the affirmative vote or written consent of the holders of at least a majority of the voting power of the outstanding Company Series D Preferred Stock, voting as a separate class, and (iv) the affirmative vote or written consent of the holders of at least a majority of the voting power of the outstanding Company Series E Preferred Stock, voting as a separate single series in each case, pursuant to the terms and subject to the conditions of the Company’s Governing Documents and applicable Law.

“Company Termination Fee” has the meaning specified in [Section 10.2](#).

“Company Transaction Expenses” means the following out-of-pocket fees and expenses of the Company or any of its Subsidiaries (whether or not billed or accrued for) as a result of or in connection with the negotiation, documentation and consummation of the transactions contemplated hereby: (i) all fees, costs, expenses, brokerage fees, commissions, finders’ fees and disbursements of financial advisors, investment banks, data room administrators, attorneys, accountants and other advisors and service providers, (ii) change-in-control payments, transaction bonuses, retention or incentive payments, severance or similar compensatory payments payable by the Company or any of its Subsidiaries to any current or former employee (including any amounts due under any consulting agreement with any such former employee), independent contractor, officer or director of the Company or any of its Subsidiaries as a result of the transactions contemplated hereby (and not tied to any subsequent event or condition, such as a termination of employment occurring after the Closing) and the employer portion of any employment, social security or similar taxes due with respect to such amounts, (iii) fifty percent (50%) of the filing fees paid to the Antitrust Authorities pursuant to the making the HSR Filing under Section 8.1 and one hundred percent (100%) of all filing fees payable to the SEC in connection with the filing of the Registration Statement under Section 8.2, (iv) Transfer Taxes constituting Company Transaction Expenses under Section 8.4(a), and (v) amounts owing or that may become owed, payable or otherwise due, directly or indirectly, by the Company or any of its Subsidiaries to any Affiliate of the Company or any of its Subsidiaries in connection with the consummation of the transactions contemplated hereby.

“Company Warrant Exercise” has the meaning specified in the Recitals hereto.

“Company Warrants” means the warrants of the Company to purchase Company Capital Stock.

“Confidentiality Agreement” has the meaning specified in Section 11.9.

“Constituent Corporations” has the meaning specified in Section 2.1(a).

“Contracts” means any legally binding contracts, agreements, arrangements, subcontracts, leases, license agreements, and purchase orders.

“Copyright License” means any license that requires, as a condition of use, modification and/or distribution of software subject to such license, that such software subject to such license, or other software incorporated into, derived from, or used or distributed with such software subject to such license (i) in the case of software, be made available or distributed in a form other than binary (*e.g.*, source code form), (ii) be licensed for the purpose of preparing derivative works, (iii) be licensed under terms that allow the Company’s or any Subsidiary of the Company’s products or portions thereof or interfaces therefor to be reverse engineered, reverse assembled or disassembled (other than by operation of Law), or (iv) be redistributable at no license fee. Copyright Licenses include the GNU General Public License, the GNU Lesser General Public License, the Mozilla Public License, the Common Development and Distribution License, the Eclipse Public License and all Creative Commons “sharealike” licenses.

“Copyrights” means copyrights and all other corresponding rights with respect to works of authorship, and all copyright registrations thereof and applications therefor and renewals, extensions and reversions thereof.

“COVID-19” means SARS-CoV-2 or COVID-19, and any evolutions or mutations thereof or related or associated epidemics, pandemic or disease outbreaks.

“COVID-19 Measures” means any quarantine, “shelter in place,” “stay at home,” workforce reduction, social distancing, shut down, closure, sequester, safety or similar Law, directive, guidelines or recommendations promulgated by any industry group or any Governmental Authority, including the Centers for Disease Control and Prevention and the World Health Organization, in each case, in connection with or in response to COVID-19, including the CARES Act, the Families First Act and the American Rescue Plan Act of 2021.

“D&O Indemnified Parties” has the meaning specified in Section 7.7(a).

“Data Processor” means a natural or legal Person, public authority, agency or other body that Processes Personal Data on behalf of or at the direction of the Company or any of its Subsidiaries.

“Derivative Rights” means, with respect to any Equity Interests of any Person, any and all options, warrants, rights, convertible or exchangeable securities, “phantom” equity rights, equity appreciation rights, profits interests, equity-based performance units, commitments, Contracts, arrangements or undertakings of any kind to which such Person is a party or is bound obligating such Person to issue, deliver or sell, or cause to be issued, delivered or sold, additional shares of capital stock of or other equity (or phantom equity) interests in, or any security (including debt securities) convertible or exercisable for or exchangeable into any capital stock or other equity interest in, such Person.

“DGCL” has the meaning specified in the Recitals hereto.

“Disclosure Letter” means, as applicable, the Company Disclosure Letter or the Acquiror Disclosure Letter.

“Dissenting Shares” has the meaning specified in Section 3.5.

“DLA” has the meaning specified in Section 11.17(a).

“Domain Names” means internet domain names and numbers and uniform resource locators, including applications and registrations thereof.

“Effective Time” has the meaning specified in Section 2.3(b).

“Environmental Laws” means any and all applicable Laws relating to pollution or protection of the environment (including natural resources) or human health and safety (with respect to exposure to Hazardous Materials), or the use, handling, generation, manufacture, processing, distribution, treatment, storage, transportation, labeling, recycling, remediation, cleanup, emission, disposal or release of, or exposure to, Hazardous Materials.

“Equity Interests” shall mean with respect to any Person, any and all shares, interests, participations, rights in, or other equivalents (however designated and whether voting or non-voting) of, such Person’s capital stock or other equity interests (including partnership or limited liability company interests in a partnership or limited liability company or any other interest or participation right that confers on a Person the right to receive a share of the profits and losses, or distributions of assets, of the issuing Person), and all Derivative Rights with respect to any of the foregoing.

“ERISA” has the meaning specified in [Section 4.13\(a\)](#).

“ERISA Affiliate” means any Affiliate or business, whether or not incorporated, that together with the Company would be deemed to be a “single employer” within the meaning of Section 414(b), (c), (m) or (o) of the Code at any relevant time.

“Event” means any event, state of facts, circumstance, occurrence or effect.

“Excess Expense Amount” has the meaning specified in [Section 2.4\(a\)](#).

“Exchange Act” means the Securities Exchange Act of 1934, as amended.

“Exchange Ratio” means the quotient obtained by *dividing* (a) the number of shares constituting the Aggregate Closing Date Merger Consideration, by (b) the number of Aggregate Fully Diluted Company Common Shares.

“Extension Meeting” has the meaning specified in [Section 7.10](#).

“Extension Proposal” has the meaning specified in [Section 7.10](#).

“Extension Proxy Statement” has the meaning specified in [Section 7.10](#).

“Ex-Im Laws” means all applicable Laws relating to the import, export, re-export, transfer, release, shipment, transmission or any other cross-border, international or foreign provision of goods, technology, software or services, including the U.S. Export Administration Regulations, the customs and import Laws administered by U.S. Customs and Border Protection, and the EU Dual Use Regulation.

“Financial Statements” has the meaning specified in [Section 4.8\(a\)](#).

“Founder Shares” means Acquiror Common Stock held by the Sponsor Group.

“GAAP” means generally accepted accounting principles in the United States as in effect from time to time.

“Governing Documents” means the legal document(s) by which any Person (other than an individual) establishes its legal existence or which govern its internal affairs. For example, the “Governing Documents” of a corporation are its certificate of incorporation and by-laws, the “Governing Documents” of a limited partnership are its limited partnership agreement and certificate of limited partnership, the “Governing Documents” of a limited liability company are its operating agreement and certificate of formation and the “Governing Documents” of an exempted company are its memorandum and articles of association.

“Government Closure” has the meaning specified in [Section 8.1\(a\)](#).

“**Governmental Authority**” means any federal, state, provincial, municipal, local or foreign government, governmental authority, taxing authority, regulatory or administrative agency, governmental commission, department, board, bureau, agency or instrumentality, court or tribunal.

“**Governmental Authorization**” has the meaning specified in [Section 4.5](#).

“**Governmental Order**” means any order, judgment, injunction, decree, writ, stipulation, determination, agreement, or award, in each case, entered by or with any Governmental Authority.

“**Hazardous Material**” means any material, substance, chemical, or waste that is listed, regulated or otherwise defined as “hazardous,” “toxic,” or “radioactive,” or as a “pollutant” or “contaminant” (or words of similar intent or meaning) or otherwise regulated or for which liability or standards of care may be imposed, under applicable Environmental Laws, including but not limited to petroleum, petroleum by-products, asbestos or asbestos-containing material, polychlorinated biphenyls, per- and polyfluoroalkyl substances, urea formaldehyde foam insulation, lead, flammable or explosive substances, or pesticides.

“**HSR Act**” means the Hart-Scott-Rodino Antitrust Improvements Act of 1976, as amended, and the rules and regulations promulgated thereunder.

“**HSR Filing**” has the meaning specified in [Section 8.1\(a\)](#).

“**Incentive Equity Plan**” has the meaning specified in [Section 7.1\(a\)](#).

“**Indebtedness**” means with respect to any Person, without duplication, any obligations, contingent or otherwise, in respect of (a) the principal of and premium (if any) in respect of all indebtedness for borrowed money, including accrued interest and any per diem interest accruals, (b) the principal and interest components of capitalized lease obligations under GAAP, (c) amounts drawn (including any accrued and unpaid interest) on letters of credit, bank guarantees, bankers’ acceptances and other similar instruments (solely to the extent such amounts have actually been drawn), (d) the principal of and premium (if any) in respect of obligations evidenced by bonds, debentures, notes and similar instruments, including accrued interest, (e) the termination value of interest rate protection agreements and currency obligation swaps, hedges or similar arrangements (without duplication of other indebtedness supported or guaranteed thereby), (f) the principal and interest components of all obligations to pay the deferred and unpaid purchase price of property and equipment which have been delivered, including “earn outs” and “seller notes”, (g) any obligations to pay the deferred purchase price for any services, except trade accounts payable in the ordinary course of business, and (h) breakage costs, prepayment or early termination premiums, penalties, or other fees or expenses payable as a result of the consummation of the transactions contemplated hereby in respect of any of the items in the foregoing clauses (a) through (g), and (i) all Indebtedness of another Person referred to in clauses (a) through (h) above guaranteed directly or indirectly, jointly or severally.

“**Information Security Program**” means an information security program that when appropriately implemented and maintained would constitute reasonable security procedures and practices appropriate to the nature of Personal Data.

"Intellectual Property" means any and all intellectual property rights in any jurisdiction, including rights in or to the following: (i) patents, patent applications, invention disclosures, and the related continuations, continuations-in-part, divisionals, reissues, re-examinations, substitutions, and extensions thereof; (ii) registered and unregistered trademarks, logos, service marks, trade dress, trade names, slogans, and any pending applications therefor, and internet domain names, together with the goodwill symbolized by or associated with any of the foregoing; (iii) registered and unregistered copyrights, and any applications for registration of copyright, including such corresponding rights in software and other works of authorship; (iv) rights in software (including both object code and source code); and (v) know-how and other trade secrets and confidential information, including ideas, formulas, compositions and inventions (whether or not patentable or reduced to practice).

"Intended Tax Treatment" has the meaning specified in [Section 2.8](#).

"Interim Period" has the meaning specified in [Section 6.1](#).

"Investment Company Act" means the Investment Company Act of 1940, as amended.

"IPO Prospectus" has the meaning specified in [Section 11.1](#).

"IRS" means Internal Revenue Service.

"IT Systems" mean the hardware, software, firmware, middleware, equipment, electronics, platforms, servers, workstations, routers, hubs, switches, interfaces, data, databases, data communication lines, network and telecommunications equipment, websites and Internet-related information technology infrastructure, wide area network and other data communications or information technology equipment, owned or leased by, licensed to, or used to Process Company Data in the conduct of the business of the Company or any of its Subsidiaries.

"JOBS Act" has the meaning specified in [Section 5.6\(a\)](#).

"Law" means any statute, law, including common law, ordinance, rule, regulation, code, directive, or Governmental Order, in each case, of any Governmental Authority.

"Leased Real Property" means all real property leased, licensed, subleased or otherwise used or occupied by the Company or any of its Subsidiaries.

"Licensed Company Intellectual Property," means any Intellectual Property that is owned by a third Person and is licensed to the Company or its Subsidiaries by such Person (or subject to a permission, co-existence agreement, release, waiver or nonexclusive covenant not to sue or other immunity from suit granted in favor of the Company or its Subsidiaries by such Person) that is or has been used, held for use or practiced by the Company or its Subsidiaries.

“Licenses” has the meaning specified in Section 4.18.

“Lien” means all liens, licenses, mortgages, deeds of trust, pledges, hypothecations, security interests, adverse claim or other liens of any kind whether consensual, statutory or otherwise.

“Listing Application” has the meaning specified in Section 7.3.

“Lock-Up Agreement” has the meaning specified in the Recitals hereto.

“Malicious Code” means any malware, viruses, malicious code, “worms,” “Trojan horses,” “back doors,” or other vulnerabilities, or unauthorized tools or scripts that could reasonably be expected to materially adversely impact the confidentiality, integrity or availability of any IT Systems.

“Merger” has the meaning specified in the Recitals hereto.

“Merger Certificate” has the meaning specified in Section 2.1(a).

“Merger Sub” has the meaning specified in the Preamble hereto.

“Merger Sub Capital Stock” means the shares of the common stock, par value \$0.0001 per share, of Merger Sub.

“Modification in Recommendation” has the meaning specified in Section 8.2(b).

“Multemployer Plan” has the meaning specified in Section 4.13(c).

“Nasdaq” has the meaning specified in Section 5.6(e).

“Note Agreement” has the meaning specified in the Recitals hereto.

“Offer Documents” has the meaning specified in Section 8.2(a)(i).

“Open Source License” means any license meeting the Open Source Definition (as promulgated by the Open Source Initiative) or the Free Software Definition (as promulgated by the Free Software Foundation), or any substantially similar license, including any license approved by the Open Source Initiative or any Creative Commons License. “Open Source Licenses” shall include Copyleft Licenses.

“Open Source Materials” means any software subject to an Open Source License.

“Owned Company Intellectual Property” means any Intellectual Property that is owned by the Company or its Subsidiaries.

“Patents” means any domestic or foreign patents and applications, drafts and disclosures relating thereto (and any patents that issue as a result of such applications, drafts and disclosures) and any reissues, divisions, divisionals, continuations, continuations-in-part, provisionals, renewals, extensions, substitutions, reexaminations or invention registrations related to such patents and applications.

“PCAOB” means the Public Company Accounting Oversight Board and any division or subdivision thereof.

“PCAOB Audited Financial Statements” has the meaning specified in Section 4.8(a).

“Permitted Liens” means (i) mechanic’s, materialmen’s and similar Liens arising in the ordinary course of business with respect to any amounts (A) not yet due and payable or (B) which are being contested in good faith through appropriate proceedings and for which adequate accruals or reserves have been established in accordance with GAAP, (ii) Liens for Taxes (A) not yet delinquent or (B) which are being contested in good faith through appropriate proceedings and for which adequate accruals or reserves have been established in accordance with GAAP, (iii) defects or imperfections of title, easements, encroachments, covenants, rights-of-way, conditions, matters that would be apparent from a physical inspection or current, accurate survey of such real property, restrictions and other similar charges or encumbrances that do not, in the aggregate, materially impair the value or materially interfere with the present use of the Leased Real Property, (iv) with respect to any Leased Real Property (A) the interests and rights of the respective lessors with respect thereto, including any statutory landlord liens and any Lien thereon, (B) any Lien permitted or set forth under a Real Property Lease, and (C) any Liens encumbering the underlying fee title of the real property of which the Leased Real Property is a part, (v) zoning, building, entitlement and other land use and environmental regulations promulgated by any Governmental Authority that do not, in the aggregate, materially interfere with the current use of, or materially impair the value of, the Leased Real Property, (vi) non-exclusive licenses of Intellectual Property entered into in the ordinary course of business, (vii) ordinary course purchase money Liens and Liens securing rental payments under operating or capital lease arrangements for amounts not yet due or payable, (viii) other Liens arising in the ordinary course of business and not incurred in connection with the borrowing of money in connection with workers’ compensation, unemployment insurance or other types of social security, (ix) reversionary rights in favor of landlords under any Real Property Leases with respect to any of the buildings or other improvements owned by the Company or any of its Subsidiaries, and (x) Securities Liens.

“Person” means any individual, firm, corporation, partnership, limited liability company, incorporated or unincorporated association, joint venture, joint stock company, Governmental Authority or instrumentality or other entity of any kind.

“Personal Data” means information relating to or reasonably capable of being associated with an identified or identifiable person, device, or household or “personal data.” “personal information,” “protected health information,” “nonpublic personal information,” or other similar terms as defined by Privacy Requirements.

“Policies” has the meaning specified in Section 4.17.

“Privacy Requirements” means any and all Laws, industry requirements, and Contracts relating to the protection or Processing of Personal Data that are applicable to the Company and its Subsidiaries, including, but not limited to: (a) the CAN-SPAM Act of 2003, 15 U.S.C. § 7701, et seq.; the Telephone Consumer Protection Act (“TCPA”), 47 U.S.C. § 227, et seq.; the Fair Credit Reporting Act, 15 U.S.C. § 1681, et seq.; the Electronic Communications Privacy Act, 18 U.S.C. §§ 2510-22; the Stored Communications Act, 18 U.S.C. §§ 2701-12, et seq.; the California Consumer Privacy Act, Cal. Civ. Code § 1798.100, et seq.; the California Customer Records Act, Cal. Civ. Code §§ 1798.80 to 84; California Online Privacy Protection Act, Cal. Bus. & Prof. Code § 22575, et seq.; the New York Department of Financial Services Cybersecurity Regulation, 23 N.Y.C.R.R. § 500, et seq.; the South Carolina Privacy of Consumer Financial and Health Information Regulation, South Carolina Code § 69-58, et seq.; Massachusetts Gen. Law Ch. 93H, 201 C.M.R. § 17.00, et seq.; Nev. Rev. Stat. 603A, et seq.; Cal. Civ. Code § 1798.82, et seq.; N.Y. Gen. Bus. Law § 899-aa, et seq.; N.Y. Gen. Bus. Law § 899-bb, et seq.; 11 N.Y.C.R.R. § 420, et seq.; 11 N.Y.C.R.R. § 421, et seq.; the Illinois Biometric Information Privacy Act, 740 I.L.C.S. § 14, et seq.; the Privacy and Electronic Communications (2002/58/EC); the General Data Protection Regulation (2016/679)(“GDPR”); the GDPR as transposed into United Kingdom national law by operation of section 3 of the European Union (Withdrawal) Act 2018 and as amended by the Data Protection, Privacy and Electronic Communications (Amendments etc.) (EU Exit) Regulations 2019, together with the Data Protection Act 2018; U.S. state and federal Laws that prohibit unfair or deceptive acts and practices, such as the Federal Trade Commission Act, 15 U.S.C. § 45, et seq.; and all other Laws and binding regulations relating to data protection, information security, cybercrime, Security Incident notification, social security number protection, outbound communications and/or electronic marketing, use of electronic data and privacy matters (including online privacy) in any applicable jurisdictions including, but not limited to, the United Kingdom, Australia, Israel, Vietnam, Italy, and the Philippines; (b) each Contract relating to the Processing of Personal Data applicable to the Company and its Subsidiaries; and (c) each applicable rule, code of conduct, or other requirement of self-regulatory bodies and applicable industry standards, including, to the extent applicable, the Payment Card Industry Data Security Standard (“PCI-DSS”).

“Processing,” “Process,” or “Processed” means any collection, access, acquisition, storage, protection, use, recording, maintenance, operation, dissemination, re-use, disposal, disclosure, re-disclosure, deletion, destruction, sale, transfer, modification, or any other processing (as defined by Privacy Requirements) of Company Data or IT Systems.

“Prospectus” has the meaning specified in [Section 8.2\(a\)\(i\)](#).

“Proxy Statement” has the meaning specified in [Section 8.2\(a\)\(i\)](#).

“Purchased Equity” has the meaning specified in the Recitals hereto.

“Q1 Financial Statements” has the meaning specified in [Section 4.8\(a\)](#).

“Q1'23 Financial Statements” has the meaning specified in [Section 6.3\(a\)](#).

“Q2 Financial Statements” has the meaning specified in [Section 4.8\(a\)](#).

“Q3 Financial Statements” has the meaning specified in [Section 6.3\(a\)](#).

“O4 Financial Statements” has the meaning specified in Section 6.3(a).

“Real Property Leases” has the meaning specified in Section 4.20(a)(ii).

“Registration Rights Agreement” has the meaning specified in the Recitals hereto.

“Registration Statement” means the Registration Statement on Form S-4, or other appropriate form, including any pre-effective or post-effective amendments or supplements thereto, to be filed with the SEC by Acquiror under the Securities Act with respect to the Registration Statement Securities.

“Registration Statement Securities” has the meaning specified in Section 8.2(a)(i).

“Requisite Company Stockholders” means each of the holders of Company Capital Stock set forth on Section 8.2(c) of the Company Disclosure Letter.

“Restrictive Covenant Agreements” has the meaning specified in the Recitals hereto.

“Sanctioned Person” means at any time any person who is (i) listed on any Sanctions-related list of designated or blocked persons, (ii) the government of, a resident in, located in, or organized under the laws of a country or territory that is the subject of comprehensively restricted Sanctions (which includes, as of the date of this Agreement, Cuba, Iran, North Korea, Syria, the Crimea, and so-called Donetsk’s People’s Republic and Luhansk People’s Republic regions of Ukraine) or (iii) fifty percent (50%) or more owned or controlled by any of the foregoing.

“Sanctions” means those applicable, economic and financial sanctions Laws, regulations, embargoes and restrictive measures administered or enforced by (i) the United States (including the U.S. Treasury Department’s Office of Foreign Assets Control), (ii) the European Union and its member states, (iii) the United Nations, (iv) His Majesty’s Treasury or (v) any other similar governmental authority with jurisdiction over the Company or any Company Subsidiary.

“Security Incident” means any material unauthorized Processing of Company Data, any material unauthorized access to the Company’s IT Systems, any incident that requires notification to any Person, Governmental Authority, or any other entity under Privacy Requirements or other similar terms as defined by Privacy Requirements.

“Sale and Purchase Agreement” has the meaning specified in the Recitals hereto.

“Sarbanes-Oxley Act” means the Sarbanes-Oxley Act of 2002.

“SEC” means the United States Securities and Exchange Commission.

“Securities Act” means the Securities Act of 1933, as amended.

“Securities Liens” means Liens arising out of, under or in connection with (a) applicable federal, state and local securities Laws and (b) restrictions on transfer, hypothecation or similar actions contained in any Governing Documents.

“Sponsor Advances” has the meaning specified in Section 6.4.

“Sponsors” means those Persons listed on Schedule 1.1.

“Sponsor Group” has the meaning specified in Section 11.17(a).

“Sponsor Consideration” means an amount equal to \$2,300,000.00 payable by the Company to Sponsors by wire transfer of immediately available funds to an account or accounts designated in writing by the Sponsors, pursuant to the Sale and Purchase Agreement.

“Sponsor Support Agreement” means that certain Support Agreement, dated as of the date hereof, by and among the Sponsors, Acquiror and the Company, as amended or modified from time to time.

“Standards Organizations” has the meaning specified in Section 4.21(f).

“Subsidiary” means, with respect to a Person, a corporation or other entity of which more than fifty percent (50%) of the voting power of the equity securities or equity interests is owned, directly or indirectly, by such Person. For the purpose of this Agreement, Tigo Energy Equipment Trading (Suzhou) Co., Ltd. shall be deemed to be a Subsidiary of the Company Group.

“Surviving Corporation” has the meaning specified in Section 2.1(b).

“Targeted Pre-Money Valuation” means \$500,000,000.

“Tax” and “Taxes” means any and all federal, state, local, foreign or other taxes imposed by any Governmental Authority, including all income, gross receipts, license, payroll, net worth, employment, excise, tariffs, severance, stamp, occupation, premium, windfall profits, environmental, customs duties, capital stock, ad valorem, value added, inventory, franchise, profits, withholding, social security (or similar), unemployment, disability, real property, personal property, sales, use, transfer, registration, governmental charges, duties, levies and other similar charges imposed by a Governmental Authority in the nature of a tax, alternative or add-on minimum, or estimated taxes, and including any interest, penalty, or addition thereto.

“Tax Return” means any return, declaration, report, statement, information statement or other document filed or required to be filed with any Governmental Authority with respect to Taxes, including any claims for refunds of Taxes, any information returns and any schedules, attachments, amendments or supplements of any of the foregoing.

“Terminating Acquiror Breach” has the meaning specified in Section 10.1(f).

“Terminating Company Breach” has the meaning specified in Section 10.1(e).

“Title IV Plan” has the meaning specified in Section 4.13(c).

“Trade Secrets” means confidential and proprietary information, whether oral or written, including ideas, designs, concepts, compositions, compilations of information, formulas, patterns, program, device, methods, methodologies, techniques, procedures, processes and other know-how, whether or not patentable, including all writings, memoranda, copies, reports, papers, surveys, analyses, drawings, letters, computer printouts, computer programs, computer applications, tools, specifications, business methods, business processes, business techniques, business plans, data (including customer data and technical data), graphs, charts, sound recordings and pictorial reproductions.

“Trademarks” means unregistered and registered trademarks and service marks, trademark and service mark applications, common law trademarks and service marks, trade dress and logos, trade names, business names, corporate names, product names and other source or business identifiers and the goodwill associated with any of the foregoing and any renewals and extensions of any of the foregoing.

“Transaction Proposals” has the meaning specified in [Section 8.2\(b\)](#).

“Transfer Agent” has the meaning specified in [Section 3.2\(a\)](#).

“Transfer Taxes” has the meaning specified in [Section 8.4](#).

“Treasury Regulations” means the regulations promulgated under the Code by the United States Department of the Treasury (whether in final, proposed or temporary form), as the same may be amended from time to time.

“Trust Account” has the meaning specified in [Section 11.1](#).

“Trust Agreement” has the meaning specified in [Section 5.8\(a\)](#).

“Trustee” has the meaning specified in [Section 5.8\(a\)](#).

“Underwriters” means, collectively, Roth Capital Partners, LLC and Craig-Hallum Capital Group LLC.

“Unpaid Transaction Expenses” has the meaning specified in [Section 2.5\(c\)](#).

“Updated Interim Financial Statements” has the meaning specified in [Section 6.3\(a\)](#).

“W&C” has the meaning specified in [Section 11.17\(b\)](#).

“Warrant Agreement” means the Warrant Agreement, dated as of August 5, 2021, between Acquiror and Continental Stock Transfer & Trust Company.

“Warrant Consent” has the meaning specified in the Recitals.

“Working Capital Loans” means any loan made by any of the Sponsors, an Affiliate of the Sponsors, or any of Acquiror’s officers or directors to Acquiror in order to finance transaction costs in connection with a Business Combination and/or ordinary course working capital needs of Acquiror that occur after the date of this Agreement.

“Written Consent” has the meaning specified in [Section 8.2\(c\)](#).

Section 1.2. Construction

(a) Unless the context of this Agreement otherwise requires, (i) words of any gender include each other gender; (ii) words using the singular or plural number also include the plural or singular number, respectively; (iii) the terms “hereof,” “herein,” “hereby,” “hereto” and derivative or similar words refer to this entire Agreement; (iv) the terms “Article,” “Section” or “Exhibit” refer to the specified Article, Section or Exhibit of this Agreement; (v) the word “including” shall mean “including, without limitation”; and (vi) the word “or” shall be disjunctive but not exclusive.

(b) Unless the context of this Agreement otherwise requires, references to statutes shall include all regulations promulgated thereunder and references to statutes or regulations shall be construed as including all statutory and regulatory provisions consolidating, amending or replacing the statute or regulation.

(c) Whenever this Agreement refers to a number of days, such number shall refer to calendar days unless Business Days are specified.

(d) All accounting terms used herein and not expressly defined herein shall have the meanings given to them under GAAP.

(e) The term “actual fraud” means, with respect to a party to this Agreement, an actual and intentional fraud with respect to the making of the representations and warranties pursuant to (i) [Article IV](#) or [Article V](#) (as applicable), *provided, that* such actual and intentional fraud of such Person shall only be deemed to exist if any of the individuals included on [Section 1.3](#) of the Company Disclosure Letter (in the case of the Company) or [Section 1.3](#) of the Acquiror Disclosure Letter (in the case of Acquiror) had actual knowledge (as opposed to imputed or constructive knowledge) that the representations and warranties made by such Person pursuant to, in the case of the Company, [Article IV](#) as qualified by the Company Disclosure Letter, or, in the case of Acquiror, [Article V](#) as qualified by the Acquiror Disclosure Letter, or (ii) any certificate required to be delivered on behalf of thereof prior to or at the Closing pursuant to the terms of this Agreement, were actually breached when made, with the express intention that the other party to this Agreement rely thereon to its detriment. The term “actual fraud” shall not include any fraud claims based on constructive knowledge, negligent misrepresentation, recklessness or any similar theory.

Section 1.3. Knowledge. As used herein, (i) the phrase “to the knowledge” of the Company shall mean the actual knowledge (as opposed to imputed or constructive knowledge) of the individuals identified on [Section 1.3](#) of the Company Disclosure Letter and (ii) the phrase “to the knowledge” of Acquiror shall mean the actual knowledge (as opposed to imputed or constructive knowledge) of the individuals identified on [Section 1.3](#) of the Acquiror Disclosure Letter, in each case with respect to both clauses (i) and (ii), as such respective individuals would have acquired in the exercise of a reasonable inquiry of direct reports.

ARTICLE II

THE MERGER; CLOSING

Section 2.1. The Merger.

(a) Upon the terms and subject to the conditions set forth in this Agreement, Acquiror, Merger Sub and the Company (Merger Sub and the Company sometimes being referred to herein as the “Constituent Corporations”) shall cause Merger Sub to be merged with and into the Company, with the Company being the surviving corporation in the Merger. The Merger shall be consummated in accordance with this Agreement and shall be evidenced by a certificate of merger with respect to the Merger (as so filed, the “Merger Certificate”), executed by the Constituent Corporations in accordance with the relevant provisions of the DGCL, such Merger to be effective as of the Effective Time.

(b) Upon consummation of the Merger, the separate corporate existence of Merger Sub shall cease and the Company, as the surviving corporation of the Merger (hereinafter referred to for the periods at and after the Effective Time as the “Surviving Corporation”), shall continue its corporate existence under the DGCL, as a wholly-owned Subsidiary of Acquiror.

Section 2.2. Effects of the Merger. At and after the Effective Time, the Surviving Corporation shall thereupon and thereafter assume and possess all of the rights, privileges, powers and franchises, of a public as well as a private nature, of the Constituent Corporations, and shall assume and become subject to all the restrictions, disabilities, obligations and duties of each of the Constituent Corporations; and all rights, privileges, powers and franchises of each Constituent Corporation, and all property, real, personal and mixed, and all debts due to each such Constituent Corporation, on whatever account, shall become vested in the Surviving Corporation; and all property, rights, privileges, powers and franchises, and all and every other interest shall become thereafter the property of the Surviving Corporation as they are of the Constituent Corporations; all of the foregoing in accordance with the applicable provisions of the DGCL.

Section 2.3. Closing; Effective Time.

(a) In accordance with the terms and subject to the conditions of this Agreement, the occurrence of the Merger at the Effective Time and the closing of the rest of the transactions contemplated hereby that are to occur on the same date as the Effective Time (the “Closing”) shall take place remotely by the mutual exchange of electronic signatures by the means provided in Section 11.3 at 10:00 a.m. (New York time) on the date which is two (2) Business Days after the first date on which all conditions set forth in Article IX shall have been satisfied or waived (other than those conditions that by their terms are to be satisfied at the Closing, but subject to the satisfaction or waiver thereof) or such other time and place as Acquiror and the Company may mutually agree in writing. The date on which the Closing actually occurs is referred to in this Agreement as the “Closing Date”.

(b) Subject to the satisfaction or waiver of all of the conditions set forth in Article IX of this Agreement, and provided this Agreement has not theretofore been terminated pursuant to its terms, Acquiror, Merger Sub, and the Company shall cause the Merger Certificate to be executed and duly submitted for filing with the Secretary of State of the State of Delaware in accordance with the applicable provisions of the DGCL. The Merger shall become effective at the time when the Merger Certificate has been accepted for filing by the Secretary of State of the State of Delaware, or at such later time as may be agreed by Acquiror and the Company in writing and specified in each of the Merger Certificate (the “Effective Time”).

(a) Not less than two (2) Business Days prior to the Closing Date, Acquiror shall prepare and deliver to the Company a statement setting forth Acquiror's good faith determination of the (i) aggregate amount paid or payable in connection with all Acquiror Share Redemptions (and total cash proceeds from the Trust Account remaining following the Acquiror Share Redemptions), (ii) Acquiror Transaction Expenses and the Acquiror Extension Expenses as of the Closing Date (in each case, in reasonable detail and with reasonable supporting documentation to enable a review of such statement by the Company), including the respective amounts and wire transfer instructions for the payment of all Acquiror Transaction Expenses and Acquiror Extension Expenses, together with corresponding invoices therefor and applicable tax forms of the relevant payees (e.g., IRS Form W-9 or W-8) (the "Acquiror Closing Statement"); *provided, that*, notwithstanding anything to the contrary in this Agreement, if the aggregate amount of Acquiror Transaction Expenses exceeds \$5,000,000 (the "Acquiror Transaction Expenses Cap") and such excess, the "Excess Expense Amount"), the Sponsors shall, pursuant to the Sponsor Support Agreement and at the election of Sponsors, either (1) pay to Acquiror at Closing an amount in cash equal to the Excess Expense Amount or (2) forfeit a number of shares of Acquiror Common Stock held by Sponsors immediately following the Closing equal to the quotient obtained by dividing the Excess Expense Amount by \$10.00.

(b) Not less than two (2) Business Days prior to the Closing Date, the Company shall prepare and deliver to Acquiror:

(i) a statement setting forth the Company's good faith determination of Company Transaction Expenses as of the Closing Date (in reasonable detail and with reasonable supporting documentation to enable a review of such statement by Acquiror), including the respective amounts and wire transfer instructions for the payment thereof, together with corresponding invoices therefor (the "Company Closing Statement"); and

(ii) a certificate signed by an officer of the Company, dated as of the date of such certification (which shall be no more than five (5) Business Days before the Closing Date), certifying that to the knowledge and belief of such officer, attached thereto in writing is (A) a statement setting forth the Company's calculations of (1) the Aggregate Fully Diluted Company Common Shares (including the calculation of each component thereof together with reasonable supporting detail and documentation), (2) the Closing Date Purchase Price (including the calculation of each component thereof together with reasonable supporting detail and documentation), (3) the Aggregate Closing Date Merger Consideration (including the calculation of each component thereof together with reasonable supporting detail and documentation), (4) the Exchange Ratio (including the calculation of each component thereof together with reasonable supporting detail and documentation), (5) the number of Acquiror Common Stock that each applicable holder is entitled to receive pursuant to Section 3.1(a), (c) and (d) (including the calculation of each component thereof together with reasonable supporting detail and documentation), (B) a good faith estimate by the Company of the consolidated balance sheet of the Company and its Subsidiaries as of immediately prior to the Effective Time and (C) that all such calculations and amounts have been prepared in good faith using the latest available financial information of the Company and its Subsidiaries (collectively, the "Closing Certificate"). Acquiror shall be entitled to review and make reasonable comments on the calculations and amounts set forth in the Closing Certificate so delivered by the Company pursuant to this Section 2.4(b)(ii). The Company will cooperate with Acquiror in the review of the Closing Certificate, including providing Acquiror and its representatives with reasonable access to the relevant books, records and finance employees of the Company. The Company will cooperate reasonably with Acquiror to revise the Closing Certificate if necessary to reflect Acquiror's reasonable comments. If the Closing Certificate is so revised, such revised Closing Certificate, or if Acquiror had no such comments, then the initial Closing Certificate shall be deemed to be the final "Closing Statement," in each case as approved in writing by Acquiror (which approval shall not be unreasonably withheld, conditioned or delayed).

Section 2.5. Closing Deliverables.

(a) At the Closing, the Company will deliver or cause to be delivered:

(i) to Acquiror, a certificate signed by an officer of the Company, dated as of the Closing Date, certifying that, to the knowledge and belief of such officer, the conditions specified in Section 9.2(a) and Section 9.2(b) have been fulfilled;

(ii) to Acquiror, the written resignations of all of the directors of the Company (other than any such Persons identified as initial directors of the Surviving Corporation, in accordance with Section 2.7), effective as of the Effective Time;

(iii) to Acquiror, the Registration Rights Agreement, duly executed by those certain stockholders of the Company holding more than five percent (5%) of the Aggregate Fully Diluted Company Common Shares;

(iv) to Acquiror, a certificate signed by an officer of the Company, prepared in a manner consistent and in accordance with the requirements of Treasury Regulations Sections 1.897-2(g), (h) and 1.1445-2(c)(3), certifying that no interest in the Company is, or has been during the relevant period specified in Section 897(c)(1)(A)(ii) of the Code, a "U.S. real property interest" within the meaning of Section 897(c) of the Code, and a form of notice to the IRS prepared in accordance with the provisions of Treasury Regulations Section 1.897-2(h)(2); and

(v) to Sponsors, the Sponsor Consideration.

(b) At the Closing, Acquiror will deliver or cause to be delivered:

(i) to the Transfer Agent, for further distribution to the record holders of shares of Company Capital Stock, Company Options, and Company Warrants entitled to receive a portion of the Aggregate Closing Date Merger Consideration (other than Dissenting Shares), the Aggregate Closing Date Merger Consideration in book-entry form;

(ii) to the Company, a certificate signed by an officer of Acquiror, dated the Closing Date, certifying that, to the knowledge and belief of such officer, the conditions specified in Section 9.3(a) and Section 9.3(b) have been fulfilled;

(iii) to the Company, the written resignations of all of the directors and officers of Acquiror and Merger Sub (other than those Persons identified as the initial directors and officers, respectively, of Acquiror after the Effective Time, in accordance with the provisions of Section 2.7 and Section 7.6), effective as of the Effective Time;

(iv) to the Company, the Registration Rights Agreement duly executed by Acquiror and the "Existing Holders" (as defined therein);

(v) to the Company, the Note Agreement duly executed by the Sponsors; and

(vi) a valid and duly executed IRS Form W-9 for each Sponsor.

(c) On the Closing Date, the Surviving Corporation shall pay or cause to be paid by wire transfer of immediately available funds, (A) subject to Section 2.4(a), all accrued and unpaid Acquiror Transaction Expenses, to the respective payees thereof, as set forth in the Acquiror Closing Statement prepared in accordance with Section 2.4(a) above and (B) all accrued and unpaid Company Transaction Expenses, to the respective payees thereof, as set forth in the Company Closing Statement prepared in accordance with Section 2.4(b)(i) above, which in the case of (A) and (B) shall include the respective amounts and wire transfer instructions for the payment thereof, together with corresponding invoices for the foregoing (clauses (A) and (B) collectively, "Unpaid Transaction Expenses"), *provided, that* any Unpaid Transaction Expenses due to current or former employees, independent contractors, officers, or directors of the Company or any of its Subsidiaries shall be paid to the Company for further payment to such employee, independent contractor, officer or director through the Company's payroll and subject to any applicable withholdings.

Section 2.6. Governing Documents.

(a) The certificate of incorporation and bylaws of the Company in effect immediately prior to the Effective Time, shall be the certificate of incorporation and bylaws of the Surviving Corporation until thereafter amended as provided therein and under the DGCL.

(b) At the Closing and immediately prior to the Effective Time, the Amended and Restated Certificate of Incorporation of the Acquiror dated August 5, 2021 and the Bylaws of Acquiror shall be amended and restated to the Acquiror Restated Charter and the Acquiror Restated Bylaws, respectively (with such changes as may be agreed in writing by Acquiror and the Company), until thereafter amended as provided therein and under the DGCL.

Section 2.7. Directors and Officers.

(a) The directors and officers of the Company set forth on Section 2.7(a) of the Company Disclosure Letter, shall be the directors and officers of the Surviving Corporation from and after the Effective Time, in each case, each to hold office in accordance with the Governing Documents of the Surviving Corporation.

(b) The parties shall take all actions necessary to ensure that, from and after the Effective Time, the Persons identified as the initial post-Closing directors and officers of Acquiror in accordance with the provisions of Section 2.7(b) shall be the directors and officers (and in the case of such officers, holding such positions as are set forth on Section 2.7(b) of the Company Disclosure Letter), respectively, of Acquiror, each to hold office in accordance with the Governing Documents of Acquiror.

Section 2.8. Intended Tax Treatment. The parties intend that, for United States federal income tax purposes, the Merger qualifies as a "reorganization" within the meaning of Section 368(a) of the Code, to which each of Acquiror, Merger Sub and the Company are parties under Section 368(b) of the Code and the Treasury Regulations and as a transaction that qualifies under Section 351 of the Code, and this Agreement is intended to be, and is adopted as, a plan of reorganization for purposes of Sections 354, 361 and the 368 of the Code and within the meaning of Treasury Regulations Section 1.368-2(g) (collectively, the "Intended Tax Treatment"). None of the parties knows of any fact or circumstance, or has taken or will take any action, if such fact, circumstance or action would be reasonably expected to cause the Merger to fail to qualify for the Intended Tax Treatment. The Merger shall be reported by the parties for all applicable Tax purposes in accordance with the foregoing, unless otherwise required by a Governmental Authority as a result of a "determination" within the meaning of Section 1313(a) of the Code. Each of the parties agrees to use reasonable best efforts to promptly notify all other parties of any challenge to the Intended Tax Treatment by any Governmental Authority. The parties shall reasonably cooperate with each other and their respective counsel to document and support the Tax treatment of the Merger consistent with the Intended Tax Treatment, including providing factual support letters or customary representation letters.

ARTICLE III

**EFFECTS OF THE MERGER ON THE COMPANY CAPITAL STOCK,
COMPANY OPTIONS, COMPANY WARRANTS, MERGER SUB CAPITAL STOCK AND ACQUIROR UNITS**

Section 3.1. Conversion of Securities.

(a) After giving effect to the Company Warrant Exercise, the Company shall (notwithstanding anything to the contrary herein, but subject to the receipt of the Company Stockholder Approval) take all actions necessary or appropriate to effect the Company Preferred Conversion immediately prior to the Effective Time. All of the shares of Company Preferred Stock converted into shares of Company Common Stock shall no longer be outstanding and shall cease to exist, and each holder of Company Preferred Stock shall thereafter cease to have any rights with respect to such shares of Company Preferred Stock. Notwithstanding anything herein that may read to the contrary, immediately prior to the Effective Time and after giving effect to the Company Warrant Exercise, all Company Preferred Stock shall automatically (and without any action on the part of any holder of Company Preferred Stock) be converted to Company Common Stock pursuant to the Company Preferred Conversion and the only Company Capital Stock shall be Company Common Stock.

(b) At the Effective Time (after giving effect to the consummation of the Company Warrant Exercise and the Company Preferred Conversion), by virtue of the Merger and without any action on the part of any holder of Company Common Stock, each share of Company Common Stock that is issued and outstanding immediately prior to the Effective Time (*other than* any Dissenting Shares) shall be canceled and converted into the right to receive the applicable portion of the Aggregate Closing Date Merger Consideration as determined pursuant to Section 3.1(d).

(c) At the Effective Time, by virtue of the Merger and without any action on the part of Acquiror or Merger Sub, each share of Merger Sub Capital Stock, shall be converted into a share of common stock, par value \$0.0001 of the Surviving Corporation.

(d) Each holder of issued and outstanding shares of Company Common Stock (after giving effect to the consummation of the Company Warrant Exercise and the Company Preferred Conversion) as of immediately prior to the Effective Time (*other than* in respect of Dissenting Shares) shall be entitled to receive a portion of the Aggregate Closing Date Merger Consideration equal to (A) the Exchange Ratio, *multiplied by* (B) the number of shares of Company Common Stock held by such holder as of immediately prior to the Effective Time, with fractional shares rounded down to the nearest whole share.

(e) Notwithstanding anything in this Agreement to the contrary, no fractional shares of Acquiror Common Stock and no more than one hundred percent (100%) of the Aggregate Closing Date Merger Consideration shall be issued in the Merger.

Section 3.2. Exchange Procedures.

(a) Prior to the Closing the Company shall take commercially reasonable steps to cause the Company Common Stock evidenced by share certificates (the "Company Certificates") to be returned to the Company and replaced with electronic statements or book entry form evidencing such shares of Company Common Stock; *provided that* if such Company Certificates are lost, stolen, or destroyed, the owner of such lost, stolen, or destroyed Company Certificates shall make an affidavit of that fact and shall indemnify Acquiror against any claim that may be made against Acquiror or the Surviving Corporation with respect to the Company Certificates alleged to have been lost, stolen or destroyed as a condition to the issuance of electronic statements or book entry form of shares the owner of such lost, stolen or destroyed Company Certificates. Further, any shares of Company Common Stock issued or issuable by the Company in connection with the Company Preferred Conversion or exercise of Company Warrants hereunder shall be issued in electronic or book entry form. At the Closing, Acquiror shall instruct its transfer agent (reasonably acceptable to the Company) (the "Transfer Agent") to issue the Aggregate Closing Date Merger Consideration to the record holders of shares of Company Capital Stock, Company Options, and Company Warrants entitled to receive a portion of the Aggregate Closing Date Merger Consideration (other than Dissenting Shares) in book-entry form, and the electronic or book entry positions representing the Company Common Stock shall be cancelled.

(b) All shares of Acquiror Common Stock issued in accordance with the terms hereof shall be deemed to have been issued in full satisfaction of all rights pertaining to the Company Common Stock and there shall be no further registration of transfers on the records of the Surviving Corporation of the shares of Company Common Stock that were outstanding immediately prior to the Effective Time. If, after the Effective Time, shares of Company Common Stock are presented to the Surviving Corporation for any reason, they shall be canceled and exchanged as provided in this [Section 3.2](#).

(c) None of Acquiror, Merger Sub, the Company, the Surviving Corporation or the Transfer Agent shall be liable to any Person in respect of any of the Aggregate Closing Date Merger Consideration delivered to a public official pursuant to and in accordance with any applicable abandoned property, escheat or similar Laws. If any such shares shall not have not been transferred immediately prior to such date on which any amounts payable pursuant to this [Article III](#) would otherwise escheat to or become the property of any Governmental Authority, any such amounts shall, to the extent permitted by applicable Law, become the property of the Surviving Corporation, free and clear of all claims or interest of any Person previously entitled thereto.

(d) After the date that is one year after the Effective Time, the Transfer Agent shall return to Acquiror, upon the Acquiror's written request, any portion of the Aggregate Closing Date Merger Consideration that remains unclaimed, and any Person that was a holder of shares of Company Common Stock as of immediately prior to the Effective Time that has not exchanged such shares of Company Common Stock for an applicable portion of the Aggregate Closing Date Merger Consideration in accordance with this [Section 3.2](#) prior to the date that is one year after the Effective Time, may transfer such shares of Company Common Stock to Acquiror and (subject to applicable abandoned property, escheat and similar Laws) receive in consideration therefor, and Acquiror shall promptly deliver, such applicable portion of the Aggregate Closing Date Merger Consideration without any interest thereupon. None of Acquiror, Merger Sub, the Company, the Surviving Corporation or the Transfer Agent shall be liable to any Person in respect of any of the Aggregate Closing Date Merger Consideration delivered to a public official pursuant to and in accordance with any applicable abandoned property, escheat or similar Laws. If any such shares shall not have not been transferred immediately prior to such date on which any amounts payable pursuant to this [Article III](#) would otherwise escheat to or become the property of any Governmental Authority, any such amounts shall, to the extent permitted by applicable Law, become the property of the Surviving Corporation, free and clear of all claims or interest of any Person previously entitled thereto.

Section 3.3. Treatment of Company Options and Company Warrants.

(a) Each Company Option that is outstanding immediately prior to the Effective Time, without regard to the identity of the holder, shall be assumed as of the Effective Time and each such Company Option shall be converted into the right to receive, an option to purchase shares of Acquiror Common Stock upon substantially the same terms and conditions as are in effect with respect to such option immediately prior to the Effective Time, including with respect to vesting and termination-related provisions (each, an "Acquiror Replacement Option") except that (a) such Acquiror Replacement Option shall provide the right to purchase that whole number of shares of Acquiror Common Stock (rounded down to the nearest whole share) equal to the number of shares of Company Common Stock subject to such Company Option, multiplied by the Exchange Ratio and (b) the exercise price per share for each such Acquiror Replacement Option shall be equal to the exercise price per share of such Company Option in effect immediately prior to the Effective Time, divided by the Exchange Ratio (the exercise price per share, as so determined, being rounded up to the nearest full cent); *provided, however, that* the conversion of the Company Options will be made in a manner consistent with Treasury Regulation Sections 1.424-1, such that such conversion will not constitute a "modification" of such Company Options for purposes of Section 409A or Section 424 of the Code. As of the Effective Time, all Company Options shall no longer be outstanding and each holder of Company Options shall cease to have any rights with respect to such Company Options, except as set forth in this Section 3.3(a).

(b) The Company, the Board of Directors, and the compensation committee, as applicable, shall adopt any resolutions and take any other necessary actions, effective as of immediately prior to the Closing, in order to (i) cancel the remaining unallocated share reserve under the Company Incentive Plans and provide that shares in respect of Company Options that for any reason become re-eligible for future issuance, shall be cancelled, and (ii) provide that no new Company Options will be granted under the Company Incentive Plans.

(c) After giving effect to the Company Warrant Exercise, each Company Warrant that remains outstanding immediately prior to the Effective Time shall be cancelled and converted into a warrant to purchase Acquiror Common Stock on the same terms and conditions (including as to vesting and exercisability) as are in effect with respect to such Company Warrant immediately prior to the Effective Time (each, a "Acquiror Replacement Warrant"), except that (i) such Acquiror Replacement Warrant shall entitle the holder thereof to purchase such number of Acquiror Common Stock as is equal to the sum of the product of (x) the number of Company Common Stock or Company Preferred Stock (on an as-converted basis) subject to such Company Warrant immediately prior to the Effective Time multiplied by (y) the Exchange Ratio and (ii) such Acquiror Replacement Warrant shall have an exercise price per share (which shall be rounded up to the nearest whole cent) equal to the quotient of (A) the exercise price per share of such Company Warrant in effect immediately prior to the Effective Time divided by (B) the Exchange Ratio. The exercise of any Company Warrants that are exercisable for shares of Company Preferred Stock shall occur immediately prior to the conversion contemplated by Section 3.1(a).

Section 3.4. Withholding. Notwithstanding any other provision to this Agreement, Acquiror, the Company and its Subsidiaries and the Transfer Agent, as applicable, shall be entitled to deduct and withhold from any amount payable pursuant to this Agreement such Taxes that are required to be deducted and withheld from such amounts under the Code or any other applicable Law (as reasonably determined by Acquiror, the Company or its Subsidiaries, or the Transfer Agent, respectively); *provided, that*, other than with respect to a payment payable to employees of the Company or its Subsidiaries in connection with the Merger that is treated as compensation, Acquiror shall provide the Company with at least five (5) days prior written notice of any amounts that it intends to withhold and/or deduct in connection with any payment to be made by it pursuant to this Agreement. The parties shall reasonably cooperate with each other in good faith to reduce or eliminate any applicable withholding and/or deduction (including through the request and provision of any statements, forms or other documents to reduce or eliminate any such deduction or withholding). To the extent that any amounts are so deducted and withheld, (i) such deducted and withheld amounts shall be timely remitted to the appropriate Governmental Authority and (ii) such timely remitted amounts shall be treated for all purposes of this Agreement as having been paid to the Person in respect of which such deduction and withholding was made. In the case of any such payment payable to employees of the Company or its Subsidiaries in connection with the Merger is treated as compensation, the parties shall cooperate to pay such amounts through the Company's or the relevant Subsidiary's payroll to facilitate applicable withholding.

Section 3.5. Dissenting Shares. Notwithstanding any provision of this Agreement to the contrary, shares of Company Common Stock issued and outstanding immediately prior to the Effective Time and held by a holder who has not voted in favor of adoption of this Agreement or consented thereto in writing and who is entitled to demand and has properly exercised appraisal rights of such shares in accordance with Section 262 of the DGCL and otherwise complied with all of the provisions of the DGCL relevant to the exercise and perfection of dissenters' rights (such shares of Company Common Stock being referred to collectively as the "Dissenting Shares" until such time as such holder fails to perfect or otherwise waives, withdraws, or loses such holder's appraisal rights under the DGCL with respect to such shares) shall not be converted into a right to receive a portion of the Aggregate Closing Date Merger Consideration, but instead shall be entitled to only such rights as are granted by Section 262 of the DGCL; *provided, however, that* if, after the Effective Time, such holder fails to perfect, waives, withdraws, or loses such holder's right to appraisal pursuant to Section 262 of the DGCL, or if a court of competent jurisdiction shall determine that such holder is not entitled to the relief provided by Section 262 of the DGCL, such shares of Company Common Stock shall be treated as if they had been converted as of the Effective Time into the right to receive the Aggregate Closing Date Merger Consideration in accordance with Section 3.1 without interest thereon, upon transfer of such shares. The Company shall provide Acquiror prompt written notice of any demands received by the Company for appraisal of shares of Company Common Stock, any waiver or withdrawal of any such demand, and any other demand, notice, or instrument delivered to the Company prior to the Effective Time that relates to such demand. Except with the prior written consent of Acquiror (which consent shall not be unreasonably conditioned, withheld, delayed or denied), the Company shall not make any payment with respect to, or settle, or offer to settle, any such demands.

Section 3.6. Acquiror Units. At the Effective Time, each Acquiror Unit outstanding immediately prior to the Effective Time shall be automatically detached and the holder thereof shall be deemed to hold one share of Acquiror Common Stock and one-half of an Acquiror Warrant in accordance with the terms of the applicable Acquiror Unit, which underlying shares of Acquiror Common Stock and Acquiror Warrants shall be adjusted in accordance with the applicable terms of this Section 3.6.

Section 3.7. Cancellation of the Purchased Equity. At the Effective Time, the Purchased Equity shall be cancelled on the books and records of the Acquiror.

ARTICLE IV

REPRESENTATIONS AND WARRANTIES OF THE COMPANY

Except as set forth in the disclosure letter delivered to Acquiror and Merger Sub by the Company on the date of this Agreement (the "Company Disclosure Letter") (each section of which, subject to Section 11.8, qualifies the correspondingly numbered and lettered representations in this Article IV), the Company represents and warrants to Acquiror and Merger Sub as follows:

Section 4.1. Company Organization. The Company has been duly incorporated and is validly existing under the Laws of its jurisdiction of incorporation or organization, and has the requisite corporate power and authority to own, lease or operate all of its properties and assets and to conduct its business as it is now being conducted, except as would not have a material adverse effect on the Company, and has all necessary approvals from Governmental Authority to own, lease and operate its properties and to carry on its business as it is now being conducted, except where the failure to have all necessary approvals would not have, individually or in the aggregate, a material adverse effect on the Company and its Subsidiaries, taken as a whole. The Governing Documents of the Company, as amended to the date of this Agreement and as previously made available by or on behalf of the Company to Acquiror, are true, correct and complete. The Company is duly licensed or qualified and in good standing as a foreign corporation in each jurisdiction in which its ownership of property or the character of its activities is such as to require it to be so licensed or qualified, as applicable, except where the failure to be so licensed or qualified would not reasonably be expected to have, individually or in the aggregate, a material adverse effect on the Company and its Subsidiaries, taken as a whole.

Section 4.2. Subsidiaries. The Subsidiaries of the Company as of the date of this Agreement are set forth on Section 4.2 of the Company Disclosure Letter. The Subsidiaries of the Company have been duly formed or organized and are validly existing under the Laws of their jurisdiction of incorporation or organization and have the power and authority to own, lease or operate all of their respective properties and assets and to conduct their respective businesses as they are now being conducted, except as would not have a material adverse effect on the Company and its Subsidiaries, taken as a whole, and have all necessary approvals from Governmental Authorities to own, lease and operate their properties and to carry on their business as it is now being conducted, except where the failure to have all necessary approvals would not have, individually or in the aggregate, a material adverse effect on the Company and its Subsidiaries, taken as a whole. Each Subsidiary of the Company is duly licensed or qualified and in good standing as a foreign corporation (or other entity, if applicable) in each jurisdiction in which its ownership of property or the character of its activities is such as to require it to be so licensed or qualified or in good standing, as applicable, except where the failure to be so licensed or qualified or in good standing would not have, individually or in the aggregate, a material adverse effect on the Company and its Subsidiaries, taken as a whole. The respective jurisdiction of incorporation or organization of each the Company's Subsidiaries is identified on Section 4.2 of the Company Disclosure Letter.

(a) Other than the Company Stockholder Approvals, the Company has the requisite corporate power and authority to execute and deliver this Agreement and the other documents to which it is a party contemplated hereby and (subject to the approvals described in Section 4.5) to consummate the transactions contemplated hereby and thereby and to perform all of its obligations hereunder and thereunder. The execution and delivery of this Agreement and the other documents to which the Company is a party contemplated hereby and the consummation of the transactions contemplated hereby and thereby have been duly authorized by the Board of Directors of the Company, and, except as set forth on Section 4.3(a) of the Company Disclosure Letter, no other company or corporate proceeding on the part of the Company is necessary to authorize this Agreement and the other documents to which the Company is a party contemplated hereby. This Agreement has been, and on or prior to the Closing, the other documents to which the Company is a party contemplated hereby will be, duly and validly executed and delivered by the Company and this Agreement constitutes, and on or prior to the Closing, the other documents to which the Company is a party contemplated hereby will constitute, a legal, valid and binding obligation of the Company, enforceable against the Company in accordance with its terms, subject to applicable bankruptcy, insolvency, fraudulent conveyance, reorganization, moratorium and similar Laws affecting creditors' rights generally and subject, as to enforceability, to general principles of equity, whether such enforceability is considered in a proceeding in equity or at Law.

(b) On or prior to the date of this Agreement, the Board of Directors of the Company has duly adopted resolutions (i) determining that this Agreement and the other documents to which the Company is a party contemplated hereby and the transactions contemplated hereby and thereby are advisable and fair to, and in the best interests of, the Company and its stockholders, as applicable, and (ii) authorizing and approving the execution, delivery and performance by the Company of this Agreement and the other documents to which the Company is a party contemplated hereby and the transactions contemplated hereby and thereby. No other corporate action is required on the part of the Company or any of its stockholders to enter into this Agreement or the documents to which the Company is a party contemplated hereby or to approve the Merger other than the Company Stockholder Approvals. The Company Stockholder Approvals will be sufficient (and as a result of the shareholders who have signed the Company Holders Support Agreement, no other favorable vote or consent of any other stockholder of the Company will be required) to approve this Agreement, the Merger and the other transactions in accordance with the terms of the Company's Governing Documents and any other organizational documents of the Company.

Section 4.4. No Conflict. Subject to the receipt of the consents, approvals, authorizations and other requirements set forth in Section 4.5 and except as set forth on Section 4.4 of the Company Disclosure Letter, the execution and delivery by the Company of this Agreement and the documents to which the Company is a party contemplated hereby and the consummation of the transactions contemplated hereby and thereby do not and will not (a) violate or conflict with any provision of, or result in the breach of, or default under the Governing Documents of the Company, (b) violate or conflict with any provision of, or result in the breach of, or default under any Law or Governmental Order applicable to the Company or any of the Company's Subsidiaries, (c) violate or conflict with any provision of, or result in the breach of, result in the loss of any right or benefit, or cause acceleration, or constitute (with or without due notice or lapse of time or both) a default (or give rise to any right of termination, cancellation or acceleration) under any Contract of the type described in Section 4.12(a) to which the Company or any of the Company's Subsidiaries is a party or by which the Company or any of the Company's Subsidiaries may be bound, or terminate or result in the termination of any such foregoing Contract or (d) result in the creation of any Lien (other than Permitted Liens) upon any of the properties or assets of the Company or any of the Company's Subsidiaries, except, in the case of clauses (b) through (d), to the extent that the occurrence of the foregoing would not reasonably be expected to have, individually or in the aggregate, a Company Material Adverse Effect.

Section 4.5. Governmental Authorities; Consents. Assuming the truth and completeness of the representations and warranties of Acquiror and Merger Sub contained in this Agreement, except as set forth in Section 4.5 of the Company Disclosure Letter, no consent, waiver, approval or authorization of, or designation, declaration or filing with, or notification to, any Governmental Authority (each, a "Governmental Authorization") is required on the part of the Company or its Subsidiaries with respect to the Company's execution or delivery of this Agreement or the consummation by the Company of the transactions contemplated hereby, except for (i) applicable requirements of the HSR Act; (ii) any consents, approvals, authorizations, designations, declarations, waivers or filings, the absence of which would not, individually or in the aggregate, reasonably be expected to have a material adverse effect on the ability of the Company to perform or comply with on a timely basis any material obligation of the Company under this Agreement or to consummate the transactions contemplated hereby and (iii) the filing of the Merger Certificate in accordance with the DGCL.

(a) As of the date of this Agreement, the authorized capital stock of the Company consists of (x) 260,000,000 shares of Company Common Stock, par value \$0.0001 per share, of which 21,627,464 shares are issued and outstanding as of the date of this Agreement, (y) 199,145,285 shares of Preferred Stock, par value \$0.0001 per share, designated as follows: (i) 378,066 shares of Series A-1 Preferred Stock, of which 378,066 shares are issued and outstanding as of the date of this Agreement, (ii) 639,773 shares of Series A-2 Preferred Stock, of which 639,773 shares are issued and outstanding as of the date of this Agreement, (iii) 1,998,177 shares of Series A-3 Preferred Stock, of which 1,998,177 shares are issued and outstanding as of the date of this Agreement, (iv) 2,447,023 shares of Series A-4 Preferred Stock, of which 2,447,023 shares are issued and outstanding as of the date of this Agreement, (v) 7,985,151 shares of Series B-1 Preferred Stock, of which 7,985,151 shares are issued and outstanding as of the date of this Agreement, (vi) 746,602 shares of Series B-2 Preferred Stock, of which 746,602 shares are issued and outstanding as of the date of this Agreement, (vii) 6,627,558 shares of Series B-3 Preferred Stock, of which 6,627,558 shares are issued and outstanding as of the date of this Agreement, (viii) 30,739,072 shares of Series B-4 Preferred Stock, of which 30,739,072 shares are issued and outstanding as of the date of this Agreement, (ix) 27,079,195 shares of Series C Preferred Stock, of which 26,014,749 shares are issued and outstanding as of the date of this Agreement, (x) 38,659,789 shares of Series C-1 Preferred Stock, of which 38,659,789 shares are issued and outstanding as of the date of this Agreement (the shares described in the foregoing clauses (i) through (x), collectively, the "Company Series ABC Preferred Stock"), (xi) 49,342,160 shares of Series D Preferred Stock, of which 49,342,160 shares are issued and outstanding as of the date of this Agreement (the "Company Series D Preferred Stock"), and (xii) 36,861,678 shares of Series E Preferred Stock, of which 33,567,165 shares are issued and outstanding as of the date of this Agreement (the "Company Series E Preferred Stock") and together with both the Company Series ABC Preferred Stock and the Company Series D Preferred Stock, the "Company Preferred Stock"). All of the issued and outstanding shares of Company Capital Stock (A) have been duly authorized and validly issued and are fully paid and non-assessable, including that all amounts provided for in any agreements for the purchase of shares of the Company have been fully paid and such shares have been issued prior to the date hereof unless disclosed in Section 4.6(a) of the Company Disclosure Letter; (B) have been offered, sold and issued in compliance with applicable Law, including federal and state securities Laws, and all requirements set forth in (1) the Governing Documents of the Company and (2) any other applicable Contracts governing the issuance of such securities; (C) are not subject to, nor have they been issued in violation of, any purchase option, call option, right of first refusal, preemptive right, subscription right or any similar right under any provision of any applicable Law, the Governing Documents of the Company or any Contract to which the Company is a party or otherwise bound; and (D) are free and clear of any Liens, other than Securities Liens.

(b) Section 4.6(b) of the Company Disclosure Letter sets forth a true and complete list of the outstanding Company Warrants, the full legal name of each holder of such Company Warrant, the number of shares of Company Common Stock comprised thereof or subject thereto, the date on which such Company Warrant was granted. All outstanding Company Warrants (i) have been duly authorized and validly issued and constitute valid and binding obligations of the Company, enforceable against the Company in accordance with their terms, subject to applicable bankruptcy, insolvency, fraudulent conveyance, reorganization, moratorium and similar Laws affecting creditors' rights generally and subject, as to enforceability, to general principles of equity; (ii) have been offered, sold and issued in compliance with applicable Law, including federal and state securities Laws, and all requirements set forth in (1) the Governing Documents of the Company and (2) any other applicable Contracts governing the issuance of such securities; and (iii) are not subject to, nor have they been issued in violation of, any purchase option, call option, right of first refusal, preemptive right, subscription right or any similar right under any provision of any applicable Law, the Governing Documents of the Company or any Contract to which the Company is a party or otherwise bound; (iv) are free and clear of any Liens, other than Securities Liens; and (v) are currently exercisable by the holder thereof.

(c) As of the date of this Agreement, Company Options to purchase 19,141,496 shares of Company Common Stock are outstanding. The Company has provided a true and complete list of the name of each current or former employee, consultant or director of the Company or any of its Subsidiaries who, as of the date of this Agreement, holds a Company Option, the number of shares of Company Common Stock comprised thereof or subject thereto, vesting schedule, the date on which such Company Option was granted, the number of shares subject to the Company Option which have vested and the number of shares subject to the Company Option which have not yet vested as of the date of this Agreement and as of the Effective Time (as a result of the transactions contemplated by the Agreement), and, if applicable, the exercise price thereof. All Company Options are evidenced by award agreements in substantially the forms previously made available to Acquiror, and no Company Option is subject to terms that are materially different from those set forth in such forms. Each Company Option was validly granted or issued and properly approved by, the Board of Directors of the Company (or appropriate committee thereof). Each Company Option has been granted with an exercise price that is intended to be no less than the fair market value of the underlying Company Common Stock on the date of grant, as determined in accordance with Section 409A of the Code or Section 422 of the Code, if applicable.

(d) Except as otherwise set forth in Section 4.6(d) of the Company Disclosure Letter, the Company has not granted, authorized, or issued any outstanding subscriptions, options, stock appreciation rights, warrants, rights or other securities (including debt securities) convertible into or exchangeable or exercisable for shares of Company Capital Stock, any other commitments, calls, conversion rights, rights of exchange or privilege (whether preemptive, contractual or by matter of Law), plans or other agreements of any character providing for the issuance of additional shares, the sale of treasury shares or other equity interests, or for the repurchase or redemption of shares or other equity interests of the Company or the value of which is determined by reference to shares or other equity interests of the Company, and there are no voting trusts, proxies or agreements of any kind which may obligate the Company to issue, purchase, register for sale, redeem or otherwise acquire any shares of Company Capital Stock. There are no outstanding contractual obligations of the Company or any Company Subsidiary to repurchase, redeem or otherwise acquire any shares of the Company or any capital stock of any Company Subsidiary or to provide funds to or make any investment (in the form of a loan, capital contribution or otherwise) in any person other than a Company Subsidiary.

Section 4.7. Capitalization of Subsidiaries

(a) The outstanding shares of capital stock or equity interests of each of the Company's Subsidiaries (i) have been duly authorized and validly issued, are, to the extent applicable, fully paid and non-assessable, including that all amounts provided for in any agreements for the purchase of shares of the Company have been fully paid and such shares have been issued prior to the date hereof unless disclosed in Section 4.7(a) of the Company Disclosure Letter; (ii) have been offered, sold and issued in compliance with applicable Law, including federal and state securities Laws, and all requirements set forth in (1) the Governing Documents of each such Subsidiary, and (2) any other applicable Contracts governing the issuance of such securities; (iii) are not subject to, nor have they been issued in violation of, any purchase option, call option, right of first refusal, preemptive right, subscription right or any similar right under any provision of any applicable Law, the Governing Documents of each such Subsidiary or any Contract to which each such Subsidiary is a party or otherwise bound; and (iv) are free and clear of any Liens, other than Securities Liens.

(b) Except as set forth on Section 4.7(b) of the Company Disclosure Letter, the Company, directly or indirectly, owns of record and beneficially all the issued and outstanding shares of capital stock or equity interests of such Subsidiaries free and clear of any Liens other than Permitted Liens.

(c) Except as set forth on Section 4.7(b) of the Company Disclosure Letter, there are no outstanding subscriptions, options, warrants, rights or other securities (including debt securities) exercisable or exchangeable for any capital stock of such Subsidiaries, any other commitments, calls, conversion rights, rights of exchange or privilege (whether pre-emptive, contractual or by matter of Law), plans or other agreements of any character providing for the issuance of additional shares, the sale of treasury shares or other equity interests, or for the repurchase or redemption of shares or other equity interests of such Subsidiaries or the value of which is determined by reference to shares or other equity interests of the Subsidiaries, and there are no voting trusts, proxies or agreements of any kind which may obligate any Subsidiary of the Company to issue, purchase, register for sale, redeem or otherwise acquire any of its capital stock. Except as set forth on Section 4.7(b) of the Company Disclosure Letter, the Company does not own any other equity interests in any person.

Section 4.8. Financial Statements.

(a) Attached as Section 4.8(a) of the Company Disclosure Letter are true and complete copies of (i) the audited consolidated balance sheets and statements of operations, comprehensive loss, stockholders' equity and cash flows of the Company and its Subsidiaries as of and for the years ended December 31, 2021 and December 31, 2020, each updated and audited in accordance with the auditing standards of the PCAOB by a nationally recognized independent registered public accounting firm selected by Company (collectively, the "PCAOB Audited Financial Statements") together with the auditor's report / opinion thereon and (ii) the unaudited consolidated balance sheets and statements of operations, comprehensive loss, stockholders' equity, and cash flows of the Company and its Subsidiaries as of and for (a) the three (3)-month period ending March 31, 2022 (the "Q1 Financial Statements") and (b) the six (6)-month period ended June 30, 2022 (the "Q2 Financial Statements") and the PCAOB Audited Financial Statements, Q1 Financial Statements and the Q2 Financial Statements, together with any Updated Interim Financial Statements when delivered pursuant to Section 6.3(a), the "Financial Statements").

(b) Except as set forth on Section 4.8(b) of the Company Disclosure Letter, the PCAOB Audited Financial Statements, the Q1 Financial Statements, the Q2 Financial Statements and, when delivered pursuant to Section 6.3(a), the Updated Interim Financial Statements, (i) fairly present in all material respects the consolidated financial position of the Company and its consolidated Subsidiaries, as at the respective dates thereof, and the consolidated results of their operations, their consolidated incomes, their consolidated changes in stockholders' equity (with respect to the PCAOB Audited Financial Statements only) and their consolidated cash flows for the respective periods then ended (subject, in the case of the Q1 Financial Statements, the Q2 Financial Statements and the Updated Interim Financial Statements, to normal year-end adjustments), (ii) were prepared in conformity with GAAP applied on a consistent basis during the periods involved (except as may be indicated in the notes thereto and, in the case of the Q1 Financial Statements, the Q2 Financial Statements and the Updated Interim Financial Statements, the absence of footnotes or the inclusion of limited footnotes), (iii) were prepared from, and are in accordance in all material respects with, the books and records of the Company and its consolidated Subsidiaries, (iv) for the PCAOB Audited Financial Statements, were audited and prepared in accordance with the PCAOB standards, and (v) when delivered by the Company for inclusion in the Registration Statement for filing with the SEC following the date of this Agreement in accordance with Section 6.3, will comply in all material respects with the applicable accounting requirements and with the rules and regulations of the SEC, the Exchange Act and the Securities Act applicable to a registrant, in effect as of the respective dates thereof.

(c) Except as set forth on Section 4.8(c) of the Company Disclosure Letter, as of the date of this Agreement, neither the Company (including, to the knowledge of the Company, any director, officer or employee thereof) nor any independent auditor of the Company has identified or been made aware of (i) any significant deficiency or material weakness in the system of internal accounting controls utilized by the Company, (ii) any fraud, whether or not material, that involves the Company's management or other employees who have a role in the preparation of financial statements or the internal accounting controls utilized by the Company or (iii) any claim or allegation regarding any of the foregoing.

(d) All accounts receivable of the Company and the Company Subsidiaries reflected on the Financial Statements or arising thereafter have arisen from bona fide transactions and in accordance with GAAP and are collectible, subject to allowance for doubtful accounts and bad debts reserved in the Financial Statements. To the knowledge of the Company, such accounts receivables are not subject to valid defenses, setoffs or counterclaims, other than routine credits granted for errors in ordering, shipping, pricing, discounts, rebates, returns in the ordinary course of business and other similar matters. The Company's respective reserves for doubtful accounts, contractual allowance and warranty claims are adequate in all material respects and have been calculated in a manner consistent with past practices. On and after January 1, 2021, neither the Company nor any of the Company Subsidiaries has modified or changed in any material respect its sales practices or methods, including such practices or methods in accordance with which the Company or any of the Company Subsidiaries sell goods, fill orders or record sales.

(e) All accounts payable of the Company and the Company Subsidiaries reflected on the Financial Statements or arising thereafter are the result of bona fide transactions and have been paid or are not yet due or payable. On and after January 1, 2021, the Company and the Company Subsidiaries have not altered in any material respects their practices for the payment of such accounts payable, including the timing of such payment.

Section 4.9. Undisclosed Liabilities. Except as set forth on Section 4.9 of the Company Disclosure Letter, as of the date of this Agreement neither the Company nor any of its Subsidiaries has any liability, debt or obligation, whether accrued, contingent, absolute, determined or determinable, in each case of the nature required to be disclosed on a balance sheet in accordance with GAAP, except for liabilities, debts or obligations (a) reflected or reserved for on the Financial Statements or disclosed in the notes thereto, (b) that have arisen since the date of the most recent balance sheet included in the Financial Statements in the ordinary course of business of the Company and its Subsidiaries, (c) arising under this Agreement and/or performance by the Company of its obligations hereunder, including transaction expenses, (d) that are disclosed in the Company Disclosure Letter or (e) that would not reasonably be expected to have, individually or in the aggregate, a material adverse effect on the Company and its subsidiaries, taken as a whole.

Section 4.10. Litigation and Proceedings. Except as set forth on Section 4.10 of the Company Disclosure Letter, as of the date of this Agreement, (a) there are no material pending or, to the knowledge of the Company, threatened in writing Actions against the Company or any of the Company's Subsidiaries or their respective properties or assets; and (b) there is no outstanding Governmental Order imposed upon the Company or any of the Company's Subsidiaries; nor are any properties or assets of the Company or any of the Company's Subsidiaries' respective businesses bound or subject to any Governmental Order.

Section 4.11. Legal Compliance.

(a) As of the date of this Agreement, each of the Company and its Subsidiaries is in compliance with all applicable Laws in all material respects.

(b) Except as set forth on Section 4.11(b) of the Company Disclosure Letter, since January 1, 2020, neither the Company nor any of its Subsidiaries has received any written notice of, or been charged with, the violation of any Laws would not, individually or in the aggregate, be expected to have, individually or in the aggregate, a Company Material Adverse Effect.

Section 4.12. Contracts: No Defaults.

(a) Section 4.12(a) of the Company Disclosure Letter contains a listing of all Contracts described in clauses (i) through (xv) below to which, as of the date of this Agreement, the Company or any of the Company's Subsidiaries is a party, other than a Company Benefit Plan. True, correct and complete copies of the Contracts listed on Section 4.12(a) of the Company Disclosure Letter, including any amendments to such Contracts, have been delivered to or made available to Acquiror by posting such Contracts to the VDR.

(i) Each Contract that the Company reasonably anticipates will involve aggregate payments or consideration furnished (A) by the Company or by any of its Subsidiaries of more than \$2,500,000 or (B) to the Company or to any of its Subsidiaries of more than \$2,500,000, in each case, on a calendar year basis;

(ii) Each mortgage, indenture, note or financing agreement or instrument or other Contract for money borrowed by the Company or any of the Company's Subsidiaries, in each case, in excess of \$2,500,000, each contract that is a currency or hedging arrangement, each other type of Contract evidencing Indebtedness, and any pledge agreements, security agreements or other collateral agreements in which the Company or any of its Subsidiaries granted to any person a security interest in or Lien on any of the property or assets of the Company or any of its Subsidiaries, and all agreements or instruments guaranteeing the debts or other obligations of any other Person;

(iii) Each Contract with outstanding obligations that provides for the sale or purchase of personal property, fixed assets or real property and involves aggregate payments in excess of \$2,500,000 in any calendar year, other than (A) sales or purchase agreements in the ordinary course of business and/or (B) sales of equipment deemed by the Company in its reasonable business judgement to be obsolete or no longer be material to the business of the Company and its Subsidiaries;

(iv) Each Contract that is a definitive purchase and sale or similar agreement for the acquisition of any Person or any business unit thereof or the disposition of any material assets of the Company or any of its Subsidiaries on or after January 1, 2020, in each case, involving payments in excess of \$2,500,000 other than Contracts (A) in which the applicable acquisition or disposition has been consummated and there are no material obligations ongoing or (B) between the Company and its Subsidiaries;

(v) All broker, distributor, dealer, manufacturer's representative, franchise, agency, sales promotion, market research, management or advisory services contracts (excluding contracts for employment), marketing consulting and advertising contracts and agreements to which the Company or any Subsidiary of the Company is a party with consideration payable to or by the Company or any Subsidiary of the Company of more than \$2,500,000 in any calendar year;

(vi) Each Contract involving the formation of a (A) joint venture, (B) partnership, or (C) limited liability company (excluding, in the case of clauses (B) and (C), any Subsidiary of the Company);

(vii) Contracts expressly prohibiting or restricting the ability of the Company or its Subsidiaries to engage in any business in any material respect, to operate in any geographical area or during any period of time in any material respect or to compete with any Person in any line of business in any material respect, in each case, other than customary non-solicitation and no-hire provisions entered into in the ordinary course of business;

(viii) Each employee collective bargaining Contract between the Company or any of the Company's Subsidiaries, on one hand, and any labor union or other body representing employees of the Company or any of the Company's Subsidiaries, on the other hand;

(ix) Each Intellectual Property Contract (including license agreements, coexistence agreements, and agreements with covenants not to sue, but excluding non-disclosure agreements entered into in the ordinary course of business and non-exclusive Trademark licenses incidental to marketing, printing, or advertising Contracts) pursuant to which the Company or any of the Company's Subsidiaries (A) grants to a third Person the right to use or license material Intellectual Property of the Company and its Subsidiaries (other than Contracts granting nonexclusive rights to use Company products or services entered into in the ordinary course of business), or (B) is granted by a third Person the right to use or license Intellectual Property that is material to the business of the Company and its Subsidiaries (other than Contracts granting nonexclusive rights to use commercially available software or services with annual aggregate fees of less than \$200,000 and Open Source Licenses);

(x) Each Contract requiring capital expenditures by the Company or any of the Company's Subsidiaries after the date of this Agreement in an amount in excess of \$2,500,000 in any calendar year;

(xi) Each Contract with any Governmental Authority;

(xii) Each Contract (A) under which the Company or any its Subsidiaries has agreed to purchase goods or services from a vendor, supplier or other person on a preferred supplier or "most favored supplier" basis or (B) that the Company or any of its Subsidiaries is subject to that grants to any third Person (1) "most favored customer" pricing status or price matching rights or (2) other price guarantees, in each case, that involves aggregate payments in excess of \$2,500,000 in any calendar year;

(xiii) Each Contract involving the payment of royalties or other amounts calculated based upon the revenues or income of the Company or any of its Subsidiaries or income or revenues related to any product or service of the Company or any of its Subsidiaries that involves aggregate payments in excess of \$2,500,000 in any calendar year;

(xiv) Each Contract that results in any Person holding a power of attorney from the Company or any Subsidiary of the Company that materially relates to the Company or any Subsidiary of the Company or materially impacts the business of the Company or any Subsidiary of the Company; and

(xv) Any outstanding written commitment to enter into any Contract of the type described in subsections (i) through (xv) of this Section 4.12(a) or any other Contract that is material to the Company and its Subsidiaries taken as a whole.

(b) Except for any Contract that has terminated (with such termination expressly stated on Section 4.12(a) in the Company Disclosure Letter) and except as would not reasonably be expected to, individually or in the aggregate, be material to the Company and its Subsidiaries, taken as a whole, as of the date of this Agreement, all of the Contracts listed pursuant to Section 4.12(a) in the Company Disclosure Letter represent the legal, valid and binding obligations of the Company or the Subsidiary of the Company party thereto. As of the date of this Agreement, except, in each case, where such Contract is not material to the Company and its Subsidiaries taken as a whole and where the occurrence of such breach or default or failure to perform would not reasonably be expected to be, individually or in the aggregate, a material adverse effect on the Company and its Subsidiaries taken as a whole, (x) none the Company, the Company's Subsidiaries, or, to the knowledge of the Company, any other party thereto is in breach of or default under any such Contract, (y) since January 1, 2020, neither the Company nor any of its Subsidiaries has received any written claim or written notice of termination or breach of or default under any such Contract and (z) no event has occurred which individually or together with other events, would reasonably be expected to result in a material breach of or a material default under any such Contract by the Company or its Subsidiaries or to the knowledge of the Company, any other party thereto (in each case, with or without notice or lapse of time or both).

Section 4.13. Company Benefit Plans.

(a) Section 4.13(a) of the Company Disclosure Letter sets forth a complete list, as of the date hereof, of each material Company Benefit Plan. For purposes of this Agreement, a “Company Benefit Plan” means an “employee benefit plan” as defined in Section 3(3) of the Employee Retirement Income Security Act of 1974, as amended, (“ERISA”) or any other plan, policy, program or agreement (including any employment, bonus, incentive or deferred compensation, equity or equity-based compensation, severance, retention, supplemental retirement, change in control, welfare benefit, fringe benefit or similar plan, policy, program or agreement) providing compensation or other benefits to any current or former director, officer, individual consultant, worker or employee, which are maintained, sponsored or contributed to by the Company or any of the Company’s Subsidiaries, or to which the Company or any of the Company’s Subsidiaries is a party or has or may have any liability, and in each case whether or not (i) subject to the Laws of the United States, (ii) in writing or (iii) funded, but excluding in each case any statutory plan, program or arrangement that is required under applicable Law and maintained by any Governmental Authority. With respect to each material Company Benefit Plan, the Company has made available to Acquiror, to the extent applicable, true, complete and correct copies of (A) such Company Benefit Plan (or, if not written a written summary of its material terms) and all plan documents, trust agreements, insurance Contracts or other funding vehicles and all amendments thereto, (B) the most recent summary plan descriptions, including any summary of material modifications (C) the most recent annual reports (Form 5500 series) filed with the IRS with respect to such Company Benefit Plan, (D) the most recent actuarial report or other financial statement relating to such Company Benefit Plan, (E) the most recent determination or opinion letter, if any, issued by the IRS with respect to any Company Benefit Plan and any pending request for such a determination letter, and (F) any material, non-routine correspondence with any Governmental Authority with respect to the Company Benefit Plans.

(b) Except as set forth on Section 4.13(b) of the Company Disclosure Letter, (i) each Company Benefit Plan has been operated and administered in compliance with its terms and all applicable Laws, including ERISA and the Code, except where the failure to comply would not be, or would not reasonably be expected to have, individually or in the aggregate, a material adverse effect on the Company or its Subsidiaries; (ii) all material contributions required to be made with respect to any Company Benefit Plan on or before the date hereof have been made and all obligations in respect of each Company Benefit Plan as of the date hereof have been accrued and reflected in the Company’s financial statements to the extent required by GAAP; (iii) each Company Benefit Plan which is intended to be qualified within the meaning of Section 401(a) of the Code has received a favorable determination or opinion letter from the IRS as to its qualification or may rely upon an opinion letter for a prototype plan and, to the knowledge of the Company, no fact or event has occurred that would reasonably be expected to adversely affect the qualified status of any such Company Benefit Plan except where the failure to be so qualified would not reasonably be expected to result, individually or in the aggregate, in material liability to the Company or its Subsidiaries.

(c) No Company Benefit Plan is a multiemployer pension plan (as defined in Section 3(37) of ERISA) (a “Multiemployer Plan”) or other pension plan that is subject to Title IV of ERISA (“Title IV Plan”), and neither the Company nor any of its ERISA Affiliates has sponsored or contributed to, been required to contribute to, or had any actual or contingent liability under, a Multiemployer Plan or Title IV Plan at any time within the previous six (6) years. Neither the Company nor any of its ERISA Affiliates has incurred any withdrawal liability under Section 4201 of ERISA that has not been fully satisfied.

(d) No Company Benefit Plan provides medical, surgical, hospitalization, death or similar benefits (whether or not insured) for employees or former employees of the Company or any Subsidiary for periods extending beyond their retirement or other termination of service, other than (i) coverage mandated by applicable Law, (ii) death benefits under any “pension plan,” or (iii) benefits the full cost of which is borne by the current or former employee (or his or her beneficiary).

(e) Except as set forth on Section 4.13(g) of the Company Disclosure Letter, the consummation of the transactions contemplated hereby will not, either alone or in combination with another event (such as termination following the consummation of the transactions contemplated hereby), (i) entitle any current or former employee, officer or other service provider of the Company or any Subsidiary of the Company to any severance pay or any other compensation payable by the Company or any Subsidiary of the Company, except as expressly provided in this Agreement, or (ii) accelerate the time of payment, funding or vesting, or increase the amount of compensation due to any such employee, officer or other individual service provider by the Company or a Subsidiary of the Company. The consummation of the transactions contemplated hereby will not, either alone or in combination with another event, result in any “excess parachute payment” under Section 280G of the Code. No Company Benefit Plan provides for a Tax gross-up, make whole or similar payment with respect to the Taxes imposed under Sections 409A or 4999 of the Code.

Section 4.14. Labor Relations: Employees.

(a) Except as set forth on Section 4.14(a) of the Company Disclosure Letter, (i) neither the Company nor any of its Subsidiaries is a party to or bound by any collective bargaining agreement, or any similar agreement, (ii) no such agreement is being negotiated by the Company or any of the Company’s Subsidiaries, and (iii) no labor union or any other employee representative body has requested or, to the knowledge of the Company, has sought to represent any of the employees of the Company or its Subsidiaries. To the knowledge of the Company, there has been no labor organization activity involving any employees of the Company or any of its Subsidiaries. Since January 1, 2020, there has been no actual or, to the knowledge of the Company, threatened strike, slowdown, work stoppage, lockout or other material labor dispute against or affecting the Company or any Subsidiary of the Company.

(b) Each of the Company and its Subsidiaries (i) are, and have been during the last three years, in compliance with all applicable Laws respecting labor and employment including, but not limited to, all Laws respecting terms and conditions of employment, health and safety, wages and hours, holiday pay and the calculation of holiday pay, working time, employee classification (with respect to both exempt vs. non-exempt status and employee vs. independent contractor and worker status), child labor, immigration, employment discrimination, disability rights or benefits, equal opportunity and equal pay, plant closures and layoffs, affirmative action, workers' compensation, labor relations, employee leave issues and unemployment insurance, and (ii) have withheld and reported all amounts required by any legal requirement to be withheld and reported with respect to wages, salaries and other payments or compensation to any Company employee or other service provider, and (iii) have no liability for any arrears of wages or any penalty for failure to comply with any of the foregoing, except in each case of prongs (i)-(iii) where failure to comply would not reasonably be expected to result, individually or in the aggregate, in material liability to the Company or its Subsidiaries, taken as a whole.

(c) During the last three years, the Company and its Subsidiaries have not received (i) notice of any unfair labor practice charge or material complaint pending or threatened before the National Labor Relations Board or any other Governmental Authority against them, (ii) notice of any complaints, grievances or arbitrations arising out of any collective bargaining agreement or any other complaints, grievances or arbitration procedures against them, (iii) notice of any material charge or complaint with respect to or relating to them pending before the Equal Employment Opportunity Commission or any other Governmental Authority responsible for the prevention of unlawful employment practices, (iv) notice of the intent of any Governmental Authority responsible for the enforcement of labor, employment, wages and hours of work, child labor, immigration, or occupational safety and health Laws to conduct an investigation with respect to or relating to them or notice that such investigation is in progress, or (v) notice of any material complaint, lawsuit or other proceeding pending or threatened in any forum by or on behalf of any present or former employee of such entities, any applicant for employment or classes of the foregoing alleging breach of any express or implied Contract of employment, any applicable Law governing employment or the termination thereof or other discriminatory, wrongful or tortious conduct in connection with the employment relationship.

(d) To the knowledge of the Company, no present or former employee, worker or independent contractor of the Company or any of the Company's Subsidiaries' is in material violation of (i) any restrictive covenant, nondisclosure obligation or fiduciary duty to the Company or any of the Company's Subsidiaries or (ii) any restrictive covenant or nondisclosure obligation to a former employer or engager of any such individual relating to (A) the right of any such individual to work for or provide services to the Company or any of the Company's Subsidiaries' or (B) the knowledge or use of Trade Secrets or proprietary information.

(e) Since January 1, 2020, the Company and its Subsidiaries have not engaged in layoffs, furloughs or employment terminations sufficient to trigger application of the Workers' Adjustment and Retraining Notification Act or any similar state or local law relating to group terminations or effected any broad-based salary or other compensation or benefits reductions, in each case, whether temporary or permanent.

(f) To the knowledge of the Company, (i) no allegations of harassment, discrimination or misconduct have been made against any officer or director of the Company or its Subsidiaries, and (ii) the Company and its Subsidiaries have not entered into any settlement agreement or conducted any investigation related to allegations of harassment, discrimination or misconduct by a director, officer, employee, contractor or other agent of the Company or its Subsidiaries.

(g) Except as would not reasonably be expected to result, individually or in the aggregate, in material liability to the Company or its Subsidiaries, the Company is, and for the last three (3) years has been, in compliance in all respects with the requirements of the Immigration Reform Control Act of 1986.

Section 4.15. Taxes.

(a) All income and other material Tax Returns required to be filed by the Company or any of its Subsidiaries have been filed (taking into account any applicable extensions), all such Tax Returns (taking into account all amendments thereto) are true, complete and accurate in all material respects, and all material Taxes due and payable (whether or not shown on any Tax Return) by the Company and its Subsidiaries have been paid, other than Taxes being contested in good faith and for which appropriate reserves have been established in accordance with GAAP.

(b) The Company and each of its Subsidiaries have withheld from amounts owing to any employee, creditor or other Person all material amounts of Taxes required by Law to be withheld, paid over to the proper Governmental Authority all such withheld amounts required to have been so paid over and complied in all material respects with all other applicable withholding and related reporting requirements with respect to such Taxes.

(c) There are no Liens for any material amounts of Taxes (other than Permitted Liens) upon the property or assets of the Company or any of its Subsidiaries.

(d) No claim, assessment, deficiency or proposed adjustment for any material amount of Tax has been asserted or assessed by any Governmental Authority against the Company or any of its Subsidiaries that remains unresolved or unpaid, except for claims, assessments, deficiencies or proposed adjustments being contested in good faith and for which appropriate reserves have been established in accordance with GAAP.

(e) There is no material Tax audit or other examination of the Company or any of its Subsidiaries presently in progress, and there are no waivers, extensions or requests for any waivers or extensions of any statute of limitations currently in effect with respect to any material Taxes of the Company or any of its Subsidiaries.

(f) Neither the Company nor any of its Subsidiaries has made a request for an advance tax ruling, request for technical advice or any similar request that is in progress or pending with any Governmental Authority with respect to any Taxes that would reasonably be expected to be material to the Company and its Subsidiaries, taken as a whole.

(g) Neither the Company nor any of its Subsidiaries is a party to any Tax indemnification or Tax sharing or similar agreement (other than any such agreement solely between the Company and its Subsidiaries and customary commercial Contracts (or Contracts entered into in the ordinary course of business) not primarily related to Taxes).

(h) Neither the Company nor any of its Subsidiaries has been a party to any transaction treated by the parties as a distribution of stock qualifying for tax-deferred treatment under Section 355 or Section 361 of the Code since January 1, 2020.

(i) Neither the Company nor any of its Subsidiaries (A) is liable for material amounts of Taxes of any other Person (other than the Company and its Subsidiaries) under Treasury Regulation Section 1.1502-6 or any similar provision of state, local or foreign Tax Law or as a transferee or successor or by Contract (other than customary commercial Contracts (or Contracts entered into in the ordinary course of business) not primarily related to Taxes) or (B) has ever been a member of an affiliated, consolidated, combined or unitary group filing for U.S. federal, state or local income Tax purposes, other than a group the common parent of which was or is the Company or any of its Subsidiaries.

(j) No written claim has been made by any Governmental Authority on or after January 1, 2021 where the Company or any of its Subsidiaries does not file Tax Returns that it is or may be subject to material taxation in that jurisdiction.

(k) Neither the Company nor any of its Subsidiaries has participated in a "listed transaction" within the meaning of Treasury Regulation 1.6011-4(b)(2).

(l) Neither the Company nor any of its Subsidiaries will be required to include any material amount in taxable income, exclude any material item of deduction or loss from taxable income, or make any adjustment under Section 481 of the Code (or any similar provision of state, local or foreign Law) for any taxable period (or portion thereof) beginning after the Closing Date as a result of any (i) installment sale or open transaction disposition made by the Company or its Subsidiaries prior to the Closing outside the ordinary course of business, (ii) prepaid amount received or deferred revenue recognized by the Company or its Subsidiaries prior to the Closing outside the ordinary course of business, (iii) change in method of accounting of the Company or its Subsidiaries for a taxable period ending on or prior to the Closing Date made prior to the Closing, (iv) "closing agreement" described in Section 7121 of the Code (or any similar provision of state, local or foreign Law) executed by the Company or its Subsidiaries prior to the Closing (other than any such agreement executed in compliance with [Section 6.1](#)), or (v) election under Section 965(h) of the Code.

(m) The Company has not knowingly taken any action, nor, to the knowledge of the Company or any of its Subsidiaries, are there any facts or circumstances, that would reasonably be expected to prevent the Merger from qualifying for the Intended Tax Treatment.

(n) The Company has not been a “United States real property holding corporation” within the meaning of Section 897(c)(2) of the Code during the applicable period specified in Section 897(c)(1)(A)(ii) of the Code.

(o) Neither the Company nor any Subsidiary of the Company has received written notice from a non-U.S. Tax authority that it has a permanent establishment (within the meaning of an applicable Tax treaty) or otherwise has an office or fixed place of business in a country, in each case, other than the country in which it is organized.

(p) For U.S. federal income tax purposes, the Company is, and has been since the date of the Company’s formation, classified as a corporation. Section 4.15(p) of the Company Disclosure Letter sets forth the current entity classification for each Subsidiary of the Company for U.S. federal income tax purposes, any prior classification of such Subsidiary, and the date of any such change.

(q) Neither the Company nor any Subsidiary of the Company has made an election to defer the payment of any “applicable employment taxes” under Section 2302 of the Coronavirus Aid, Relief, and Economic Security Act (Pub. L. 116-136) or made any such deferral or election pursuant to the Memorandum on Deferring Payroll Tax Obligations in Light of the Ongoing COVID-19 Disaster, dated August 8, 2020.

Notwithstanding any representation or warranty in this Agreement (including the representations and warranties set forth in this Section 4.15), no representation or warranty is being made as to the use or availability of any Tax attribute or credit of the Company or any of its Subsidiaries in any taxable period (or portion thereof) beginning on the day immediately after the Closing Date.

Section 4.16. Brokers’ Fees. Except as set forth on Section 4.16 of the Company Disclosure Letter, no broker, finder, investment banker or other Person is entitled to any brokerage fee, finders’ fee or other commission in connection with the transactions contemplated hereby based upon arrangements made by the Company, any of the Company’s Subsidiaries’ or any of their Affiliates for which Acquiror, the Company or any of the Company’s Subsidiaries has any obligation.

Section 4.17. Insurance. As of the date of this Agreement: (a) all material insurance policies and bonds (collectively, "Policies") held by, or for the benefit of, the Company or any of its Subsidiaries with respect to policy periods that include the date of this Agreement are in full force and effect, (b) true, correct, and complete copies of the Policies have previously been made available to Acquiror, (c) except as disclosed on Section 4.17 of the Company Disclosure Letter, neither the Company nor any of its Subsidiaries has received a written notice of cancellation of any of the Policies or of any changes that are required in the conduct of the business of the Company or any of its Subsidiaries as a condition to the continuation of coverage under, or renewal of, any of the Policies, (d) except as would not reasonably be expected to result, individually or in the aggregate, in material liability to the Company and its Subsidiaries, taken as a whole, neither the Company nor any Company Subsidiary is in breach or default (including any such breach or default with respect to the payment of premiums or the giving of notice), and no event has occurred which, with notice or the lapse of time, would constitute such a breach or default, or permit termination or modification, under the policy, (e) to the knowledge of the Company, no insurer on the policy has been declared insolvent or placed in receivership, conservatorship or liquidation, (f) all premiums and other charges due have been paid, (g) none of the Policies or their predecessors have been written on an audited, retrospective, or similar premium basis; and (h) none of the Policies or their predecessors have been written or reinsured on a fronting, captive, or similar self-insured basis. Section 4.17 of the Company Disclosure Letter sets forth, with respect to each Policy (i) the names of the insurer and the first named insured, (ii) the policy number, (iii) the policy period (iv) the type of coverage, (v) the aggregate limits; and (vi) the premium most recently charged. To the knowledge of the Company, all material occurrences, circumstances, and claims potentially covered under any of the Policies or their predecessors have been timely noticed. To the knowledge of the Company, with regard to any such material noticed occurrence, circumstance, or claim that is related to an ongoing or potentially ongoing matter, no insurer has denied or questioned coverage.

Section 4.18. Licenses. The Company and its Subsidiaries has all material licenses, approvals, consents, registrations and permits of a Governmental Authority (the "Licenses") reasonably required to permit the Company and its Subsidiaries to own, lease or operate their properties and assets in the manner in which they are now operated and to conduct the business of the Company and its Subsidiaries as currently conducted, except where the failure to obtain such Licenses has not had, or would not reasonably be expected to have, individually or in the aggregate, have a materially adverse impact on the Company and its Subsidiaries taken as a whole. The Company and its Subsidiaries have obtained all of the Licenses necessary under applicable Laws to permit the Company and its Subsidiaries to own, operate, use and maintain their assets in the manner in which they are now operated and maintained and to conduct the business and operations of the Company and its Subsidiaries as currently conducted. The operation of the business of the Company and its Subsidiaries as currently conducted is not in material violation of, nor is the Company or any of its Subsidiaries in material default or material violation under, any License. No suspension or cancellation of any of the Licenses is pending or, to the knowledge of the Company, threatened.

Section 4.19. Equipment and Other Tangible Property. Except as set forth on Section 4.19 of the Company Disclosure Letter, the Company or one of its Subsidiaries owns and has good title to all material equipment and other tangible property reflected on the books of the Company and its Subsidiaries as owned by the Company or one of its Subsidiaries, free and clear of all Liens other than Permitted Liens, other than as would not have a material adverse effect, individually or in the aggregate, on the Company and its Subsidiaries, taken as a whole.

Section 4.20. Real Property.

(a) Section 4.20(a) of the Company Disclosure Letter sets forth a true, correct and complete list as of the date of this Agreement of all Leased Real Property and all Real Property Leases pertaining to such Leased Real Property. With respect to each parcel of Leased Real Property:

- (i) The Company or one of its Subsidiaries holds a good and valid leasehold estate in such Leased Real Property, free and clear of all Liens, except for Permitted Liens.
- (ii) The Company and/or its Subsidiaries have made available to Acquiror true, correct and complete copies of the material Contracts (including all material modifications and amendments thereto) pursuant to which the Company or any of its Subsidiaries occupy (or have been granted an option to occupy) the Leased Real Property or is otherwise a party with respect to the Leased Real Property (the "Real Property Leases").
- (iii) There are no contractual or legal restrictions that preclude or restrict the ability of the Company or any Company Subsidiary to use any Leased Real Property by such party for the purposes for which it is currently being used, except as would not, individually or in the aggregate, be material to the Company and the Company Subsidiaries, taken as a whole. To the knowledge of the Company, there are no material latent defects or adverse physical conditions affecting the Leased Real Property.
- (iv) All such Real Property Leases are in full force and effect, are valid and enforceable in accordance with their respective terms, and there is not, under any of such Real Property Leases, any existing default (or event which, with notice or lapse of time, or both, would constitute a default) by the Company or any Company Subsidiary or, to the Company's knowledge, by the other party to such Real Property Leases, except as would not, individually or in the aggregate, be material to the Company and the Company Subsidiaries, taken as a whole. To the Company's knowledge, there are no material disputes with respect to such Real Property Leases.
- (v) As of the date of this Agreement, no party, other than the Company or its Subsidiaries, has any right to use, occupy or possess the Leased Real Property or any portion thereof.
- (vi) Neither the Company nor any of its Subsidiaries have received written notice of any current condemnation proceeding or proposed similar Action or agreement for taking in lieu of condemnation with respect to any portion of the Leased Real Property.

Section 4.21. Intellectual Property.

(a) Section 4.21(a)(i) of the Company Disclosure Letter lists each item of Intellectual Property that is registered and applied-for with a Governmental Authority or Domain Name registrar and is owned by the Company or any of the Company's Subsidiaries as of the date of this Agreement (collectively, the "Company Registered Intellectual Property") and (i) for each Patent, the patent number or application serial number for each jurisdiction in which filed, date issued and filed and present status thereof, (ii) for each Trademark, each applicable application serial number or registration number, by country, province and state, and the class of goods or services covered, the nature of the goods or services, the date issued and filed and the present status thereof, (iii) for each Domain Name, the registration date, (iv) for each Copyright, each applicable number and date of such registration or Copyright application by country, province and state, and (v) for each registered design, the registration number or application serial number for each jurisdiction in which filed, date issued and filed and present status thereof. Section 4.21(a)(ii) of the Company Disclosure Letter lists each item of material Company Software, excluding Company Software that the Company and its Subsidiaries have not licensed or distributed in the ordinary course of business to third parties (other than as installed on hardware products sold by or on behalf of the Company or any of its Subsidiaries). The Company or one of the Company's Subsidiaries is the sole and exclusive owner of all of the items of Company Registered Intellectual Property, and, to the knowledge of the Company as of the date of this Agreement, all such Company Registered Intellectual Property (excluding any pending applications, declarations or renewals included in the Company Registered Intellectual Property) is valid and enforceable.

(b) Except as set forth on Section 4.21(b) of the Company Disclosure Letter, the Company or one of its Subsidiaries owns, free and clear of all Liens (other than Permitted Liens), or has a valid right to use, all Intellectual Property reasonably necessary for the continued conduct of the business of the Company and its Subsidiaries in substantially the same manner as such business has been operated since January 1, 2020; *provided, that* the foregoing shall not be deemed a representation or warranty regarding non-infringement, validity, or enforceability of Intellectual Property.

(c) Except as set forth on Section 4.21(c) of the Company Disclosure Letter, as of the date of this Agreement, there is not, and since January 1, 2020 there has not been, any Action pending to which the Company or any of the Company's Subsidiaries is a named party, or to the knowledge of the Company, that is threatened in writing, alleging the Company's or any of its Subsidiaries' infringement, misappropriation or other violation of any Intellectual Property of any third Person. To the knowledge of the Company, the operation of the business of the Company and its Subsidiaries has not, since January 1, 2020, and does not, materially infringe, misappropriate or violate, any Intellectual Property of any other Person. Except as set forth on Section 4.21(e) of the Company Disclosure Letter or as would not reasonably be expected to have a material adverse effect on the business of the Company and its Subsidiaries, to the knowledge of the Company, no other Person has, since January 1, 2020, infringed, misappropriated or violated any of the Intellectual Property owned by the Company or any of its Subsidiaries.

(d) The Company and each of its Subsidiaries take commercially reasonable measures to protect the confidentiality of Trade Secrets included in their Intellectual Property that are material to the business of the Company and its Subsidiaries. To the knowledge of the Company as of the date of this Agreement, there has not been any unauthorized disclosure of or unauthorized access to any Trade Secrets of the Company or any of the Company's Subsidiaries to or by any Person in a manner that has resulted in the misappropriation of, or loss of Trade Secrets or other rights in and to such information, except as would not be expected to result in a material adverse effect on the business of the Company and its Subsidiaries.

(e) Except as would not be expected to result in a material adverse effect on the business of the Company and its Subsidiaries, neither the Company nor any of its Subsidiaries have granted any other Person any exclusive license or exclusive right under or with respect to any Intellectual Property that is material to the business of the Company and its Subsidiaries.

(f) Except as would not be expected to result in a material adverse effect on the business of the Company and its Subsidiaries, neither the Company nor any of its Subsidiaries have made any commitments to any standards-setting bodies, industry groups or other similar organizations (“Standards Organizations”) that would obligate the Company or its Subsidiaries to grant licenses to any Person of any Owned Company Intellectual Property, (ii) neither the Company, its Subsidiaries, nor any Company Patent is subject to any binding membership agreements or bylaws of any Standards Organization with respect to licensing or non-assertion of any Owned Company Intellectual Property, and (iii) to the knowledge of the Company, no Company Patent has been identified by the Company, its Subsidiaries, or any other Person as essential to any Standards Organization or any standard promulgated by any Standards Organization. Neither the Company nor any of its Subsidiaries implement any standard or specifications in any Company products that would require the grant of a Patent license to any Person.

(g) Except as would not be expected to result in a material adverse effect on the business of the Company and its Subsidiaries, no government funding, nor any facilities of a university, college, other educational institution or research center, was used by the Company or any of its Subsidiaries in the development of any material Intellectual Property owned by the Company or any of the Company’s Subsidiaries.

(h) The Company’s and its Subsidiaries’ use and distribution of (i) software owned by the Company or any of the Company’s Subsidiaries (“Company Software”), and (ii) Open Source Materials, is in compliance in all material respects with all Open Source Licenses applicable thereto, except as would not be expected to result in a material adverse effect on the business of the Company and its Subsidiaries. To the knowledge of the Company, as of the date of this Agreement, none of the Company or any Subsidiary of the Company has used any Open Source Materials in a manner that requires any material Company Software to be subject to Copyleft Licenses. To the knowledge of the Company, the Company has not disclosed any material source code for any Company Software to any third Person, other than developers subject to confidentiality obligations.

(i) All Persons who have contributed, developed or conceived any material Intellectual Property for or on behalf of the Company or any of its Subsidiaries have executed valid and enforceable written agreements with the Company or one of the Company Subsidiaries, as applicable, pursuant to which such Persons assigned to the Company or the applicable Subsidiary all of their right, title, and interest in and to such Intellectual Property, without further ongoing consideration or any restrictions or obligations whatsoever, including on the use or other disposition or ownership of such Intellectual Property. To the knowledge of the Company, no Person is in breach of any such agreements.

(j) Except as would not be expected to result in a material adverse effect on the business of the Company and its Subsidiaries, the Company and each of its Subsidiaries owns, leases, licenses, or otherwise has the legal right to use, all Business Systems, and such Business Systems, to the knowledge of the Company, are sufficient in all material respects for the current needs of the business of the Company and the Company Subsidiaries as currently conducted by the Company and the Company Subsidiaries. To the knowledge of the Company, since January 1, 2020, there have not been any failures with respect to any of the Business Systems that are material to the conduct of the Company’s or its Subsidiaries’ businesses that have not been remedied or replaced in all material respects.

Section 4.22. Privacy and Cybersecurity.

(a) The Company, its Subsidiaries, and, to the knowledge of the Company, their Data Processors, comply and have complied for the past three (3) years with Company Privacy Policies and the Privacy Requirements. Neither the execution, delivery, or performance of this Agreement nor any of the other agreements contemplated by this Agreement would violate any Privacy Requirements or Company Privacy Policies.

(b) The Company and its Subsidiaries have established a written Information Security Program that is appropriately implemented and maintained, and there have been no material violations of the Information Security Program for the past three (3) years. The IT Systems currently used by the Company and its Subsidiaries are in good working condition, to the knowledge of the Company do not contain any Malicious Code or defect, and operate and perform as necessary to conduct the business of the Company. All Company Data material to the conducting the business of the Company will continue to be available for Processing by the Company and its Subsidiaries following the Closing on substantially the same terms and conditions as existed immediately before the Closing.

(c) The Company, its Subsidiaries, and, to the knowledge of the Company, their Data Processors, have not suffered and are not suffering a Security Incident, and have not been and are not required to notify any Person or Governmental Authority of any Security Incident. The Company and its Subsidiaries have not received any written notice (including any enforcement notice), letter, or complaint from a Governmental Authority or any Person alleging noncompliance or potential noncompliance with any Privacy Requirements or Company Privacy Policies and have not been subject to any Action relating to noncompliance or potential noncompliance with Privacy Requirements or the Company's and any of its Subsidiaries' Processing of Personal Data. The Company and its Subsidiaries are not in breach or default of any Contracts relating to its IT Systems or to Company Data.

Section 4.23. Environmental Matters. Except as disclosed on Section 4.23 of the Company Disclosure Letter:

(a) The Company and its Subsidiaries are and, for the last three (3) years, have been in compliance in all material respects with all applicable Environmental Laws, except for matters which have been fully resolved.

(b) The Company and its Subsidiaries hold and maintain in compliance in all material respects all material Licenses required under applicable Environmental Laws to own, operate, use and maintain their assets and to conduct the business and operations of the Company and its Subsidiaries in compliance with the applicable Environmental Laws.

(c) There are no written claims or notices of violation pending against or, to the knowledge of the Company, threatened against the Company or its Subsidiaries alleging any violations of or liability under any Environmental Law or any violations or liability concerning any Hazardous Materials, in each case as has resulted or would result in material liabilities to the Company or its Subsidiaries under Environmental Law.

(d) There has been no release of any Hazardous Materials on, in, at, under or from any (i) Leased Real Property; (ii) any property formerly owned, leased or operated by the Company or any Subsidiary or (iii) at any off-site location to which Hazardous Materials generated by the Company or any Subsidiary were sent for treatment, recycling, storage or disposal, in each case, which would reasonably be expected to give rise to material liability to the Company or any Subsidiary, under Environmental Laws.

(e) Notwithstanding anything to the contrary in this Agreement, this Section 4.23 provides the sole and exclusive representations and warranties of the Company in respect of environmental matters, including any and all matters arising under Environmental Laws.

Section 4.24. Absence of Changes. From the date of the Q2 Financial Statements, (a) there has not been any event or occurrence that has had an Company Material Adverse Effect and (b) except as set forth in Section 4.24 of the Company Disclosure Letter, Company and its Subsidiaries have, in all material respects, conducted their business and operated their properties in the ordinary course of business consistent with past practice.

Section 4.25. Related Party Transactions. Except for the Contracts set forth on Section 4.25 of the Company Disclosure Letter, there are no Contracts between the Company or any of its Subsidiaries, on the one hand, and any Affiliate, officer or director of the Company, on the other hand, except in each case, for (a) employment agreements, fringe benefits and other compensation paid to directors, officers and employees consistent with previously established policies, (b) reimbursements of expenses incurred in connection with their employment or service (excluding from clause (a) and this clause (b) any loans made by the Company or its Subsidiaries to any officer, director, employee, member or stockholder and all related arrangements, including any pledge arrangements) and (c) amounts paid pursuant to Company Benefit Plans. Except for employment relationships and the payment of compensation, benefits and expense reimbursements and advances in the ordinary course of business, no director or officer (or Affiliate thereof) of the Company or any Subsidiary of the Company, to the Company's knowledge, has or has had, directly or indirectly: (w) an economic interest in any Person that has furnished or sold, or furnishes or sells, services or products that the Company or any Subsidiary of the Company furnishes or sells, or proposes to furnish or sell; (x) an economic interest in any Person that purchases from or sells or furnishes to, the Company or any Subsidiary of the Company, any goods or services; (y) a beneficial interest in any Contract disclosed in Section 4.12(a) of the Company Disclosure Letter; or (z) any contractual or other arrangement with the Company or any Company Subsidiary, other than customary indemnity arrangements; *provided, however*, that ownership of no more than five percent (5%) of the outstanding voting stock of a publicly traded corporation shall not be deemed an "economic interest in any person" for purposes of this Section 4.25. Other than as set forth on Section 4.25 of the Company Disclosure Letter, the Company and the Company Subsidiaries have not, since the date of the Company's formation, (i) extended or maintained credit, arranged for the extension of credit or renewed an extension of credit in the form of a personal loan to or for any director or executive officer (or equivalent thereof) of the Company or (ii) materially modified any term of any such extension or maintenance of credit.

Section 4.26. Information Supplied. None of the information relating to the Company or its Subsidiaries supplied or to be supplied by the Company or any of the Company's Subsidiaries in writing specifically for inclusion in the Registration Statement or the Proxy Statement will, (a) when the Registration Statement is first filed, (b) on the effective date of the Registration Statement, (c) on the date when the Proxy Statement is mailed to the Acquiror's Voting Stockholders and (d) at the time of the Acquiror's Stockholders' Meeting, contain any untrue statement of a material fact or omit to state any material fact required to be stated therein or necessary in order to make the statements therein, in light of the circumstances under which they are made, not misleading.

Section 4.27. Exchange Act. Neither the Company nor any Subsidiary of the Company is currently (nor has either previously been) subject to the requirements of Section 12 of the Exchange Act.

Section 4.28. Certain Business Practices.

(a) Since the date of the Company's formation, neither the Company nor any of its Subsidiaries, nor any of their respective directors, officers or employees, nor their agents or other third parties (i) is or has been a Sanctioned Person; (ii) has transacted business with or for the benefit of any Sanctioned Person or has otherwise violated applicable Sanctions while acting on behalf of the Company or any Subsidiary of the Company; or (iii) has violated any Ex-Im Laws while acting on behalf of the Company or any Subsidiary of the Company.

(b) Since the date of the Company's formation, the Company and each Company Subsidiary has adopted and maintained adequate policies, procedures, and controls reasonably designed to promote the Company's and its Subsidiaries' compliance with all Anti-Corruption Laws, Ex-Im Laws and Sanctions.

(c) Since the date of the Company's formation, the Company and each Subsidiary has maintained accounting and financial controls adequate to ensure that: (i) all payments and activities have been accurately recorded in the books, records and accounts of the Company and its Subsidiaries; (ii) there have been no false, inaccurate, misleading, or incomplete entries made in the books, records, and accounts of the Company and its Subsidiaries; and (iii) the Company and its Subsidiaries have not established or maintained any secret or unrecorded funds or accounts. The books, records, and accounts of the Company and its Subsidiaries accurately reflect in reasonable detail the character and amount of all transactions, and the Company and its Subsidiaries have not had or maintained any bank or other financial account that is not or was not accurately disclosed in their books, records, and accounts.

(d) Since the date of the Company's formation, neither the Company nor any Company Subsidiary, nor any of their respective directors, officers or employees, nor their agents or other third parties, (i) has undergone and is not currently undergoing any review, investigation, inspection, or examination of records relating to compliance with Anti-Corruption Laws, Ex-Im Laws or Sanctions; (ii) has been, is now under, or has received any communication regarding any actual or potential administrative, civil, or criminal investigation, prosecution, or indictment; and (iii) is not party to any actions involving alleged false statements, false claims, or other improprieties relating to compliance with Anti-Corruption Laws, Ex-Im Laws or Sanctions.

(e) Since the date of the Company's formation, neither the U.S. government nor any other Governmental Authority, nor any other entity or person, has notified the Company or any Company Subsidiary of any actual or alleged violations or breaches of Anti-Corruption Laws, Ex-Im Laws, Sanctions or applicable Laws that prohibit fraud, money laundering, or other improper payments, and neither the Company nor any Company Subsidiary has made any voluntary or involuntary disclosures to a Government Authority.

Section 4.29. No Outside Reliance. Notwithstanding anything contained in this Article IV or any other provision hereof, the Company, and any of its directors, managers, officers, employees, equityholders, partners, members or representatives, acknowledge and agree that the Company has made its own investigation of Acquiror and Merger Sub and that neither Acquiror, Merger Sub nor any of their Affiliates, agents or representatives are making any representation or warranty whatsoever, express or implied, beyond those expressly given by Acquiror and Merger Sub in Article V, including any implied warranty or representation as to condition, merchantability, suitability or fitness for a particular purpose or trade as to any of the assets of the Acquiror or Merger Sub. Without limiting the generality of the foregoing, it is understood that any cost estimates, financial or other projections or other predictions that may be contained or referred to in the Acquiror Disclosure Letter or elsewhere, as well as any information, documents or other materials (including any such materials contained in any "data room" (whether or not accessed by the Company or its representatives) or reviewed by the Company pursuant to the Confidentiality Agreement) or management presentations that have been or shall hereafter be provided to the Company or any of its Affiliates, agents or representatives are not and will not be deemed to be representations or warranties of Acquiror or Merger Sub, and no representation or warranty is made as to the accuracy or completeness of any of the foregoing except as may be expressly set forth in Article V of this Agreement. Except as otherwise expressly set forth in this Agreement, Company understands and agrees that any assets, properties and business of the Acquiror and Merger Sub and their Subsidiaries are furnished "as is", "where is" and subject to and except as otherwise provided in the representations and warranties contained in Article V, with all faults and without any other representation or warranty of any nature whatsoever.

Section 4.30. No Additional Representation or Warranties. The Company acknowledges and agrees that, except as provided in Article V, neither Acquiror nor Merger Sub, nor any of their respective Affiliates, nor any of their respective directors, managers, officers, employees, stockholders, partners, members or representatives has made, or is making, any representation or warranty whatsoever to the Company or any of its Affiliates and no such party shall be liable in respect of the accuracy or completeness of any information provided to the Company or any of its Affiliates. Without limiting the foregoing, the Company acknowledges that the Company and its advisors, have made their own investigation of Acquiror and Merger Sub and, except as provided in ARTICLE V, is not relying on any representation or warranty whatsoever as to the condition, merchantability, suitability or fitness for a particular purpose or trade as to any of the assets of Acquiror or Merger Sub, the prospects (financial or otherwise) or the viability or likelihood of success of the business of Acquiror and its Subsidiaries as conducted after the Closing, as contained in any materials provided by Acquiror, Merger Sub or any of their Affiliates or any of their respective directors, officers, employees, stockholders, partners, members or representatives or otherwise.

ARTICLE V

REPRESENTATIONS AND WARRANTIES OF ACQUIROR AND MERGER SUB

Except as set forth in (i) in the case of Acquiror, any Acquiror SEC Filings filed or submitted on or prior to the date hereof (excluding (a) any disclosures in any risk factors section that do not constitute statements of fact, disclosures in any forward-looking statements disclaimer and other disclosures that are generally cautionary, predictive or forward-looking in nature and (b) any exhibits or other documents appended thereto) (it being acknowledged that nothing disclosed in such Acquiror SEC Filings will be deemed to modify or qualify the representations and warranties set forth in [Section 5.1](#), [Section 5.2](#), [Section 5.8](#), [Section 5.12](#) and [Section 5.17](#)), or (ii) in the case of Acquiror and Merger Sub, in the disclosure letter delivered by Acquiror and Merger Sub to the Company (the "[Acquiror Disclosure Letter](#)") on the date of this Agreement (each section of which, subject to [Section 11.8](#), qualifies the correspondingly numbered and lettered representations in this [Article V](#)), Acquiror and Merger Sub represent and warrant to the Company as follows:

Section 5.1. [Acquiror and Merger Sub Organization](#). Each of Acquiror and Merger Sub has been duly incorporated and is validly existing as a corporation in good standing under the Laws of its jurisdiction of incorporation and has the requisite corporate and authority to own, lease or operate all of its properties and assets and to conduct its business as it is now being conducted. The copies of Acquiror's Governing Documents and the Governing Documents of Merger Sub, in each case, as amended to the date of this Agreement, previously delivered by Acquiror to the Company, are true, correct and complete. Merger Sub has no assets or operations other than those required to effect the transactions contemplated hereby. All of the equity interests of Merger Sub are held directly by Acquiror. Each of Acquiror and Merger Sub is duly licensed or qualified and in good standing as a foreign corporation in all jurisdictions in which its ownership of property or the character of its activities is such as to require it to be so licensed or qualified, except where failure to be so licensed or qualified would not reasonably be expected to be, individually or in the aggregate, material to Acquiror.

(a) Each of Acquiror and Merger Sub has all requisite corporate power and authority to (a) execute and deliver this Agreement and the documents contemplated hereby, and (b) consummate the transactions contemplated hereby and thereby and perform all obligations to be performed by it hereunder and thereunder. The execution and delivery of this Agreement and the documents contemplated hereby and the consummation of the transactions contemplated hereby and thereby have been (i) duly and validly authorized and approved by the Board of Directors of Acquiror (including by a majority of the independent directors of Acquiror) and Merger Sub and by Acquiror as the sole stockholder of Merger Sub and (ii) determined by the Board of Directors of Acquiror as advisable to Acquiror and the Acquiror Stockholders and recommended for approval by the Acquiror Voting Stockholders. No other company proceeding on the part of Acquiror or Merger Sub is necessary to authorize this Agreement and the documents contemplated hereby (other than the Acquiror Stockholder Approval). This Agreement has been, and at or prior to the Closing, the other documents contemplated hereby will be, duly and validly executed and delivered by each of Acquiror and Merger Sub, and, assuming due authorization, execution and delivery by the Company, this Agreement constitutes, and at or prior to the Closing, the other documents contemplated hereby will constitute, a legal, valid and binding obligation of each of Acquiror and Merger Sub, enforceable against Acquiror and Merger Sub in accordance with its terms, subject to applicable bankruptcy, insolvency, fraudulent conveyance, reorganization, moratorium and similar Laws affecting creditors' rights generally and subject, as to enforceability, to general principles of equity.

(b) Assuming that a quorum (as determined pursuant to Acquiror's Governing Documents) is present:

(i) the Transaction Proposal identified in clause (A) of Section 8.2(b) shall require approval by the affirmative vote of at least a majority of the outstanding Acquiror Common Stock entitled to vote thereon, voting as a single class, at a stockholders' meeting duly called by the Board of Directors of Acquiror and held for such purpose; and

(ii) each of those Transaction Proposals identified in clauses (B), (C), (D), and, if necessary, (H), of Section 8.2(b), in each case, shall require approval by an affirmative vote of at least a majority of the votes cast by holders of outstanding Acquiror Common Stock entitled to vote thereon, voting as a single class at a stockholders' meeting duly called by the Board of Directors of Acquiror and held for such purpose;

(iii) the Transaction Proposal identified in clause (E) of Section 8.2(b) shall require approval by a plurality of the votes cast by holders of shares Acquiror Common Stock present in person (or virtually) or represented by proxy at the Acquiror Stockholders' Meeting and entitled to vote thereon;

in the case of each of (i) (ii) and (iii), as determined in accordance with the Acquiror's Governing Documents, the DGCL and the rules of the Nasdaq, as applicable.

(iv) Other than, if necessary, votes on those Transaction Proposals identified in clauses (E) and (G) of Section 8.2(b), the foregoing votes are the only votes of any of Acquiror's share capital necessary in connection with entry into this Agreement by Acquiror and Merger Sub and the consummation of the transactions contemplated hereby, including the Closing.

(c) At a meeting duly called and held, the Board of Directors of Acquiror has unanimously approved the transactions contemplated by this Agreement as a Business Combination.

Section 5.3. No Conflict. Subject to the Acquiror Stockholder Approval, the execution and delivery of this Agreement by Acquiror and Merger Sub and the other documents contemplated hereby by Acquiror and Merger Sub and the consummation of the transactions contemplated hereby and thereby do not and will not (a) violate or conflict with any provision of, or result in the breach of or default under the Governing Documents of Acquiror or Merger Sub, (b) assuming that all consents, approvals, authorizations, expiration or termination of waiting periods and other actions, if any, required by the Exchange Act, the Securities Act, "Blue Sky" Laws and state takeover Laws, and the pre-merger notification requirements of the HSR Act have been obtained and all related filings and obligations have been made, violate or conflict with any provision of, or result in the breach of, or default under any applicable Law or Governmental Order applicable to Acquiror or Merger Sub, (c) violate or conflict with any provision of, or result in the loss of any right or benefit, or cause acceleration, or constitute (with or without due notice or lapse of time or both) a default (or give rise to any right of termination, cancellation or acceleration) under any Contract to which Acquiror or Merger Sub is a party or by which Acquiror or Merger Sub may be bound, or terminate or result in the termination of any such Contract or (d) result in the creation of any Lien upon any of the properties or assets of Acquiror or Merger Sub, except, in the case of clauses (h) through (d), to the extent that the occurrence of the foregoing would not (i) have, or would not reasonably be expected to have, individually or in the aggregate, an Acquiror Material Adverse Effect.

Section 5.4. Litigation and Proceedings. As of the date of this Agreement, (a) there are no material pending or, to the knowledge of the Acquiror, threatened in writing Actions against Acquiror or Merger Sub or their respective properties or assets; and (b) except for any applicable COVID-19 Measure, there is no outstanding Governmental Order imposed upon Acquiror or Merger Sub; nor are any properties or assets of Acquiror or Merger Sub's respective businesses bound or subject to any Governmental Order.

Section 5.5. SEC Filings. Acquiror has timely filed or furnished all statements, prospectuses, registration statements, forms, reports and documents required to be filed by it with the SEC since August 5, 2021, pursuant to the Exchange Act or the Securities Act (collectively, as they have been amended since the time of their filing through the date hereof, the "Acquiror SEC Filings"). Each of the Acquiror SEC Filings, as of the respective date of its filing, and as of the date of any amendment, complied in all material respects with the applicable requirements of the Securities Act, the Exchange Act, the Sarbanes-Oxley Act and any rules and regulations promulgated thereunder applicable to the Acquiror SEC Filings. As of the respective date of its filing (or if amended or superseded by a filing prior to the date of this Agreement or the Closing Date, then on the date of such filing), the Acquiror SEC Filings did not contain any untrue statement of a material fact or omit to state a material fact required to be stated therein or necessary to make the statements made therein, in light of the circumstances under which they were made, not misleading. To the knowledge of Acquiror, as of the date hereof, there are no outstanding or unresolved comments in comment letters received from the SEC with respect to the Acquiror SEC Filings. To the knowledge of Acquiror, none of the Acquiror SEC Filings filed on or prior to the date hereof is subject to ongoing SEC review or investigation as of the date hereof.

(a) Except as not required in reliance on exemptions from various reporting requirements by virtue of Acquiror's status as an "emerging growth company" within the meaning of the Securities Act, as modified by the Jumpstart Our Business Startups Act of 2012 ("JOBS Act"), Acquiror has established and maintains disclosure controls and procedures (as defined in Rule 13a-15 under the Exchange Act). Such disclosure controls and procedures are designed to ensure that material information relating to Acquiror, including its consolidated Subsidiaries, if any, is made known to Acquiror's principal executive officer and its principal financial officer by others within those entities, particularly during the periods in which the periodic reports required under the Exchange Act are being prepared. To the knowledge of Acquiror, such disclosure controls and procedures are effective in all material respects in timely alerting Acquiror's principal executive officer and principal financial officer to material information required to be included in Acquiror's periodic reports required under the Exchange Act. Since August 5, 2021, Acquiror has established and maintained a system of internal controls over financial reporting (as defined in Rule 13a-15 under the Exchange Act). To the knowledge of Acquiror, such system of internal controls over financial reporting are sufficient to provide reasonable assurance regarding the reliability of Acquiror's financial reporting and the preparation of Acquiror Financial Statements for external purposes in accordance with GAAP.

(b) To the knowledge of Acquiror, each director and executive officer of Acquiror has filed with the SEC on a timely basis all statements required by Section 16(a) of the Exchange Act and the rules and regulations promulgated thereunder. Acquiror has not taken any action prohibited by Section 402 of the Sarbanes-Oxley Act.

(c) Since August 5, 2021, Acquiror has complied in all material respects with the applicable listing and corporate governance rules and regulations of the Nasdaq Capital Markets ("Nasdaq"). The Acquiror Common Stock is registered pursuant to Section 12(b) of the Exchange Act and is listed for trading on the Nasdaq as of the date hereof. There is no Action pending or, to the knowledge of Acquiror, threatened against Acquiror by the Nasdaq or the SEC with respect to any intention by such entity to deregister the Acquiror Common Stock or prohibit or terminate the listing of Acquiror Common Stock on the Nasdaq.

(d) The Acquiror SEC Filings contain true and complete copies of (x) the audited balance sheet as of December 31, 2021 and December 31, 2020, and audited statement of operations, cash flow and stockholders' equity of Acquiror for the year ended December 31, 2021, December 31, 2020 and the period from February 13, 2019 (inception) through December 31, 2019, together with the auditor's reports thereon (the "Acquiror Audited Financial Statements"), and (y) Acquiror's unaudited condensed balance sheet as of March 31, 2022, June 30, 2022 and September 30, 2022, and the unaudited condensed statements of operations, cash flow, and stockholders' equity of Acquiror for the three months ended March 31, 2022 and March 31, 2021, the three (3) and six (6) months ended June 30, 2022 and June 30, 2021, and the three (3) and nine (9) months ended September 30, 2022 and September 30, 2021 (the "Acquiror Unaudited Financial Statements") and together with the Acquiror Audited Financial Statements, the "Acquiror Financial Statements"). The Acquiror Financial Statements (i) fairly present in all material respects the financial position of Acquiror, as at the respective dates thereof, and the results of operations, income, and cash flows for the respective periods then ended (subject, in the case of Acquiror Unaudited Financial Statements, to normal year-end adjustments), (ii) were prepared in conformity with GAAP applied on a consistent basis during the periods involved (except as may be indicated therein or in the notes thereto or, in the case of Acquiror Unaudited Financial Statements, as permitted by Form 10-Q of the SEC), and (iii) comply in all material respects with the applicable accounting requirements and with the rules and regulations of the SEC, the Exchange Act and the Securities Act in effect as of the respective dates thereof.

(e) There are no outstanding loans or other extensions of credit made by Acquiror to any executive officer (as defined in Rule 3b-7 under the Exchange Act) or director of Acquiror. Acquiror has not taken any action prohibited by Section 402 of the Sarbanes-Oxley Act.

(f) Except as disclosed in the Acquiror SEC Filings, neither Acquiror (including any employee thereof) nor Acquiror's independent auditors has identified or been made aware of (i) any significant deficiency or material weakness in the system of internal accounting controls utilized by Acquiror, (ii) any fraud, whether or not material, that involves Acquiror's management or other employees who have a role in the preparation of financial statements or the internal accounting controls utilized by Acquiror or (iii) any claim or allegation regarding any of the foregoing.

Section 5.7. Governmental Authorities; Consents. Assuming the truth and completeness of the representations and warranties of the Company contained in this Agreement, no consent, waiver, approval or authorization of, or designation, declaration or filing with, or notification to, any Governmental Authority or other Person is required on the part of Acquiror or Merger Sub with respect to Acquiror's or Merger Sub's execution or delivery of this Agreement or any Ancillary Agreement, or the consummation of the transactions contemplated hereby, except for (i) applicable requirements of the HSR Act, the Exchange Act, the Securities Act, "Blue Sky" Laws and state takeover Laws, (ii) the filing of the Merger Certificate in accordance with the DGCL, and (iii) as otherwise disclosed on Section 5.7 of the Acquiror Disclosure Letter.

Section 5.8. Trust Account.

(a) As of the date of this Agreement, Acquiror has at least \$116,700,000 in the Trust Account, maintained by Continental Stock Transfer & Trust Company, a New York corporation, acting as trustee (the "Trustee"), pursuant to the Investment Management Trust Agreement, dated as of August 5, 2021, between Acquiror and Trustee on file as an Acquiror SEC Filing as of the date of this Agreement (the "Trust Agreement"). As of the date of this Agreement, amounts in the Trust Account are invested in United States government securities or in money market funds meeting certain conditions under Rule 2a-7 promulgated under the Investment Company Act pursuant to the Trust Agreement. There are no Contracts, side letters, arrangements or understandings (whether written or unwritten, express or implied) with the Trustee or any other Person that would (i) cause the description of the Trust Agreement in the Acquiror SEC Filings to be inaccurate in any material respect or (ii) entitle any Person (other than (A) stockholders of Acquiror holding Acquiror Common Stock sold in Acquiror's initial public offering who shall have elected to redeem their shares of Acquiror Common Stock pursuant to Acquiror's Governing Documents and the Acquiror Share Redemption and (B) the underwriters of Acquiror's initial public offering with respect to deferred underwriting commissions) to any portion of the proceeds in the Trust Account. Prior to the Closing, none of the funds held in the Trust Account may be released other than payments with respect to all Acquiror Share Redemptions or to pay income and franchise Taxes from any interest income earned in the Trust Account, in each case, in accordance with the Trust Agreement and, Acquiror's Governing Documents. There are no claims or proceedings pending or, to the knowledge of Acquiror, threatened in writing with respect to the Trust Account. Acquiror has performed all material obligations required to be performed by it to date under, and is not in default, breach or delinquent in performance or any other respect (claimed or actual) in connection with, the Trust Agreement, and no event has occurred which, with due notice or lapse of time or both, would constitute a material default or breach thereunder. As of the Effective Time, the obligations of Acquiror to dissolve or liquidate pursuant to Acquiror's Governing Documents shall terminate, and as of the Effective Time, Acquiror shall have no obligation whatsoever pursuant to Acquiror's Governing Documents to dissolve and liquidate the assets of Acquiror by reason of the consummation of the transactions contemplated hereby. Following the Effective Time, no Acquiror Stockholder (in its capacity as an Acquiror Stockholder) shall be entitled to receive any amount from the Trust Account except to the extent such Acquiror Stockholder is exercising an Acquiror Share Redemption. The Trust Agreement is in full force and effect and is a legal, valid and binding obligation of Acquiror and, to the knowledge of Acquiror, enforceable in accordance with its terms. The Trust Agreement has not been terminated, repudiated, rescinded, amended or supplemented or modified, in any respect, and, to the knowledge of Acquiror, no such termination, repudiation, rescission, amendment, supplement or modification is contemplated.

(b) As of the date hereof, assuming the accuracy of the representations and warranties of the Company contained herein and the compliance by the Company with its obligations hereunder, neither Acquiror or Merger Sub have any reason to believe that any of the conditions to the use of funds in the Trust Account will not be satisfied or that the funds available in the Trust Account after payment of all Acquiror Share Redemptions, will not be available to Acquiror and Merger Sub at the Effective Time.

Section 5.9. Investment Company Act; JOBS Act. Acquiror constitutes an "emerging growth company" within the meaning of the JOBS Act. Acquiror is not an "investment company" or a Person directly or indirectly "controlled" by or acting on behalf of an "investment company", in each case within the meaning of the Investment Company Act, so long as Acquiror consummates a Business Combination on or prior to February 5, 2023.

Section 5.10. Absence of Changes. From the date of the most recent balance sheet of Acquiror included the Acquiror SEC Filings prior to the date of this Agreement, (a) there has not been any event or occurrence that has had an Acquiror Material Adverse Effect and (b) except as set forth in Section 5.10 of the Acquiror Disclosure Letter and except as expressly contemplated by this Agreement, Acquiror and Merger Sub have, in all material respects, conducted their business and operated their properties in the ordinary course of business consistent with past practice.

Section 5.11. No Undisclosed Liabilities. Except for any fees and expenses payable by Acquiror or Merger Sub as a result of or in connection with the consummation of the transactions contemplated hereby or as set forth on Section 5.11 of the Acquiror Disclosure Letter, there is no liability, debt or obligation of or claim or judgment against Acquiror or Merger Sub (whether direct or indirect, absolute or contingent, accrued or unaccrued, known or unknown, liquidated or unliquidated, or due or to become due) required to be reflected on a balance sheet prepared in accordance with GAAP, except for liabilities and obligations (i) reflected or reserved for on the financial statements or disclosed in the notes thereto included in Acquiror SEC Filings, (ii) that have arisen since the date of the most recent balance sheet included in the Acquiror SEC Filings in the ordinary course of business of Acquiror and Merger Sub, or (iii) which would not be, or would not reasonably be expected to be, material to Acquiror. The Indebtedness and other unpaid liabilities and obligations of Acquiror or Merger Sub, including any unpaid Acquiror Transaction Expenses, as of the date of this Agreement are set forth on Section 5.11 of the Acquiror Disclosure Letter and to the knowledge of the Acquiror, do not exceed, in the aggregate, the Acquiror Transaction Expenses Cap.

Section 5.12. Capitalization of Acquiror.

(a) As of the date of this Agreement, the authorized share capital of Acquiror consists of 50,000,000 shares of Acquiror Common Stock. As of the date of this Agreement, (i) 14,836,500 shares of Acquiror Common Stock are issued and outstanding, all of which are validly issued, fully paid and non-assessable and not subject to any preemptive rights, (ii) no shares of Acquiror Common Stock are held in the treasury of the Acquiror, (iii) 5,750,000 Acquiror Public Warrants are issued and outstanding and 5,750,000 shares of Acquiror Common Stock are issuable in respect of such Acquiror Public Warrants and (iv) 230,750 Acquiror Private Warrants are issued and outstanding and 230,750 shares of Acquiror Common Stock are issuable in respect of such Acquiror Private Warrants. The foregoing represents all of the issued and outstanding Acquiror Securities as of the date of this Agreement. All issued and outstanding shares of Acquiror Common Stock (i) have been duly authorized and validly issued and are fully paid and non-assessable; (ii) have been offered, sold and issued in compliance with applicable Law, including federal and state securities Laws, and all requirements set forth in (1) Acquiror's Governing Documents, and (2) any other applicable Contracts governing the issuance of such securities; and (iii) are not subject to, nor have they been issued in violation of, any purchase option, call option, right of first refusal, preemptive right, subscription right or any similar right under any provision of any applicable Law, Acquiror's Governing Documents or any Contract to which Acquiror is a party or otherwise bound.

(b) Subject to the terms of conditions of the Warrant Agreement, each Acquiror Warrant will be exercisable beginning thirty (30) days after Closing for one share of Acquiror Common Stock at an exercise price of \$11.50 per share. All outstanding Acquiror Warrants (i) have been duly authorized and validly issued and constitute valid and binding obligations of Acquiror, enforceable against Acquiror in accordance with their terms, subject to applicable bankruptcy, insolvency, fraudulent conveyance, reorganization, moratorium and similar Laws affecting creditors' rights generally and subject, as to enforceability, to general principles of equity; (ii) have been offered, sold and issued in compliance with applicable Law, including federal and state securities Laws, and all requirements set forth in (1) Acquiror's Governing Documents and (2) any other applicable Contracts governing the issuance of such securities; and (iii) are not subject to, nor have they been issued in violation of, any purchase option, call option, right of first refusal, preemptive right, subscription right or any similar right under any provision of any applicable Law, Acquiror's Governing Documents or any Contract to which Acquiror is a party or otherwise bound.

(c) Except as set forth in the Sponsor Support Agreement, this Agreement and in Acquiror's Governing Documents, there are no outstanding Contracts of Acquiror to repurchase, redeem or otherwise acquire any Acquiror Securities.

(d) Except as set forth in this Section 5.12 or as contemplated by this Agreement or the other documents contemplated hereby, and other than in connection with the Sponsor Support Agreement, the Working Capital Loans, the Warrant Agreement, and the Acquiror's Governing Documents, Acquiror has not granted any outstanding options, stock appreciation rights, warrants, rights or other securities convertible into or exchangeable or exercisable for Acquiror Securities, or any other commitments or agreements providing for the issuance of additional shares, the sale of treasury shares, for the repurchase or redemption of any Acquiror Securities or the value of which is determined by reference to the Acquiror Securities, and there are no Contracts of any kind which may obligate Acquiror to issue, purchase, redeem or otherwise acquire any of its Acquiror Securities.

(e) The Aggregate Closing Date Merger Consideration and the Acquiror Common Stock, when issued in accordance with the terms hereof, shall be duly authorized and validly issued, fully paid and non-assessable and issued in compliance with all applicable state and federal securities Laws and not subject to, and not issued in violation of, any Lien, purchase option, call option, right of first refusal, preemptive right, subscription right or any similar right under any provision of applicable Law, Acquiror's Governing Documents, or any Contract to which Acquiror is a party or otherwise bound.

(f) Acquiror has no Subsidiaries apart from Merger Sub, and does not own, directly or indirectly, any equity interests or other interests or investments (whether equity or debt) in any Person, whether incorporated or unincorporated. Acquiror is not party to any Contract that obligates Acquiror to invest money in, loan money to or make any capital contribution to any other Person.

Section 5.13. Brokers' Fees. Except fees described on Section 5.13 of the Acquiror Disclosure Letter (including the amounts owed with respect thereto), no broker, finder, investment banker or other Person is entitled to any brokerage fee, finders' fee, underwriting fee, deferred underwriting fee, commission or other similar payment in connection with the transactions contemplated hereby based upon arrangements made by Acquiror, Merger Sub or any of their respective Affiliates, including the Sponsors.

Section 5.14. Indebtedness. Neither Acquiror nor Merger Sub have, or have any present intention, agreement, arrangement or understanding to enter into or incur, any obligations with respect to or under any Indebtedness, except the Working Capital Loans.

Section 5.15. Sponsor Support Agreement. Acquiror has delivered to the Company a true, correct and complete copy of the Sponsor Support Agreement. The Sponsor Support Agreement is in full force and effect and has not been withdrawn or terminated, or otherwise amended or modified, in any respect, and no withdrawal, termination, amendment or modification is contemplated by Acquiror. The Sponsor Support Agreement is a legal, valid and binding obligation of Acquiror and, to the knowledge of Acquiror, each other party thereto and neither the execution or delivery by any party thereto, nor the performance of any party's obligations under, the Sponsor Support Agreement violates any provision of, or results in the breach of or default under, or require any filing, registration or qualification under, any applicable Law. No event has occurred that, with or without notice, lapse of time or both, would constitute a default or breach on the part of Acquiror under any material term or condition of the Sponsor Support Agreement.

Section 5.16. Related Party Transactions. Except as described in the Acquiror SEC Filings, there are no transactions, Contracts, side letters, arrangements or understandings between Acquiror and/or Merger Sub, on the one hand, and any director, officer, employee, stockholder, warrant holder or Affiliate of Acquiror and/or Merger Sub, on the other hand.

Section 5.17. Taxes.

(a) All material Tax Returns required to be filed by or with respect to Acquiror or Merger Sub have been timely filed (taking into account any applicable extensions), all such Tax Returns (taking into account all amendments thereto) are true, complete and accurate in all material respects, and all material Taxes due and payable (whether or not shown on any Tax Return) by Acquiror or Merger Sub have been paid, other than Taxes being contested in good faith and for which appropriate reserves have been established in accordance with GAAP.

(b) The Acquiror and its Subsidiaries have withheld from amounts owing to any employee, creditor or other Person all material amounts of Taxes required by Law to be withheld, paid over to the proper Governmental Authority in a timely manner all such withheld amounts required to have been so paid over and complied in all material respects with all other applicable withholding and related reporting requirements with respect to such Taxes.

(c) There are no Liens for any material amounts of Taxes (other than Permitted Liens) upon the property or assets of Acquiror or Merger Sub.

(d) No claim, assessment, deficiency or proposed adjustment for any material amount of Tax has been asserted or assessed by any Governmental Authority against Acquiror or Merger Sub that remains unresolved or unpaid except for claims, assessments, deficiencies or proposed adjustments being contested in good faith and for which appropriate reserves have been established in accordance with GAAP.

(e) There is no material Tax audit or other examination of the Acquiror or Merger Sub presently in progress, and there are no waivers, extensions or requests for any waivers or extensions of any statute of limitations currently in effect with respect to any material Taxes of the Acquiror or Merger Sub. Neither the Acquiror nor Merger Sub has made a request for an advance tax ruling, request for technical advice, or similar request that is in progress or pending with any Governmental Authority with respect to any Taxes. No written claim has been made by any Governmental Authority where the Acquiror or Merger Sub does not file Tax Returns that it is or may be subject to taxation in that jurisdiction.

(f) Neither the Acquiror nor Merger Sub is a party to any Tax indemnification or Tax sharing or similar agreement (other than any such agreement solely between the Acquiror and/or Merger Sub and customary commercial Contracts not primarily related to Taxes that were entered into with Persons who are not Affiliates or equity owners of Acquiror).

(g) Neither the Acquiror nor Merger Sub has been a party to any transaction treated by the parties as a distribution of stock qualifying for tax-deferred treatment under Section 355 or Section 361 of the Code since January 1, 2020.

(h) Neither the Acquiror nor Merger Sub (A) is liable for Taxes of any other Person (other than the Acquiror or Merger Sub) under Treasury Regulation Section 1.1502-6 or any similar provision of state, local or foreign Tax Law or as a transferee or successor or by Contract (other than customary commercial Contracts not primarily related to Taxes) or (B) has ever been a member of an affiliated, consolidated, combined or unitary group filing for U.S. federal, state or local income Tax purposes, other than a group the common parent of which was and is the Acquiror.

(i) Neither Acquiror nor Merger Sub has participated in a "listed transaction" within the meaning of Treasury Regulation 1.6011-4(b)(2).

(j) Neither the Acquiror nor Merger Sub will be required to include any material amount in taxable income, exclude any material item of deduction or loss from taxable income, or make any adjustment under Section 481 of the Code (or any similar provision of state, local or foreign Law) for any taxable period (or portion thereof) beginning after the Closing Date as a result of any (i) installment sale, intercompany transaction described in the Treasury Regulations under Section 1502 of the Code (or any similar provision of state, local or foreign Law) or open transaction disposition made on or prior to the Closing Date, (ii) prepaid amount received or deferred revenue recognized prior to the Closing, (iii) change in method of accounting of the Acquiror or Merger Sub for a taxable period (or portion thereof) ending on or prior to the Closing Date made prior to the Closing, (iv) "closing agreement" described in Section 7121 of the Code (or any similar provision of state, local or foreign Law) executed by the Acquiror or Merger Sub prior to the Closing, or (v) election under Section 965(h) of the Code.

(k) Acquiror and Merger Sub have not knowingly taken any action, nor, to the knowledge of Acquiror, are there any facts or circumstances, that would reasonably be expected to prevent the Merger from qualifying for the Intended Tax Treatment.

(l) Neither Acquiror nor Merger Sub has been a "United States real property holding corporation" within the meaning of Section 897(c)(2) of the Code during the applicable period specified in Section 897(c)(1)(A)(ii) of the Code.

(m) Acquiror has not ever owned any equity interest in another Person (other than Merger Sub). Merger Sub was newly formed solely to effect the Merger and it will not conduct any business activities or other operations of any kind (other than administrative or ministerial activities) prior to the Merger.

(n) Acquiror has not received written notice from a non-U.S. Tax authority that it has a permanent establishment (within the meaning of an applicable Tax treaty) or otherwise has an office or fixed place of business in a country, in each case, other than the country in which it is organized.

(o) For U.S. federal income tax purposes, Acquiror is, and has been since the date of Acquiror's formation, classified as a corporation.

Section 5.18. Business Activities.

(a) Since formation, neither Acquiror or Merger Sub have conducted any business activities other than activities related to Acquiror's initial public offering or directed toward the accomplishment of a Business Combination. Except as set forth in Acquiror's Governing Documents or as otherwise contemplated by this Agreement or the Ancillary Agreements and the transactions contemplated hereby and thereby, there is no agreement, commitment, or Governmental Order binding upon Acquiror or Merger Sub or to which Acquiror or Merger Sub is a party which has or would reasonably be expected to have the effect of prohibiting or impairing any business practice of Acquiror or Merger Sub or any acquisition of property by Acquiror or Merger Sub or the conduct of business by Acquiror or Merger Sub as currently conducted or as contemplated to be conducted as of the Closing, other than such effects, individually or in the aggregate, which have not been and would not reasonably be expected to be material to Acquiror or Merger Sub.

(b) Except for Merger Sub and the transactions contemplated by this Agreement and the Ancillary Agreements, Acquiror does not own or have a right to acquire, directly or indirectly, any interest or investment (whether equity or debt) in any corporation, partnership, joint venture, business, trust or other entity. Except for this Agreement and the Ancillary Agreements and the transactions contemplated hereby and thereby, Acquiror has no material interests, rights, obligations or liabilities with respect to, and is not party to, bound by or has its assets or property subject to, in each case whether directly or indirectly, any Contract or transaction which is, or would reasonably be interpreted as constituting, a Business Combination. Except for the transactions contemplated by this Agreement and the Ancillary Agreements, Merger Sub does not own or have a right to acquire, directly or indirectly, any interest or investment (whether equity or debt) in any corporation, partnership, joint venture, business, trust or other entity.

(c) Merger Sub was formed solely for the purpose of effecting the transactions contemplated by this Agreement and has not engaged in any business activities or conducted any operations other than in connection with the transactions contemplated hereby and has no, and at all times prior to the Effective Time, except as expressly contemplated by this Agreement, the Ancillary Agreements and the other documents and transactions contemplated hereby and thereby, will have no, assets, liabilities or obligations of any kind or nature whatsoever other than those incident to its formation.

(d) As of the date hereof and except for this Agreement, the Ancillary Agreements and the other documents and transactions contemplated hereby and thereby (including with respect to expenses and fees incurred in connection therewith), neither Acquiror nor Merger Sub are party to any Contract with any other Person that would require payments by Acquiror or any of its Subsidiaries after the date hereof in excess of \$50,000 in the aggregate with respect to any individual Contract, other than Working Capital Loans, except as disclosed in any Acquiror SEC Filings or as set forth on Section 5.18(d) of the Acquiror Disclosure Letter.

(e) Other than any former officers or as described in the Acquiror SEC Filings, neither Acquiror nor Merger Sub have ever had any employees. Other than reimbursement of any out-of-pocket expenses incurred by Acquiror's officers and directors in connection with activities on Acquiror's behalf in an aggregate amount not in excess of the amount of cash held by Acquiror outside of the Trust Account, Acquiror has no unsatisfied material liability with respect to any employee. Acquiror does not currently maintain or have any direct liability under any benefit plan, and neither the execution and delivery of this Agreement or the Ancillary Agreement nor the consummation of the transactions contemplated hereby and thereby will: (a) result in any payment (including severance, unemployment compensation, golden parachute, bonus or otherwise) becoming due to any director, officer, individual independent contractor or employee of Acquiror; or (b) result in the acceleration of the time of payment or vesting of any compensation or benefits.

Section 5.19. Nasdaq Stock Market Quotation. The issued and outstanding Acquiror Units are registered pursuant to Section 12(b) of the Exchange Act and are listed for trading on the Nasdaq under the symbol "ROCGU." The issued and outstanding shares Acquiror Common Stock are registered pursuant to Section 12(b) of the Exchange Act and are listed for trading on the Nasdaq under the symbol "ROCG". The issued and outstanding Acquiror Warrants are registered pursuant to Section 12(b) of the Exchange Act and are listed for trading on the Nasdaq under the symbol "ROCGW". As of the date of this Agreement, there is no Action or proceeding pending or, to the knowledge of Acquiror, threatened against Acquiror by the Nasdaq or the SEC with respect to any intention by such entity to deregister the Acquiror Units, the Acquiror Common Stock, or the Acquiror Warrants or terminate the listing of the Acquiror Units, the Acquiror Common Stock, or the Acquiror Warrants on the Nasdaq. None of Acquiror, Merger Sub or their respective Affiliates has taken any action in an attempt to terminate the registration of the Acquiror Units, the Acquiror Common Stock or the Acquiror Warrants under the Exchange Act except as contemplated by this Agreement.

Section 5.20. Registration Statement and Proxy Statement. None of the information relating to the Acquiror or its Subsidiaries supplied or to be supplied by the Acquiror or any of the Acquiror's Subsidiaries in writing specifically for inclusion in the Registration Statement (including the Proxy Statement and Prospectus included therein) will, (a) when the Registration Statement is first filed, (b) on the effective date of the Registration Statement, (c) on the date when the Proxy Statement is mailed to the Acquiror's Voting Stockholders and (d) at the time of the Acquiror's Stockholders' Meeting, contain any untrue statement of a material fact or omit to state any material fact required to be stated therein or necessary in order to make the statements therein, in light of the circumstances under which they are made, not misleading.

Section 5.21. No Outside Reliance. Notwithstanding anything contained in this Article V or any other provision hereof, each of Acquiror and Merger Sub, and any of their respective directors, managers, officers, employees, equityholders, partners, members or representatives, acknowledge and agree that Acquiror has made its own investigation of the Company and that neither the Company nor any of its Affiliates, agents or representatives is making any representation or warranty whatsoever, express or implied, beyond those expressly given by the Company in Article IV, including any implied warranty or representation as to condition, merchantability, suitability or fitness for a particular purpose or trade as to any of the assets of the Company or its Subsidiaries. Without limiting the generality of the foregoing, it is understood that any cost estimates, financial or other projections or other predictions that may be contained or referred to in the Company Disclosure Letter or elsewhere, as well as any information, documents or other materials (including any such materials contained in any "data room" (whether or not accessed by Acquiror or its representatives) or reviewed by Acquiror pursuant to the Confidentiality Agreement) or management presentations that have been or shall hereafter be provided to Acquiror or any of its Affiliates, agents or representatives are not and will not be deemed to be representations or warranties of the Company, and no representation or warranty is made as to the accuracy or completeness of any of the foregoing except as may be expressly set forth in Article IV of this Agreement. Except as otherwise expressly set forth in this Agreement, Acquiror understands and agrees that any assets, properties and business of the Company and its Subsidiaries are furnished "as is", "where is" and subject to and except as otherwise provided in the representations and warranties contained in Article IV, with all faults and without any other representation or warranty of any nature whatsoever.

Section 5.22. No Additional Representation or Warranties. The Acquiror and Merger Sub acknowledge and agree that, except as provided in Article IV, neither the Company nor any of its Affiliates, nor any of its or their respective directors, managers, officers, employees, equityholders, partners, members or representatives has made, or is making, any representation or warranty whatsoever to the Acquiror, Merger Sub or any of their respective Affiliates and no such party shall be liable in respect of the accuracy or completeness of any information provided to the Acquiror, Merger Sub or any of their respective Affiliates. Without limiting the foregoing, the Acquiror and Merger Sub acknowledge that the Acquiror, Merger Sub and their respective advisors, have made their own investigation of the Company and its Subsidiaries and, except as provided in Article IV, are not relying on any representation or warranty whatsoever as to the condition, merchantability, suitability or fitness for a particular purpose or trade as to any of the assets of the Company or any of its Subsidiaries, the prospects (financial or otherwise) or the viability or likelihood of success of the business of the Company and its Subsidiaries as conducted after the Closing, as contained in any materials provided by the Company or any of its Affiliates or any of their respective directors, officers, employees, stockholders, partners, members or representatives or otherwise.

ARTICLE VI

COVENANTS OF THE COMPANY

Section 6.1. Conduct of Business. From the date of this Agreement until the earlier of the Closing or the termination of this Agreement pursuant to Article X (the "Interim Period"), the Company shall, and shall cause its Subsidiaries to, except (i) as otherwise expressly contemplated by this Agreement or the Ancillary Agreements, (ii) as set forth on Section 6.1 of the Company Disclosure Letter, required by Law or any COVID-19 Measures, (iii) in connection with any Capital Raising Transaction, or (iv) as consented to by Acquiror (which consent shall not be unreasonably conditioned, withheld, delayed or denied), use its commercially reasonable efforts to operate the business of the Company in the ordinary course of business consistent with past practice (including, for the avoidance of doubt, recent past practice in light of COVID-19; *provided, that* any action taken, or omitted to be taken, that relates to, or arises out of, COVID-19 shall be deemed to be in the ordinary course of business). Notwithstanding anything to the contrary contained herein, nothing herein shall prevent the Company or any of its Subsidiaries from taking or failing to take any action, including the establishment of any policy, procedure or protocol, in response to COVID-19 or any COVID-19 Measures and (x) no such actions or failure to take such actions shall be deemed to violate or breach this Agreement in any way, (y) all such actions or failure to take such actions shall be deemed to constitute an action taken in the ordinary course of business and (z) no such actions or failure to take such actions shall serve as a basis for Acquiror to terminate this Agreement or assert that any of the conditions to the Closing contained herein have not been satisfied. Without limiting the generality of the foregoing, except as (A) contemplated by this Agreement (including in connection with any Capital Raising Transaction), (B) set forth on Section 6.1 of the Company Disclosure Letter or (C) consented to by Acquiror in writing (which consent shall not be unreasonably conditioned, withheld, delayed or denied) the Company shall not, and the Company shall cause its Subsidiaries not to, during the Interim Period, except as otherwise contemplated by this Agreement or the Ancillary Agreements or required by Law:

- (a) change or amend the Governing Documents of the Company in a manner that would increase the Aggregate Closing Date Merger Consideration payable to the stockholders of the Company;
- (b) make or declare any dividend or distribution to the stockholders of the Company or make any other distributions in respect of any of the Company Capital Stock or equity interests, other than any dividends or distributions from any wholly owned Subsidiary of the Company to the Company or any other wholly owned Subsidiary of the Company;
- (c) split, combine, reclassify, recapitalize, subdivide or redeem, or purchase or otherwise acquire, directly or indirectly, any of its capital stock, other than redemptions of equity securities from former employees upon the terms set forth in the underlying agreements governing such equity securities or otherwise amend any terms of any shares or series of the Company Capital Stock or equity interests in a manner that would increase the Aggregate Closing Date Merger Consideration payable to the stockholders of the Company;

(d) reclassify, combine, split, subdivide or redeem, purchase or otherwise acquire, directly or indirectly, any issued and outstanding share capital, outstanding shares of capital stock, membership interests or other equity interests of the Company or its Subsidiaries, except for (i) the acquisition by the Company of any shares of capital stock, membership interests or other equity interests of the Company or its Subsidiaries or of any Company Options in connection with the forfeiture or cancellation of such interests or Company Options upon the terms set forth in the underlying agreements governing such equity securities, (ii) the acquisition by the Company of shares of Company Common Stock in connection with the surrender of shares of Company Common Stock by holders of Company Options in order to pay the exercise price of the Company Options, (iii) the withholding of shares of Company Common Stock to satisfy Tax obligations with respect to the Company Options or Company Warrants, and (iv) any redemption or purchase of any equity interests of the Company or its Subsidiaries, whether in a single transaction or a series of transaction, with an aggregate value not to exceed \$1,000,000;

(e) enter into, modify in any material respect or terminate (other than any expiration in accordance with its terms) any Contract of a type required to be listed in Section 4.12(a) of the Company Disclosure Letter, or any Real Property Lease, in each case, other than in the ordinary course of business or as required by Law (including, for the sake of clarity, supply agreements, distribution agreements and partnership agreements);

(f) sell, assign, transfer, convey, lease, grant or encumber, or otherwise dispose of or authorize the sale, assignment, transfer, conveyance, lease, grant or encumbrance of (A) any material tangible assets or properties of the Company and its Subsidiaries, taken as a whole, except for (i) the sale of inventory, goods or services in the ordinary course of business, (ii) the sale or other disposition of assets or equipment deemed by the Company in its reasonable business judgement to be obsolete or no longer be material to the business of the Company and its Subsidiaries, or (iii) transactions in the ordinary course of business, or (B) any shares of any class of capital stock of, or any equity interests in, the Company or any Subsidiary of the Company, or any options, warrants, restricted share units, convertible securities or other rights of any kind to acquire any shares of such capital stock, or any other ownership interest (including any phantom interest), of the Company or any Subsidiary of the Company, except for (i) increases to share capital of Subsidiaries of the Company in the ordinary course of business, (ii) the exercise or settlement of any Company Options in the ordinary course of business, or (iii) the grant of Company Options pursuant to the Company Incentive Plans, with an exercise price that is intended to be no less than the fair market value of the underlying Company Common Stock on the date of grant, as determined in accordance with Section 409A of the Code or Section 422 of the Code, if applicable, in substantially the forms previously made available to Acquiror, with no materially different terms from those set forth in such forms, including a thirty-six (36) month vesting period with a one (1) year cliff and annual partial vesting thereafter;

(g) except as set forth on Section 6.1(g) of the Company Disclosure Letter, acquire by merger or consolidation with, or merge or consolidate with, or purchase substantially all or a substantial portion of the assets of, any corporation, partnership, association, joint venture or other business organization or division thereof if such acquisition, merger, or consolidation would require such entity's financial statements to be included in the Registration Statement pursuant to Rule 3-05 of Regulation S-X under the Securities Act;

(h) acquire any equity interest or other interest in any other entity or enter into a joint venture or business association with any other entity that would require such entity's financial statements to be included in the Registration Statement pursuant to Rule 3-05 of Regulation S-X under the Securities Act;

(i) incur or assume any Indebtedness for borrowed money, except (1) as set forth on Section 6.1(i) of the Company Disclosure Letter, (2) as incurred between the Company and any of its wholly-owned Subsidiaries or between any of such wholly-owned Subsidiaries, or (3) otherwise in an aggregate amount not to exceed \$1,000,000;

(j) (i) make or change any material election in respect of material Taxes, (ii) materially amend, modify or otherwise change any filed material Tax Return, (iii) adopt or request permission of any taxing authority to change any accounting method in respect of material Taxes, (iv) enter into any material closing agreement in respect of material Taxes executed on or prior to the Closing Date, (v) settle any claim or assessment in respect of material Tax liabilities, (vi) surrender any right to claim a material refund of Taxes or (vii) consent to any extension or waiver of the limitation period applicable to any material Tax claim or assessment (other than any extension pursuant to an extension to file any Tax Return);

(k) knowingly take any action, or knowingly fail to take any action, where such action or failure to act would reasonably be expected to cause the Merger to fail to qualify for the Intended Tax Treatment;

(l) adopt or enter into a plan of complete or partial liquidation, dissolution, restructuring, recapitalization or other reorganization of the Company or its Subsidiaries (other than the transactions contemplated by this Agreement, including the Merger);

(m) settle any pending or threatened Action, (i) if such settlement would require payment by the Company in an amount greater than \$2,000,000 individually or in the aggregate together with any other settlement of any pending or threatened Action, (ii) to the extent such settlement includes an agreement to accept or concede injunctive relief or (iii) to the extent such settlement involves a Governmental Authority or alleged criminal wrongdoing;

(n) enter into or extend any collective bargaining agreement or similar labor agreement to which the Company or its Subsidiaries is a party or by which it is bound, other than entry into such agreement in the ordinary course of business or as required by applicable Law;

(o) terminate without replacement or amend in a manner materially detrimental to the Company and its Subsidiaries, taken as a whole, any material insurance policy insuring the business of the Company or any of the Company's Subsidiaries;

(p) except as set forth on Section 6.1(p) of the Company Disclosure Letter or except as required under applicable Law or the terms of any Company Benefit Plan as in effect on the date hereof (A) grant any material increase in the compensation, incentives or benefits (including severance) payable or to become payable to any current or former director, officer, employee or consultant of the Company or any Subsidiary of the Company, other than market performance-based increases to salary or cash incentives in the ordinary course of business consistent with past practice, (B) enter into any new, or materially amend any existing, employment, retention, bonus, change in control, or severance agreement with any such individual, (C) accelerate the funding, payment, or vesting of any compensation or benefits, (D) establish or become obligated under any collective bargaining agreement or other contract or agreement with a labor union, trade union, works council, or other representative of employees;

(q) hire any employee or retain the independent contractor services of any individual whose individual base cash compensation is expected to exceed \$400,000 per annum;

(r) except as set forth on Section 6.1(f) of the Company Disclosure Letter, hire or otherwise retain the services of any individual as an officer or executive of the Company or any of its Subsidiaries, who (i) reports directly to the Chief Executive Officer (or any individual senior to the Chief Executive Officer) of the Company, or (ii) is an individual who will become subject to the reporting requirements of Section 16(a) of the Exchange Act after the Closing,;

(s) except as required by applicable Law or as otherwise permitted by Section 6.1(p) or the terms of this Agreement, adopt, materially amend, or terminate any Company Benefit Plan in effect as of the date hereof or any employee benefit plan, program, agreement or arrangement that would be a Company Benefit Plan if in effect on the date hereof;

(t) materially amend or change any accounting policies or procedures of the Company or any Subsidiary of the Company, other than reasonable and usual amendments in the ordinary course of business, or as may be required by a change in GAAP (including pursuant to standards, guidelines and interpretations of the Financial Accounting Standards Board or any similar organization) or applicable Law;

(u) intentionally permit any material item of Intellectual Property owned by the Company or any of its Subsidiaries to lapse or to be abandoned, invalidated, dedicated to the public, or disclaimed, or otherwise become unenforceable, other than (i) the expiration of any such Intellectual Property in accordance with the applicable statutory term or abandonment of Intellectual Property registrations or applications in the ordinary course of business or (ii) as deemed by the Company or any of its Subsidiaries in their business judgment to be obsolete or not worth the costs of maintaining or registering; or

(v) enter into any formal or informal agreement or otherwise make a binding commitment to do any action prohibited under this Section 6.1.

Nothing herein shall require the Company to obtain consent from the Acquiror to do any of the foregoing if obtaining such consent might reasonably be expected to violate applicable Law, and except as expressly set out above in this Section 6.1, nothing in this Section 6.1 is intended to give to the Acquiror, directly or indirectly, the right to control or direct the ordinary course of business operations of the Company prior to the Closing Date. Prior to the Closing Date, the Company shall exercise, consistent with the terms and conditions hereof, complete control and supervision of its operations as required by Law.

Section 6.2. Inspection. Subject to confidentiality obligations that may be applicable to information furnished to the Company or any of the Company's Subsidiaries by third parties that may be in the Company's or any of its Subsidiaries' possession from time to time, and except for any information that is subject to attorney-client privilege (*provided, that* to the extent possible, the parties shall cooperate in good faith to permit disclosure of such information in a manner that preserves such privilege or compliance with such confidentiality obligation), and to the extent permitted by applicable Law, the Company shall, and shall cause its Subsidiaries to, afford to Acquiror and its accountants, counsel, consultants, and other representatives reasonable access during the Interim Period (including for the purpose of coordinating transition planning for employees), during normal business hours and with reasonable advance notice, to all of their respective properties, books, Contracts, commitments, Tax Returns, records and appropriate officers and employees of the Company and its Subsidiaries, and shall furnish such representatives with all financial and operating data and other information concerning the affairs of the Company and its Subsidiaries as such representatives may reasonably request; *provided, that* the Company shall, and shall cause its Subsidiaries to, provide to Acquiror and, if applicable, its accountants, counsel or other representatives, (a) such information and such other materials and resources relating to any Action initiated, pending or threatened during the Interim Period, or to the compliance and risk management operations and activities of the Company and its Subsidiaries during the Interim Period, in each case, as Acquiror or such representative may reasonably request, (b) prompt written notice of any material status updates in connection with any such Actions or otherwise relating to any compliance and risk management matters or decisions of the Company or its Subsidiaries, and (c) copies of any communications sent or received by the Company or its Subsidiaries in connection with such Actions, matters and decisions (and, if any such communications occurred orally, the Company shall, and shall cause its Subsidiaries to, memorialize such communications in writing to Acquiror). All information obtained by Acquiror, Merger Sub or their respective representatives pursuant to this Section 6.2 shall be subject to the Confidentiality Agreement.

Section 6.3. Preparation and Delivery of Updated Interim Financial Statements.

(a) (i) As soon as reasonably practicable after the date of this Agreement, the Company shall deliver to Acquiror the unaudited consolidated balance sheets and statements of operations, comprehensive loss, stockholders' equity, and cash flows, prepared in accordance with GAAP, of the Company and its Subsidiaries as of and for the nine (9)-month period ending September 30, 2022 (the "Q3 Financial Statements"), (ii) if the Registration Statement has not been declared effective prior to March 31, 2023, as soon as reasonably practicable following March 31, 2023, the Company shall deliver to Acquiror the unaudited consolidated balance sheets and statements of operations, comprehensive loss, stockholders' equity, and cash flows, prepared in accordance with GAAP, of the Company and its Subsidiaries as of and for the twelve (12)-month period ending December 31, 2022 (the "Q4 Financial Statements"), and (iii) if the Registration Statement has not been declared effective by May 15, 2023, as soon as reasonably practicable following May 15, 2023, the Company shall deliver to Acquiror the unaudited consolidated balance sheets and statements of operations, comprehensive loss, stockholders' equity, and cash flows, prepared in accordance with GAAP, of the Company and its Subsidiaries as of and for the three (3)-month period ending March 31, 2023 (the "Q1'23 Financial Statements"), and together (as applicable) with the Q4 Financial Statements and the Q3 Financial Statements, the "Updated Interim Financial Statements", which comply with the applicable accounting requirements and with the rules and regulations of the SEC, the Exchange Act and the Securities Act applicable to a registrant; *provided, that* upon delivery of such Updated Interim Financial Statements, the representations and warranties set forth in Section 4.8 shall be deemed to apply to the Updated Interim Financial Statements, *mutatis mutandis*, with the same force and effect as if made as of the date of this Agreement.

(b) After the date of this Agreement and until the Closing, solely if and to the extent prepared by the Company, the Company shall deliver to Acquiror unaudited consolidated balance sheets and statements of operations, comprehensive loss, stockholders' equity, and cash flows of the Company and its Subsidiaries, all prepared in accordance with GAAP, for each calendar month ending after the date of this Agreement as soon as reasonably practicable.

Section 6.4. Acquiror Extension Expenses.

(a) From time to time, the Sponsor may provide an advance written request to the Company for disbursement of funds to pay Acquiror Extension Expenses (with supporting documentation attached thereto). Within five (5) days after such request and upon reasonable review and approval by the Company, the Company shall disburse the requested funds to the Sponsors to pay Acquiror Extension Expenses, by wire transfer of immediately available funds to an account or accounts designated in writing by the Sponsors (all such disbursements, collectively, the "Sponsor Advances"); *provided*, that the total amount of Sponsor Advances shall not exceed \$500,000.00 and shall be subject to repayment or acceleration as contemplated under the Note Agreement.

(b) Notwithstanding anything to the contrary contained herein, including Section 10.1 and Section 10.2, the provisions of Section 6.4 shall survive any termination of this Agreement.

Section 6.5. Termination of Certain Agreements. On and as of the Closing, the Company shall take actions reasonably necessary to cause the Contracts listed on Section 6.5 of the Company Disclosure Letter to be terminated or settled without further liability to the Company or any of the Company's Subsidiaries (as applicable), in each case, except as otherwise set forth on Section 6.5 of the Company Disclosure Letter.

Section 6.6. Acquisition Proposals. From the date hereof until the Closing Date or, if earlier, the termination of this Agreement in accordance with Article X, except as set forth on Section 6.1(g) of the Company Disclosure Letter, the Company and its Subsidiaries shall not, and the Company and its Subsidiaries shall direct its and their representatives, not to (i) knowingly solicit or initiate any inquiries, indications of interest, proposal or offer by any third party with respect to an Acquisition Proposal; (ii) furnish or make available to any third party information in respect of, or access to, the business, properties, assets or personnel of the Company or any of the Company's Subsidiaries in connection with an Acquisition Proposal, or (iii) enter into any acquisition agreement, merger agreement or similar definitive agreement, or any letter of intent, memorandum of understanding or agreement in principle, or any other agreement relating to an Acquisition Proposal. The Company shall, and shall cause its Subsidiaries and instruct and use reasonable best efforts to instruct its and their respective affiliates and Representatives to, immediately cease any and all existing discussions or negotiations with any person conducted heretofore with respect to any Acquisition Proposal. The Company also agrees that it will promptly request each Person (other than the parties hereto and their respective Representatives) that has prior to the date hereof executed a confidentiality agreement in connection with its, his or her consideration of acquiring the Company to return or destroy all confidential information furnished to such Person by or on behalf of it, him, or her prior to the date hereof, except such confidential information that may be stored on backup drives as part of its, his or her standard archiving process. If the Company or any of its Representatives receives any inquiry or proposal with respect to an Acquisition Proposal at any time prior to the Closing, then the Company shall promptly notify such Person in writing that the Company is subject to an exclusivity agreement with respect to the sale of the Company that prohibits it from considering such inquiry or proposal, and will provide Acquiror with a copy of any such written inquiry or proposal or a reasonably detailed summary of any such verbal inquiry or proposal, including in each case the identity of the Person making such inquiry or proposal. Without limiting the foregoing, the parties agree that any violation of the restrictions set forth in this Section 6.6 by a party or any of its Subsidiaries or its or their respective affiliates or Representatives, in each case, at the express direction of such party shall be deemed to be a breach of this Section 6.6 by such party.

Section 6.7. Company Employee Matters. Prior to the Closing Date, the Company shall negotiate employment agreements (including related severance provisions) in good faith with each of the employees of the Company listed in Section 6.1(n) of the Company Disclosure Letter, which effective date of such employment agreements (including related severance provisions) shall be contingent upon, and effective as of, the Closing.

ARTICLE VII

COVENANTS OF ACQUIROR

Section 7.1. Acquiror Employee Matters.

(a) Equity Plan. Prior to the Closing Date, Acquiror shall approve and adopt an incentive equity plan (the "Incentive Equity Plan"), effective as of one Business Day prior to the Closing Date, as proposed by the Board of Directors of the Company based on the advice of an independent compensation consultant and subject to reasonable review and approval by the Acquiror, such approval not to be unreasonably withheld. The Incentive Equity Plan shall have an initial share reserve ranging not to exceed ten percent (10%) of the fully-diluted Acquiror Common Stock immediately following the Closing, plus an annual "evergreen" increase, which, in each case, shall be based upon benchmarking against peer companies in consultation with an independent compensation consultant.

(b) No Third-Party Beneficiaries. Notwithstanding anything herein to the contrary, each of the parties to this Agreement acknowledges and agrees that all provisions contained in this Section 7.1 are included for the sole benefit of Acquiror and the Company, and that nothing in this Agreement, whether express or implied, (i) shall be construed to establish, amend, or modify any employee benefit plan, program, agreement or arrangement, (ii) shall limit the right of Acquiror, the Company or their respective Affiliates to amend, terminate or otherwise modify any Company Benefit Plan or other employee benefit plan, agreement or other arrangement following the Closing Date, or (iii) shall confer upon any Person who is not a party to this Agreement (including any equityholder, any current or former director, manager, officer, employee or independent contractor of the Company, or any participant in any Company Benefit Plan or other employee benefit plan, agreement or other arrangement (or any dependent or beneficiary thereof)), any right to continued or resumed employment or recall, any right to compensation or benefits, or any third-party beneficiary or other right of any kind or nature whatsoever.

Section 7.2. Trust Account Proceeds and Related Available Equity. Upon satisfaction or waiver of the conditions set forth in Article IX and provision of notice thereof to the Trustee (which notice Acquiror shall provide to the Trustee in accordance with the terms of the Trust Agreement), (i) in accordance with and pursuant to the Trust Agreement, at the Closing, Acquiror (a) shall cause any documents, opinions and notices required to be delivered to the Trustee pursuant to the Trust Agreement to be so delivered and (b) shall use its commercially reasonable efforts to cause the Trustee to, and the Trustee shall thereupon be obligated to (1) pay as and when due all amounts payable to Acquiror Stockholders pursuant to the Acquiror Share Redemptions, (2) pay the Unpaid Transaction Expenses in accordance with Section 2.5(c), and (3) pay all remaining amounts, less the fees and costs incurred by the Trustee in accordance with the Trust Agreement, then available in the Trust Account to Acquiror for immediate use, subject to this Agreement and the Trust Agreement, and (ii) thereafter, the Trust Account shall terminate, except as otherwise provided therein.

Section 7.3. Nasdaq Listing. From the date hereof through the Effective Time, Acquiror shall use reasonable best efforts to ensure Acquiror remains listed as a public company on the Nasdaq. As promptly as practicable following the date hereof, Acquiror shall prepare and submit to Nasdaq a listing application ("Listing Application") (subject to the Company's prior review and approval, which shall not be unreasonably withheld, conditioned, or delayed), covering the continued listing of Acquiror Common Stock and Acquiror Warrants and use its reasonable best efforts to obtain approval for the continued listing of the Acquiror Common Stock and Acquiror Warrants, and the Company shall reasonably cooperate with Acquiror with respect to such listing and to do such things as are necessary, proper and advisable which may be requested by Nasdaq in connection with such listing. Acquiror shall not submit the Listing Application or any supplement or amendment thereto, or respond to comments received from Nasdaq with respect thereto, without providing the Company a reasonable opportunity to review and comment thereon. Acquiror shall promptly notify the Company upon the receipt of any comments from Nasdaq, or any request from Nasdaq for amendments or supplements to the Listing Application and shall provide the Company with copies of all material correspondence between Acquiror or any of its Representatives, on the one hand, and Nasdaq, on the other hand, and all written comments with respect to the Listing Application received from Nasdaq, and advise the Company of any oral comments with respect to the Listing Application received from Nasdaq. Promptly after receiving notice thereof, Acquiror shall advise the Company of the time of the approval of the Listing Application and the approval for listing on the Nasdaq of the Acquiror Common Stock and Acquiror Warrants.

Section 7.4. No Solicitation by Acquiror. From the date hereof until the Closing Date or, if earlier, the termination of this Agreement in accordance with Article X, Acquiror shall not, and shall cause its Subsidiaries not to, and Acquiror shall direct its and their representatives, not to, (i) make any proposal or offer that constitutes a Business Combination Proposal, (ii) solicit or initiate any inquiry, indication or interest, proposal or offer or participate in any discussions or negotiations with any Person, or furnish or make available to such Person any information with respect to, a Business Combination Proposal (other than to make such Person aware of the provisions of this Section 7.4) or (iii) enter into any understanding, arrangement, acquisition agreement, business combination, merger agreement or similar definitive agreement, or any letter of intent, memorandum of understanding or agreement in principle, or any other commitment (whether or not legally binding) with any third party relating to a Business Combination Proposal, in each case, other than to or with the Company and its respective representatives. From and after the date hereof, Acquiror shall, and shall direct its officers and directors to, and Acquiror shall instruct and cause its representatives, its Subsidiaries and their respective representatives to, immediately cease and terminate all discussions and negotiations with any Persons that may be ongoing with respect to a Business Combination Proposal (other than the Company and its representatives); *provided, however*, that a party will not be required to inform the other party of the identity of the person or entity making such proposal.

Section 7.5. Acquiror Conduct of Business.

(a) During the Interim Period, Acquiror shall, and shall cause Merger Sub to, except as contemplated by this Agreement or the Ancillary Agreements, as required by Law (including as may be requested or compelled by any Governmental Authority), set forth on Section 7.5 of the Acquiror Disclosure Letter, or as consented to by the Company in writing (which consent shall not be unreasonably conditioned, withheld, delayed or denied), use its commercially reasonable efforts to operate its business in the ordinary course and consistent with past practice. Without limiting the generality of the foregoing, except as contemplated by this Agreement, set forth on Section 7.5 of the Acquiror Disclosure Letter, or consented to by the Company in writing (which consent shall not be unreasonably conditioned, withheld, delayed or denied), Acquiror shall not, and Acquiror shall cause Merger Sub not to, except as otherwise contemplated by this Agreement or the Ancillary Agreements or as required by Law:

(i) seek any approval from the holders of shares of Acquiror Common Stock, to change, modify or amend the Trust Agreement, the Acquiror Warrants, the Warrant Agreement or the Governing Documents of Acquiror or Merger Sub, except as contemplated by the Transaction Proposals;

(ii) (x) make, pay, set aside, or declare any dividend or distribution to the stockholders of Acquiror or make any other distributions in respect of any of Acquiror's or Merger Sub Capital Stock, share capital or equity interests, (y) split, combine, reclassify or otherwise amend or modify any terms of any shares or series of Acquiror's or Merger Sub Capital Stock or equity interests, or (z) purchase, repurchase, redeem or otherwise acquire (or offer to purchase, repurchase, redeem or otherwise acquire) any issued and outstanding share capital, outstanding shares of capital stock, share capital or membership interests, warrants or other equity interests of Acquiror or Merger Sub, other than a redemption of shares of Acquiror Common Stock made as part of the Acquiror Share Redemptions;

(iii) (A) make or change any material election in respect of Taxes, (B) amend, modify or otherwise change any filed material Tax Return, (C) adopt or request permission of any taxing authority to change any accounting method in respect of material Taxes, (D) enter into any closing agreement in respect of material Taxes or enter into any Tax sharing or similar agreement, (E) settle any claim or assessment in respect of material Taxes, (F) surrender or allow to expire any right to claim a refund of material Taxes; or (G) consent to any extension or waiver of the limitation period applicable to any claim or assessment in respect of material Taxes;

(iv) knowingly take any action, or knowingly fail to take any action, where such action or failure to act would reasonably be expected to cause the Merger to fail to qualify for the Intended Tax Treatment;

(v) other than as expressly required by the Sponsor Support Agreement, enter into, renew, terminate, amend, restate, supplement or otherwise modify or waive any provision of any transaction or Contract with an Affiliate of Acquiror or Merger Sub (including, for the avoidance of doubt, (x) the Sponsors and (y) any Person in which any of the Sponsors has a direct or indirect legal, contractual or beneficial ownership interest of five percent (5%) or greater);

(vi) incur, assume, guarantee or otherwise become liable for (whether directly, contingently or otherwise) any Indebtedness, otherwise knowingly and purposefully incur, guarantee or otherwise become liable for (whether directly, contingently or otherwise) any other material liabilities, debts or obligations, or issue or sell any debt securities or warrants or other rights to acquire any debt securities of the Company or any of the Company's Subsidiaries or guaranty any debt securities of another Person, other than any indebtedness for borrowed money or guarantee (w) incurred in the ordinary course of business consistent with past practice and in an aggregate amount not to exceed \$100,000, (x) incurred between Acquiror and Merger Sub, (y) fees and expenses for professional services incurred in support of the transactions contemplated by this Agreement and the Ancillary Agreements or in support of the ordinary course operations of Acquiror, and (z) any Working Capital Loan incurred in the ordinary course of business in order to finance transaction costs in connection with a Business Combination and/or ordinary course working capital needs of Acquiror that occur after the date of this Agreement;

(vii) (A) issue any Acquiror Securities or securities exercisable for or convertible into Acquiror Securities, other than the issuance of the Aggregate Closing Date Merger Consideration, (B) grant any options, warrants or other equity-based awards with respect to Acquiror Securities not outstanding on the date hereof, or (C) amend, modify or waive any of the material terms or rights set forth in any Acquiror Warrant or the Warrant Agreement, including any amendment, modification or reduction of the warrant price set forth therein (other than as set forth in the proviso of set forth in the first sentence of Section 5.12(b) of this Agreement);

(viii) fail to use best efforts to maintain the listing of the Acquiror Units, the Acquiror Common Stock, and the Acquiror Warrants on the Nasdaq;

(ix) incorporate, form or organize any new direct or indirect Subsidiary of Acquiror or engage in any new line of business that is materially different from the general nature of the businesses of the Acquiror or Merger Sub as of the date hereof;

(x) enter into, modify or amend in any material respect or terminate (other than by expiration in accordance with the terms of any Contract without an auto-renewal or similar term) any material Contract, in each case, other than in the ordinary course of business;

(xi) acquire by merger or consolidation with, or merge or consolidate with, or purchase substantially all or a material portion of the assets of, any corporation, partnership, association, joint venture or other business organization or division thereof;

(xii) waive, release, settle, compromise or otherwise resolve any Action, except in the ordinary course of business or whether such waivers, releases, settlements or compromises involve only the payment of monetary damages in an amount less than \$1,000,000 (net of any amounts covered by insurance) in the aggregate;

(xiii) authorize, recommend, propose or announce an intention to adopt a plan of, or otherwise enter into or effect any, complete or partial liquidation, dissolution, restructuring, recapitalization or other reorganization of the Acquiror or Merger Sub (other than the Merger);

(xiv) except as required by GAAP (or any interpretation thereof, including any new or changes to existing interpretations and guidance issued by the SEC or other Governmental Authority) or applicable Law, make any change in accounting methods, principles or practices; or

(xv) enter into any agreement to do any action prohibited under this [Section 7.5](#).

(b) During the Interim Period, Acquiror shall, and shall cause Merger Sub to comply with, and continue performing under, as applicable, Acquiror's Governing Documents, the Trust Agreement and all other agreements or Contracts to which Acquiror or its Subsidiaries may be a party. Notwithstanding anything to the contrary in this [Section 7.5](#), nothing in this Agreement shall prohibit or restrict Acquiror from extending, in accordance with Acquiror's Governing Documents, the deadline by which it must complete its Business Combination pursuant to [Section 7.10](#) hereof.

(c) Nothing herein shall require Acquiror to obtain consent from the Company to do any of the foregoing if obtaining such consent might reasonably be expected to violate applicable Law, and nothing in this Section 7.5 shall give to the Company, directly or indirectly, the right to control or direct the ordinary course of business operations of Acquiror prior to the Closing Date. Prior to the Closing Date, Acquiror shall exercise, consistent with the terms and conditions hereof, complete control and supervision of its operations, as required by Law.

Section 7.6. Post-Closing Directors and Officers of Acquiror. Subject to the terms of the Acquiror's Governing Documents, Acquiror shall take all such action within its power as may be necessary or appropriate such that at the Effective Time, the initial directors and officers of Acquiror shall be as set forth on Section 2.7(g) of the Company Disclosure Letter (as may be updated by the Company prior to Closing following written notice to Acquiror, except as otherwise provided in Section 6.1), who shall serve in such capacity in accordance with the terms of Acquiror's Governing Documents following the Effective Time.

Section 7.7. Indemnification and Insurance.

(a) From and after the Effective Time, Acquiror agrees that it shall indemnify and hold harmless each present and former director and officer of the (x) Company and each of its Subsidiaries (in each case, solely to the extent acting in their capacity as such and to the extent such activities are related to the business of the Company being acquired under this Agreement) (the "Company Indemnified Parties") and (y) Acquiror and each of its Subsidiaries (together with the Company Indemnified Parties, the "D&O Indemnified Parties") against any costs or expenses (including reasonable attorneys' fees), judgments, fines, losses, claims, damages or liabilities incurred in connection with any Action, whether civil, criminal, administrative or investigative, arising out of or pertaining to matters existing or occurring at or prior to the Effective Time, whether asserted or claimed prior to, at or after the Effective Time, to the fullest extent that the Company, Acquiror or their respective Subsidiaries, as the case may be, would have been permitted under applicable Law and its respective certificate of incorporation, certificate of formation, bylaws, limited liability company agreement or other organizational documents in effect on the date of this Agreement to indemnify such D&O Indemnified Parties (including the advancing of expenses as incurred to the fullest extent permitted under applicable Law). Without limiting the foregoing, Acquiror shall, and shall cause its Subsidiaries to (i) maintain for a period of not less than six (6) years from the Effective Time provisions in its Governing Documents concerning the indemnification and exoneration (including provisions relating to expense advancement) of Acquiror's and its Subsidiaries' former and current officers, directors, employees, and agents that are no less favorable to those Persons than the provisions of the Governing Documents of the Company, Acquiror or their respective Subsidiaries, as applicable, in each case, as of the date of this Agreement, and (ii) not amend, repeal or otherwise modify such provisions in any respect that would adversely affect the rights of those Persons thereunder, in each case, except as required by Law. Acquiror shall assume, and be liable for, each of the covenants in this Section 7.7.

(b) For a period of six (6) years from the Effective Time, Acquiror shall maintain in effect directors' and officers' liability insurance covering those Persons who are currently covered by Acquiror's, the Company's or their respective Subsidiaries' directors' and officers' liability insurance policies (true, correct and complete copies of which have been heretofore made available to Acquiror or its agents or representatives) on terms not less favorable than the terms of such current insurance coverage, except that in no event shall Acquiror be required to pay an annual premium for such insurance in excess of three hundred percent (300%) of the aggregate annual premium payable by Acquiror or the Company, as applicable, for such insurance policy for the policy period most recently ended prior to the Closing Date; *provided, however, that* (i) Acquiror may cause coverage to be extended under the current directors' and officers' liability insurance by obtaining a six (6)-year "tail" policy containing terms not materially less favorable than the terms of such current insurance coverage with respect to claims existing or occurring at or prior to the Effective Time and (ii) if any claim is asserted or made within such six (6)-year period, any insurance required to be maintained under this Section 7.7 shall be continued in respect of such claim until the final disposition thereof.

(c) Notwithstanding anything contained in this Agreement to the contrary, this Section 7.7 shall survive the consummation of the Merger indefinitely and shall be binding, jointly and severally, on Acquiror and all successors and assigns of Acquiror. In the event that Acquiror or any of its successors or assigns consolidates with or merges into any other Person and shall not be the continuing or surviving corporation or entity of such consolidation or merger or transfers or conveys all or substantially all of its properties and assets to any Person, then, and in each such case, Acquiror shall ensure that proper provision shall be made so that the successors and assigns of Acquiror shall succeed to the obligations set forth in this Section 7.7.

(d) On the Closing Date, Acquiror shall enter into customary indemnification agreements reasonably satisfactory to each of the Company and Acquiror with the post-Closing directors and officers of Acquiror, which indemnification agreements shall continue to be effective following the Closing.

Section 7.8. Acquiror Public Filings. From the date hereof through the Effective Time, Acquiror will use its best efforts to keep current and timely file all reports required to be filed or furnished with the SEC and otherwise comply in all material respects with its reporting obligations under applicable Laws.

Section 7.9. Stockholder Litigation. In the event that any litigation related to this Agreement, any Ancillary Agreement or the transactions contemplated hereby or thereby is brought, or, to the knowledge of Acquiror, threatened in writing, against Acquiror or the Board of Directors of Acquiror by any of Acquiror's stockholders prior to the Closing, Acquiror shall (a) promptly notify the Company of any such litigation, (b) keep the Company reasonably informed with respect to the status thereof, (c) provide the Company the opportunity to participate in (subject to a customary joint defense agreement), but not control, the defense of any such litigation, (d) consider in good faith the Company's advice with respect to such litigation and (e) not settle or agree to settle any such litigation without the prior written consent of the Company, such consent not to be unreasonably withheld, conditioned or delayed. The Company shall use its best efforts to support and provide information reasonably requested by the Acquiror with respect to any such litigation.

Section 7.10. Extension. Promptly after the date hereof, Acquiror will take, in accordance with applicable Law, Nasdaq rules and Acquiror's Governing Documents, all action necessary to (i) to amend Acquiror's Governing Documents to extend the time period for Acquiror to consummate its initial business combination from February 5, 2023 to June 30, 2023 (such proposal, the "Extension Proposal"), and (ii) prepare (with the reasonable cooperation of the Company) and file with the SEC a proxy statement (such proxy statement, together with any amendments or supplements thereto, the "Extension Proxy Statement") pursuant to which it shall seek the approval of the Acquiror Stockholders of the Extension Proposal. Acquiror shall use its reasonable best efforts to cause the Extension Proxy Statement to comply with the rules and regulations promulgated by the SEC, and to have the Extension Proxy Statement cleared by the SEC as promptly as practicable after such filing. Acquiror shall provide the Company a reasonable opportunity to review the Extension Proxy Statement prior to its filing with the SEC and will consider in good faith the incorporation of any comments thereto provided by the Company. As promptly as practicable after the Extension Proxy Statement is cleared by the SEC, Acquiror shall (A) cause the Extension Proxy Statement to be disseminated to the Acquiror Stockholders in compliance with applicable Law, (B) duly establish a record date for, give notice of, and convene and hold a meeting of the Acquiror Stockholders (the "Extension Meeting") in accordance with the Acquiror's Governing Documents for a date no later than two (2) Business Days prior to February 5, 2023 (or such later date as the Company and Acquiror shall agree), and (C) solicit proxies from the holders of Acquiror Common Stock to vote in favor of the Extension Proposal, and (D) provide its stockholders with the opportunity to elect to effect an Acquiror Share Redemption; *provided that*, notwithstanding anything to the contrary set forth in this Section 7.10 to the extent (1) the Acquiror Stockholder Approval is obtained at any time before the Extension Meeting is held and (2) the Closing has occurred prior to February 5, 2023, all obligations under this Section 7.10 shall terminate and be of no further force or effect. Acquiror shall, through the Acquiror Board, recommend to its stockholders the approval of the Extension Proposal, and include such recommendation in the Extension Proxy Statement. The Acquiror Board shall not withdraw, amend, qualify or modify its recommendation to the stockholders of Acquiror that they vote in favor of the Extension Proposal. Acquiror may only adjourn the Extension Meeting (i) to solicit additional proxies for the purpose of obtaining the Acquiror Extension Approval, (ii) for the absence of a quorum, (iii) to allow reasonable additional time for the filing or mailing of any supplemental or amended disclosure that Acquiror has determined in good faith after consultation with outside legal counsel is required under applicable Law and for such supplemental or amended disclosure to be disseminated and reviewed by stockholders of Acquiror prior to the Extension Meeting.

ARTICLE VIII

JOINT COVENANTS

Section 8.1. HSR Act: Other Filings.

(a) In connection with the transactions contemplated hereby, each of the Company and Acquiror shall (and, to the extent required, shall cause its Affiliates to) comply promptly but in no event later than ten (10) Business Days after the date hereof with the notification and reporting requirements of the HSR Act (the "HSR Filing"); *provided, that* in the event the Federal Trade Commission and/or the U.S. Department of Justice is closed or not accepting such filings under the HSR Act (a "Government Closure"), such days shall be extended day-for-day, for each Business Day the Government Closure is in effect. Each of the Company and Acquiror shall use reasonable best efforts to comply with any Antitrust Information or Document Request.

(b) Each of the Company and Acquiror shall (and, to the extent required, shall cause its Affiliates to) request early termination of any waiting period under the HSR Act and exercise its reasonable best efforts to (i) obtain termination or expiration of the waiting period under the HSR Act and (ii) prevent the entry, in any Action brought by an Antitrust Authority or any other Person, of any Governmental Order which would prohibit, make unlawful or delay the consummation of the transactions contemplated hereby.

(c) Acquiror and Company shall cooperate in good faith with Governmental Authorities and undertake promptly any and all action required to complete lawfully the transactions contemplated hereby as soon as practicable (but in any event prior to the Agreement End Date) and any and all action necessary or advisable to avoid, prevent, eliminate or remove the actual or threatened commencement of any proceeding in any forum by or on behalf of any Governmental Authority or the issuance of any Governmental Order that would delay, enjoin, prevent, restrain or otherwise prohibit the consummation of the Merger, including, with the Company's or Acquiror's prior written consent (which consent shall not be unreasonably withheld, conditioned, delayed or denied), as applicable, (i) proffering and consenting and/or agreeing to a Governmental Order or other agreement providing for (A) the sale, licensing or other disposition, or the holding separate, of particular assets, categories of assets or lines of business of the Company or Acquiror or (B) the termination, amendment or assignment of existing relationships and contractual rights and obligations of the Company or Acquiror and (ii) promptly effecting the disposition, licensing or holding separate of assets or lines of business or the termination, amendment or assignment of existing relationships and contractual rights, in each case, at such time as may be necessary to permit the lawful consummation of the transactions contemplated hereby on or prior to the Agreement End Date.

(d) With respect to each of the above filings, and any other requests, inquiries, Actions or other proceedings by or from Governmental Authorities, each of the Company and Acquiror shall (and, to the extent required, shall cause its controlled Affiliates to) (i) diligently and expeditiously defend and use reasonable best efforts to obtain any necessary clearance, approval, consent, or Governmental Authorization under Laws prescribed or enforceable by any Governmental Authority for the transactions contemplated by this Agreement and to resolve any objections as may be asserted by any Governmental Authority with respect to the transactions contemplated by this Agreement; and (ii) cooperate fully with each other in the defense of such matters. To the extent not prohibited by Law, the Company shall promptly furnish to Acquiror, and Acquiror shall promptly furnish to the Company, copies of any notices or written communications received by such party or any of its Affiliates from any third party or any Governmental Authority with respect to the transactions contemplated hereby, and each party shall permit counsel to the other parties an opportunity to review in advance, and each party shall consider in good faith the views of such counsel in connection with, any proposed written communications by such party and/or its Affiliates to any Governmental Authority concerning the transactions contemplated hereby; *provided, that* none of the parties shall extend any waiting period or comparable period under the HSR Act or enter into any agreement with any Governmental Authority without the written consent of the other parties. To the extent not prohibited by Law, the Company agrees to provide Acquiror and its counsel, and Acquiror agrees to provide the Company and its counsel, the opportunity, on reasonable advance notice, to participate in any substantive meetings or discussions, either in person or by telephone, between such party and/or any of its Affiliates, agents or advisors, on the one hand, and any Governmental Authority, on the other hand, concerning or in connection with the transactions contemplated hereby.

(e) Each of the Acquiror and the Company shall be responsible for and pay fifty percent (50%) of the filing fees payable to the Antitrust Authorities in connection with the HSR Filing.

Section 8.2. Preparation of Proxy Statement and Registration Statement; Stockholders' Meeting and Approvals.

(a) Registration Statement and Prospectus.

(i) As promptly as practicable after the execution of this Agreement, Acquiror and the Company shall jointly prepare and Acquiror shall file with the SEC the Registration Statement, which shall include the (x) proxy statement to be filed with the SEC as part of the Registration Statement and sent to the Acquiror Voting Stockholders relating to the Acquiror Stockholders' Meeting (such proxy statement, together with any amendments or supplements thereto, the "Proxy Statement"), and (y) a prospectus (such prospectus, together with any amendments or supplements thereto, the "Prospectus"), in connection with the registration under the Securities Act of the offering of shares of Acquiror Common Stock that constitute the Aggregate Closing Date Merger Consideration (the "Registration Statement Securities"). Each of Acquiror and the Company shall use its commercially reasonable efforts to cause the Registration Statement, including the Proxy Statement and Prospectus included therein, to comply in all material respects with the rules and regulations promulgated by the SEC, to respond as promptly as reasonably practicable to and resolve all comments received from the SEC concerning the Registration Statement, to have the Registration Statement declared effective under the Securities Act as promptly as practicable after such filing and to keep the Registration Statement effective as long as is necessary to consummate the transactions contemplated hereby. Acquiror also agrees to use its commercially reasonable efforts to obtain all necessary state securities law or "Blue Sky" permits and approvals required to carry out the transactions contemplated hereby, and the Company shall furnish all information concerning the Company, its Subsidiaries and any of their respective members or stockholders as may be reasonably requested in connection with any such action. Each of Acquiror and the Company agrees to furnish to the other party all information concerning itself, its Subsidiaries, officers, directors, managers, stockholders, and other equityholders and information regarding such other matters as may be reasonably necessary or advisable or as may be reasonably requested in connection with the Registration Statement, Proxy Statement, Prospectus, a "Current Report" on Form 8-K pursuant to the Exchange Act in connection with the transactions contemplated by this Agreement, or any other statement, filing, notice or application made by or on behalf of Acquiror, the Company or their respective Subsidiaries to any regulatory authority (including the Nasdaq) in connection with the Merger and the other transactions contemplated hereby (the "Offer Documents").

(ii) To the extent not prohibited by Law, Acquiror will advise the Company, reasonably promptly after Acquiror receives notice thereof, of the time when the Registration Statement has become effective or any supplement or amendment has been filed, of the issuance of any stop order or the suspension of the qualification of the Acquiror Common Stock for offering or sale in any jurisdiction, of the initiation or written threat of any proceeding for any such purpose, or of any request by the SEC for the amendment or supplement of the Registration Statement or for additional information. To the extent not prohibited by Law, the Company and its counsel shall be given a reasonable opportunity to review and comment on each Offer Document each time before any such document is filed with the SEC, and Acquiror shall give reasonable and good faith consideration to any comments made by the Company and its counsel. To the extent not prohibited by Law, Acquiror shall provide the Company and its counsel with (i) any comments or other communications, whether written or oral, that Acquiror or its counsel may receive from time to time from the SEC or its staff with respect to the Registration Statement or other Offer Documents promptly after receipt of those comments or other communications and (ii) a reasonable opportunity to participate in the response of Acquiror to those comments and to provide comments on that response (to which reasonable and good faith consideration shall be given), including by participating with the Company or its counsel in any discussions or meetings with the SEC.

(iii) Each of Acquiror and the Company shall ensure that none of the information supplied by or on its behalf for inclusion or incorporation by reference in (A) the Registration Statement will, at the time the Registration Statement is filed with the SEC, at each time at which it is amended and at the time it becomes effective under the Securities Act, contain any untrue statement of a material fact or omit to state any material fact required to be stated therein or necessary to make the statements therein, not misleading or (B) the Proxy Statement will, at the date it is first mailed to the Acquiror Voting Stockholders and at the time of the Acquiror Stockholders' Meeting, contain any untrue statement of a material fact or omit to state any material fact required to be stated therein or necessary in order to make the statements therein, in light of the circumstances under which they are made, not misleading.

(iv) If at any time prior to the Effective Time any information relating to the Company, Acquiror or any of their respective Subsidiaries, Affiliates, directors or officers is discovered by the Company or Acquiror, which is required to be set forth in an amendment or supplement to the Proxy Statement, Prospectus, or the Registration Statement, so that none neither of such documents would include any misstatement of a material fact or omit to state any material fact necessary to make the statements therein, with respect to the Proxy Statement, in light of the circumstances under which they were made, not misleading, the party which discovers such information shall (i) promptly notify the other parties, and (ii) promptly file an appropriate amendment or supplement describing such information with the SEC and, to the extent required by Law, disseminate such information to the Acquiror Voting Stockholders.

(v) The Company shall be responsible for and pay the filing fees payable to the SEC in connection with filing of the Registration Statement on behalf of Acquiror.

(b) Acquiror Stockholder Approval. Acquiror shall (x) as promptly as practicable after the Registration Statement is declared effective under the Securities Act, (i) cause the Proxy Statement to be disseminated to Acquiror Voting Stockholders in compliance with applicable Law, (ii) (1) duly give notice of and (2) convene and hold a meeting of its stockholders (the "Acquiror Stockholders' Meeting") in accordance with Acquiror's Governing Documents and the Nasdaq rules and regulations for a date no later than thirty (30) Business Days following the date the Registration Statement is declared effective, and (iii) solicit proxies from the holders of Acquiror Common Stock to vote in favor of each of the Transaction Proposals, and (y) provide its stockholders with the opportunity to elect to effect an Acquiror Share Redemption. Acquiror shall, through its Board of Directors, recommend to its stockholders the (A) adoption of the Acquiror Restated Charter and the Acquiror Restated Bylaws (as may be subsequently amended by mutual written agreement of the Company and Acquiror at any time before the effectiveness of the Registration Statement), including any separate or unbundled advisory proposals as are required to implement the foregoing and approval of the change of Acquiror's name to "Tigo Energy, Inc.", (B) the adoption and approval of this Agreement in accordance with applicable Law and exchange rules and regulations, (C) approval of the issuance of shares of Acquiror Common Stock in connection with the Merger pursuant to the rules of the Nasdaq, (D) approval of the adoption by Acquiror of the Incentive Equity Plan, (E) the election of directors effective as of the Closing as contemplated by Section 7.6, (F) adoption and approval of any other proposals as the SEC (or staff member thereof) may indicate are necessary in its comments to the Registration Statement or correspondence related thereto, (G) adoption and approval of any other proposals as reasonably agreed by Acquiror and the Company to be necessary or appropriate in connection with the transactions contemplated hereby, and (H) adjournment of the Acquiror Stockholders' Meeting, if necessary, to permit further solicitation of proxies because there are not sufficient votes to approve and adopt any of the foregoing (such proposals in (A) through (H), together, the "Transaction Proposals"), and include such recommendation in the Proxy Statement ("Acquiror Board Recommendation"). The Board of Directors of Acquiror shall not (I) withdraw, withhold, amend, qualify or modify, or publicly propose to withdraw, withhold, amend, qualify or modify, the Acquiror Board Recommendation or (II) following a request in writing by the Company that the Acquiror Board Recommendation be reaffirmed publicly, fail to reaffirm publicly the Acquiror Board Recommendation within ten (10) days after the Company made such request (either of the foregoing clauses (I) and (II), a "Modification in Recommendation"). To the fullest extent permitted by applicable Law, (aa) Acquiror's obligations to establish a record date for, duly call, give notice of, convene and hold the Acquiror Stockholders' Meeting shall not be affected by any Modification in Recommendation, (bb) Acquiror agrees to establish a record date for, duly call, give notice of, convene and hold the Acquiror Stockholders' Meeting and submit for approval the Transaction Proposals and (cc) Acquiror agrees that if the Acquiror Stockholder Approval shall not have been obtained at any such Acquiror Stockholders' Meeting, then Acquiror shall promptly continue to take all such necessary actions, including the actions required by this Section 8.2(b), and hold additional Acquiror Stockholders' Meetings in order to obtain the Acquiror Stockholder Approval. Acquiror may only adjourn the Acquiror Stockholders' Meeting (i) to solicit additional proxies for the purpose of obtaining the Acquiror Stockholder Approval, (ii) for the absence of a quorum and (iii) to allow reasonable additional time for the filing or mailing of any supplemental or amended disclosure that Acquiror has determined in good faith after consultation with outside legal counsel is required under applicable Law and for such supplemental or amended disclosure to be disseminated and reviewed by Acquiror Voting Stockholders prior to the Acquiror Stockholders' Meeting; *provided, that* the Acquiror Stockholders' Meeting (x) may not be adjourned to a date that is more than fifteen (15) days after the date for which the Acquiror Stockholders' Meeting was originally scheduled (excluding any adjournments required by applicable Law) and (y) shall not be originally scheduled to be held later than three (3) Business Days prior to the Agreement End Date.

(c) Company Stockholder Approvals. Upon the terms set forth in this Agreement, the Company shall, at its option, (i) seek to obtain the Company Stockholder Approvals in the form of an irrevocable written consent (the "Written Consent") of each of the Requisite Company Stockholders (pursuant to the Company Holders Support Agreement) within three (3) Business Days after the Registration Statement is declared effective under the Securities Act and delivered or otherwise made available to stockholders, or (ii) in the event the Company determines it is not able to obtain the Written Consent, the Company shall duly convene a meeting of the stockholders of the Company for the purpose of voting solely upon the adoption of this Agreement, the other agreements contemplated hereby and the transactions contemplated hereby and thereby, including the Merger, as soon as reasonably practicable after the Registration Statement is declared effective. The Company shall use its commercially reasonable efforts to obtain the Company Stockholder Approvals at such meeting of the stockholders of the Company and shall take all other action reasonably necessary or advisable to secure the Company Stockholder Approvals as soon as reasonably practicable after the Registration Statement is declared effective. The Board of Directors of the Company shall recommend to its stockholders that they approve this Agreement and the Merger.

Section 8.3. Support of Transaction. Without limiting any covenant contained in Article VI, or Article VII, Acquiror and the Company shall each, and each shall cause their respective Subsidiaries (as applicable) and its and their officers, directors, managers, employees, consultants, counsel, accounts, agents and other representatives to (a) use commercially reasonable efforts to obtain all material consents and approvals of third parties that any of Acquiror, or the Company or their respective Affiliates are required to obtain in order to consummate the Merger, and (b) take such other action as may be reasonably necessary or as another party hereto may reasonably request to satisfy the conditions of Article IX or otherwise to comply with this Agreement and to consummate the transactions contemplated hereby as soon as practicable. Notwithstanding anything to the contrary contained herein, no action taken by the Company under this Section 8.3 will constitute a breach of Section 6.1 and no action taken by the Acquiror under this Section 8.3 will constitute a breach of Section 7.5. Without breach of any representation, warranty, covenant or agreement of the Company under this Agreement or the Confidentiality Agreement and notwithstanding anything to the contrary contained herein or therein, the Company or any of its Subsidiaries may, following consultation with Acquiror in good faith, purchase and/or sell (but may not redeem (including through the Acquiror Share Redemption)) shares of Acquiror Common Stock at any time prior to the Closing; *provided, that* the Company shall cause all shares so acquired that are owned by the Company or any of its Subsidiaries as of the record date established pursuant to Section 8.2(b) to be voted in favor of each of the Transaction Proposals.

Section 8.4. Tax Matters.

(a) All transfer, documentary, sales, use, real property, stamp, registration and other similar Taxes, fees and costs (including any associated penalties and interest) ("Transfer Taxes") incurred in connection with this Agreement shall constitute Company Transaction Expenses; *provided, that* any Taxes imposed under Section 4501 of the Code (as amended by the Inflation Reduction Act of 2022, H.R. 5376) shall constitute Acquiror Transaction Expenses. The party responsible for filing any necessary Tax Returns with respect to Transfer Taxes under applicable Law shall cause such Tax Returns to be filed, and, if required by applicable Law, the other parties will join in the execution of any such Tax Returns.

(b) If the SEC requires that a Tax opinion be prepared and submitted in connection with the Registration Statement (including the Proxy Statement and/or Prospectus included therein, as applicable), whether as an exhibit to the Registration Statement or otherwise, and if such a Tax opinion is being provided by a Tax counsel, the parties hereto shall, and shall cause their Affiliates to, (i) cooperate in order to facilitate the issuance of any such Tax opinion and (ii) deliver to such counsel, to the extent requested by such counsel, a duly executed certificate reasonably satisfactory to such counsel dated as of the date requested by such counsel, containing such customary representations, warranties and covenants as shall be reasonably necessary or appropriate to enable such counsel to render any such opinion; *provided, that* notwithstanding anything herein to the contrary, nothing in this Agreement shall require (x) any counsel to the Company or its advisors to provide an opinion with respect to any Tax matters relating to or affecting the SPAC or its holders or (y) any counsel to the SPAC or its advisors to provide an opinion that the Merger qualifies for the Intended Tax Treatment; *provided, further,* that neither this provision nor any other provision in this Agreement shall require the provision of a Tax opinion by any party's counsel or advisors to be an express condition precedent to the Closing.

Section 8.5. Section 16 Matters. Prior to the Effective Time, each of the Company and Acquiror shall take all such steps as may be required (to the extent permitted under applicable Law) to cause any dispositions of shares of the Company Capital Stock or acquisitions of Acquiror Common Stock (including, in each case, securities deliverable upon exercise, vesting or settlement of any derivative securities) resulting from the transactions contemplated hereby by each individual who may become subject to the reporting requirements of Section 16(a) of the Exchange Act in connection with the transactions contemplated hereby to be exempt under Rule B-3 promulgated under the Exchange Act.

Section 8.6. Cooperation; Consultation. Prior to Closing, each of the Company and Acquiror shall, and each of them shall cause its respective Subsidiaries (as applicable) and its and their officers, directors, managers, employees, consultants, counsel, accounts, agents and other representatives to, reasonably cooperate in a timely manner in connection with any financing arrangement the parties mutually agree to seek in connection with the transactions contemplated by this Agreement (it being understood and agreed that the consummation of any such financing by the Company or Acquiror shall be subject to the parties' mutual agreement), including (if mutually agreed by the parties) (a) by providing such information and assistance as the other party may reasonably request, (b) granting such access to the other party and its representatives as may be reasonably necessary for their due diligence, and (c) participating in a reasonable number of meetings, presentations, road shows, drafting sessions, due diligence sessions with respect to such financing efforts (including direct contact between senior management and other representatives of the Company and its Subsidiaries at reasonable times and locations). All such cooperation, assistance and access shall be granted during normal business hours and shall be granted under conditions that shall not unreasonably interfere with the business and operations of the Company, Acquiror, or their respective auditors.

ARTICLE IX

CONDITIONS TO OBLIGATIONS

Section 9.1. Conditions to Obligations of Acquiror, Merger Sub, and the Company. The obligations of Acquiror, Merger Sub, and the Company to consummate, or cause to be consummated, the Merger is subject to the satisfaction of the following conditions, any one or more of which may be waived in writing by all of such parties:

- (a) The Acquiror Stockholder Approval shall have been obtained;
- (b) The Company Stockholder Approvals shall have been obtained;
- (c) The Registration Statement shall have become effective under the Securities Act and no stop order suspending the effectiveness of the Registration Statement shall have been issued and no proceedings for that purpose shall have been initiated or threatened by the SEC and not withdrawn;
- (d) The waiting period or periods under the HSR Act applicable to the transactions contemplated by this Agreement and the Ancillary Agreements shall have expired or been terminated;

(e) There shall not be in force any Governmental Order, statute, rule or regulation restraining, enjoining, or otherwise prohibiting the consummation of the Merger; *provided, that* the Governmental Authority issuing such Governmental Order has jurisdiction over the parties hereto with respect to the transactions contemplated hereby;

(f) Acquiror shall have at least \$5,000,001 of net tangible assets (as determined in accordance with Rule 3a51-1(g)(1) of the Exchange Act) either immediately prior to or upon the Closing;

(g) The shares of Acquiror Common Stock to be issued in connection with the Merger shall have been approved for listing on the Nasdaq;

(h) A copy of the Lock-Up Agreement duly executed by each stockholder of the Company;

(i) The transactions contemplated by the Sale and Purchase Agreement shall have been consummated;

(j) A copy of the BCMA Termination Agreement duly executed by Acquiror, the Company, Roth Capital Partners, LLC, and Craig-Hallum Capital Group LLC;

(k) The consents, approvals, authorizations and other requirements set forth in Section 4.4 and Section 4.5 of the Company Disclosure Letter shall have been obtained;

(l) Acquiror's shall have fulfilled its obligation to effectuate the Acquiror Share Redemptions in accordance with its Governing Documents;

(m) White & Case LLP, counsel to the Company, shall have furnished to the Underwriters such counsel's 10b-5 statement, as counsel to the Company, addressed to the Underwriters and dated as of the Closing Date, in form and substance reasonably satisfactory to the Underwriters;

(n) DLA Piper, LLP (US), counsel to the Acquiror, shall have furnished to the Underwriters such counsel's 10b-5 statement, as counsel to the Acquiror, addressed to the Underwriters and dated as of the Closing Date, in form and substance reasonably satisfactory to the Underwriters; and

(o) Ellenoff Grossman & Schole LLP, counsel to the Underwriter, shall have furnished to the Underwriters such counsel's 10b-5 statement, as counsel to the Underwriter, addressed to the Underwriters and dated as of the Closing Date, in form and substance reasonably satisfactory to the Underwriters.

Section 9.2. Conditions to Obligations of Acquiror and Merger Sub. The obligations of Acquiror and Merger Sub to consummate, or cause to be consummated, the Merger are subject to the satisfaction of the following additional conditions, any one or more of which may be waived in writing by Acquiror and Merger Sub:

(a) (i) The representations and warranties of the Company contained in Section 4.6 (*Capitalization of the Company*) shall be true and correct in all respects other than *de minimis* inaccuracies as of the Closing Date as though made on the Closing Date, except to the extent that any such representation and warranty expressly speaks as of an earlier date, in which case such representation and warranty will be true and correct as of such earlier date; (ii) the Company Fundamental Representations (other than the representations and warranties made pursuant to Section 4.6) shall be true and correct in all material respects, in each case as of the Closing Date, except with respect to such representations and warranties which speak as to an earlier date, which representations and warranties shall be true and correct in all material respects at and as of such date, except for changes after the date of this Agreement which are contemplated or expressly permitted by this Agreement or the Ancillary Agreements; and (iii) each of the representations and warranties of the Company contained in this Agreement other than the Company Fundamental Representations (disregarding any qualifications and exceptions contained therein relating to materiality, Company Material Adverse Effect or any similar qualification or exception) shall be true and correct as of the Closing Date, except with respect to such representations and warranties which speak as to an earlier date, which representations and warranties shall be true and correct at and as of such date, except for changes after the date of this Agreement which are contemplated or expressly permitted by this Agreement or the Ancillary Agreements and except for, in each case, inaccuracies or omissions that would not, individually or in the aggregate, reasonably be expected to have a Company Material Adverse Effect;

(b) Each of the covenants of the Company to be performed as of or prior to the Closing (including the execution and delivery of all agreements, certificates and instruments by the Company contemplated herein other than the certificate and form of notice to the IRS contemplated in Section 2.5(a)(iv)) shall have been performed in all material respects; *provided, that* for purposes of this Section 9.2(b), a covenant of the Company shall only be deemed to have not been performed if the Company has materially breached such material covenant and failed to cure within twenty (20) days after notice (or if earlier, the Agreement End Date);

(c) Since the date of this Agreement, there shall not have occurred a Company Material Adverse Effect that is continuing as of the Effective Time;

(d) The Company shall have delivered to the Acquiror the Financial Statements and as well as pro forma financial statements required under federal securities laws to be included in Acquiror SEC Filings in connection with the transactions contemplated by this Agreement;

(e) At the time of effectiveness of the Registration Statement and dated as of the date of effectiveness of the Registration Statement, the Company delivered, or caused to be delivered, to Acquiror from its accountants, a letter in form and substance satisfactory to Acquiror, containing statements and information of the type ordinarily included or as otherwise necessary in order to assist in receiving customary "comfort" (including as to "negative assurance" comfort) with respect to the financial statements and certain financial information contained in the Registration Statement; and

(f) The Company shall have delivered (or caused to be delivered) the Sponsor Consideration to the Sponsors pursuant to the Sale and Purchase Agreement and Section 2.5(a)(v).

Section 9.3. Conditions to the Obligations of the Company. The obligation of the Company to consummate, or cause to be consummated, the Merger is subject to the satisfaction of the following additional conditions, any one or more of which may be waived in writing by the Company:

(a) (i) The representations and warranties of Acquiror contained in Section 5.12 (*Capitalization of Acquiror*) shall be true and correct in all respects other than *de minimis* inaccuracies as of the Closing Date as though made on the Closing Date, except to the extent that any such representation and warranty expressly speaks as of an earlier date, in which case such representation and warranty will be true and correct as of such earlier date; (ii) the Acquiror Fundamental Representations (other than the representations and warranties made pursuant to Section 5.12) shall be true and correct in all material respects as of the Closing Date, except with respect to such representations and warranties which speak as to an earlier date, which representations and warranties shall be true and correct in all material respects at and as of such date, except for changes after the date of this Agreement which are contemplated or expressly permitted by this Agreement; and (iii) each of the representations and warranties of Acquiror contained in this Agreement (other than the Acquiror Fundamental Representations) (disregarding any qualifications and exceptions contained therein relating to materiality, Acquiror Material Adverse Effect or any similar qualification or exception) shall be true and correct, in each case as of the Closing Date, except with respect to such representations and warranties which speak as to an earlier date, which representations and warranties shall be true and correct at and as of such date, except for changes after the date of this Agreement which are contemplated or expressly permitted by this Agreement or the Ancillary Agreements and except for, in each case, inaccuracies or omissions that would not, individually or in the aggregate, reasonably be expected to have an Acquiror Material Adverse Effect; and

(b) Each of the covenants of Acquiror to be performed as of or prior to the Closing (including the execution and delivery of all agreements, certificates and instruments by the Acquiror and Merger Sub contemplated herein other than the IRS Form W-9 for each Sponsor contemplated by Section 2.5(b)(v)) shall have been performed in all material respects;

Section 9.4. Frustration of Conditions. Neither the Acquiror, nor Merger Sub nor the Company may rely on the failure of any condition set forth in this Article IX to be satisfied if such failure was caused by such party's failure to act in good faith or to take such actions as may be necessary to cause the conditions of the other party to be satisfied, as required by Section 8.3.

ARTICLE X

TERMINATION/EFFECTIVENESS

Section 10.1. Termination. This Agreement may be terminated and the transactions contemplated hereby abandoned at any time prior to the Closing, as follows:

(a) by mutual written consent of the Company and Acquiror;

(b) by the Company or Acquiror if any Governmental Authority shall have enacted, issued, promulgated, enforced or entered any Governmental Order which has become final and nonappealable and has the effect of making consummation of the Merger illegal or otherwise preventing or prohibiting consummation of the Merger; *provided, that* the Governmental Authority issuing such Governmental Order has jurisdiction over the parties hereto with respect to the transactions contemplated hereby;

(c) by the Company if the Acquiror Stockholder Approval shall not have been obtained by reason of the failure to obtain the required vote at the Acquiror Stockholders' Meeting duly convened therefor or at any adjournment or postponement thereof;

(d) by Acquiror if the Company Stockholder Approvals shall not have been obtained within ten (10) Business Days after the date the Registration Statement becomes effective, *provided, that* Acquiror shall have no right to terminate this Agreement at any time following the delivery to the Acquiror, or its Representatives on its behalf, of the Company Stockholder Approval, even if the Company Stockholder Approval is actually delivered following such ten (10) Business Days period after the effective date of the Registration Statement;

(e) by the Company by written notice to the Acquiror from the Company if, as of February 28, 2023 (the "Capital Raise End Date"), the Actual Capital Raise Amount calculated during the period commencing on the date of this Agreement through and including the Capital Raise End Date is less than \$15,000,000, provided, that, the Company shall have no right to terminate this Agreement pursuant to this Section 10.1(e) unless it has used commercially reasonable efforts to raise such Actual Capital Raise Amount, and provided further that if the Company determines not to exercise its termination right pursuant to this Section 10.1(e) within five (5) Business Days after the Capital Raise End Date, the Company shall no longer have a right to terminate this Agreement pursuant to this Section 10.1(e);

(f) prior to the Closing by written notice to the Company from Acquiror if (i) there is any breach of any representation, warranty, covenant or agreement on the part of the Company set forth in this Agreement, or if any representation or warranty of Company shall have become untrue, such that the conditions specified in Section 9.2(a) or Section 9.2(b) would not be satisfied at the Closing (a "Terminating Company Breach"); *provided, that* Acquiror has not waived such Terminating Company Breach and Company is not then in material breach of its representations, warranties, covenants or agreements in this Agreement; *provided further* that, for a period of up to thirty (30) days after receipt by the Company of notice from Acquiror of such breach, but only as long as the Company continues to use its commercially reasonable efforts to cure such Terminating Company Breach (the "Company Cure Period"), such termination shall not be effective, and such termination shall become effective only if the Terminating Company Breach is not cured within the Company Cure Period, or (ii) the Closing has not occurred on or before June 30, 2023 (the "Agreement End Date"), unless Acquiror is in material breach hereof and such breach or violation is the principal cause of the failure of the conditions specified in Section 9.2(a) or Section 9.2(b) on or prior to such date; or

(g) prior to the Closing, by written notice to Acquiror from the Company if (i) there is any breach of any representation, warranty, covenant or agreement on the part of Acquiror or Merger Sub set forth in this Agreement, or if any representation or warranty of the Acquiror shall have become untrue, such that the conditions specified in [Section 9.3\(a\)](#) and [Section 9.3\(b\)](#) would not be satisfied at the Closing (a "Terminating Acquiror Breach"); *provided, that* Company has not waived such Terminating Acquiror Breach and Acquiror is not then in material breach of its representations, warranties, covenants or agreements in this Agreement; *provided further*, that, for a period of up to thirty (30) days after receipt by Acquiror of notice from the Company of such breach, but only as long as Acquiror continues to exercise such commercially reasonable efforts to cure such Terminating Acquiror Breach (the "Acquiror Cure Period"), such termination shall not be effective, and such termination shall become effective only if the Terminating Acquiror Breach is not cured within the Acquiror Cure Period or (ii) the Closing has not occurred on or before the Agreement End Date, unless the Company is in material breach hereof and such breach or violation is the principal cause of the failure of the conditions specified in [Section 9.3\(a\)](#) and [Section 9.3\(b\)](#), on or prior to such date.

Section 10.2. **Effect of Termination.** In the event of the termination of this Agreement pursuant to [Section 10.1](#), this Agreement shall forthwith become void and have no effect, without any liability on the part of any party hereto or its respective Affiliates, directors, managers, officers, employees, equityholders, partners, members or representatives, other than liability of the Company, Acquiror or Merger Sub, as the case may be, for any fraud or willful and material breach of this Agreement occurring prior to such termination by a party hereto, except that (i) in the event of a termination pursuant to [Section 10.1\(g\)](#), the Company shall pay to the Sponsors, by wire transfer of immediately available funds to an account or accounts designated in writing by the Acquiror, a breakup fee of \$3,000,000 (the "Company Termination Fee"), and (ii) the provisions of [Section 6.4](#), this [Section 10.2](#) and [ARTICLE XI](#) and the Confidentiality Agreement shall survive any termination of this Agreement. Notwithstanding anything in this Agreement to the contrary, in the event that the Company Termination Fee is paid to the Sponsors in circumstances for which such fee is payable pursuant to this [Section 10.2](#), payment of the Company Termination Fee shall be the sole and exclusive remedy (whether at law, in equity, in contract, in tort or otherwise) of the Sponsors, the Acquiror and their respective Affiliates, directors, managers, officers, employees, equityholders, partners, members or representatives against the Company, the Company Stockholders and their respective Affiliates, directors, managers, officers, employees, equityholders, partners, members or representatives for any loss suffered as a result of the failure to consummate the transactions contemplated by, or for a breach or failure to perform under, this Agreement or the Ancillary Agreements, and upon payment of such amount, none of the Company, any Company Stockholders or their respective Affiliates, directors, managers, officers, employees, equityholders, partners, members or representatives shall have any further liability relating to or arising out of this Agreement or the Ancillary Agreements or the transactions contemplated thereby except for payment of the Company Termination Fee. It is agreed that the Company Termination Fee is liquidated damages and not a penalty, and the payment of the Company Termination Fee in the circumstances specified herein is supported by due and sufficient consideration.

ARTICLE XI

MISCELLANEOUS

Section 11.1. Trust Account Waiver. The Company acknowledges that Acquiror is a blank check company with the powers and privileges to effect a Business Combination. The Company further acknowledges that, as described in the Acquiror's prospectus dated August 5, 2021 and filed with the SEC (File No. 333-257779) on August 6, 2021 (the "IPO Prospectus") available at www.sec.gov, substantially all of Acquiror assets consist of the cash proceeds of Acquiror's initial public offering and private placements of its securities and substantially all of those proceeds have been deposited in a trust account for the benefit of Acquiror, certain of its public stockholders and the underwriters of Acquiror's initial public offering (the "Trust Account"). The Company acknowledges that it has been advised by Acquiror that, except with respect to interest earned on the funds held in the Trust Account that may be released to Acquiror to pay its franchise Tax, income Tax and similar obligations, the Trust Agreement provides that cash in the Trust Account may be disbursed only (i) if Acquiror completes the transactions which constitute a Business Combination, then to those Persons and in such amounts as described in the IPO Prospectus; (ii) if Acquiror fails to complete a Business Combination within the allotted time period and liquidates, subject to the terms of the Trust Agreement, to Acquiror in limited amounts to permit Acquiror to pay the costs and expenses of its liquidation and dissolution, and then to Acquiror's public stockholders; and (iii) if Acquiror holds a stockholder vote to amend Acquiror's Governing Documents to modify the substance or timing of the obligation to redeem one hundred percent (100%) of Acquiror Common Stock if Acquiror fails to complete a Business Combination within the allotted time period, then for the redemption of any Acquiror Common Stock properly tendered in connection with such vote. For and in consideration of Acquiror entering into this Agreement, the receipt and sufficiency of which are hereby acknowledged, the Company hereby irrevocably waives any right, title, interest or claim of any kind they have or may have in the future in or to any monies in the Trust Account and agrees not to seek recourse against the Trust Account or any funds distributed therefrom as a result of, or arising out of, this Agreement and any negotiations, Contracts or agreements with Acquiror; *provided, that* (x) nothing herein shall serve to limit or prohibit the Company's right to pursue a claim against Acquiror for (i) legal relief against monies or other assets held outside the Trust Account, or (ii) specific performance or other equitable relief in connection with the consummation of the transactions (including a claim for Acquiror to specifically perform its obligations under this Agreement and cause the disbursement of the balance of the cash remaining in the Trust Account (after giving effect to the Acquiror Share Redemptions) to the Company in accordance with the terms of this Agreement and the Trust Agreement) so long as such claim would not affect Acquiror's ability to fulfill its obligation to effectuate the Acquiror Share Redemptions, and (y) nothing herein shall serve to limit or prohibit any claims that the Company may have in the future against Acquiror's assets or funds that are not held in the Trust Account (including any funds that have been released from the Trust Account and any assets that have been purchased or acquired with any such funds).

Section 11.2. Waiver. Any party to this Agreement may, at any time prior to the Closing, (i) extend the time for the performance of the obligations or acts of the other parties hereto, (ii) waive any inaccuracies in the representations and warranties (of another party hereto) that are contained in this Agreement or (iii) waive compliance by the other parties hereto with any of the agreements or conditions contained in this Agreement, but such extension or waiver shall be valid only if set forth in an instrument in writing signed by the party granting such extension or waiver.

Section 11.3. Notices. All notices and other communications among the parties shall be in writing and shall be deemed to have been duly given (i) when delivered in person, (ii) when delivered after posting in the United States mail having been sent registered or certified mail return receipt requested, postage prepaid, (iii) when delivered by FedEx or other nationally recognized overnight delivery service, or (iv) when delivered by email during normal business hours (and otherwise as of the immediately following Business Day) (excluding any automated reply, such as an out-of-office notification), addressed as follows:

- (a) If to Acquiror or Merger Sub prior to the Closing, or to Acquiror after the Effective Time, to:

Roth CH Acquisition IV Co.
888 San Clemente Drive, Suite 400
Newport Beach, CA 92660
Attention: Byron Roth
Email: broth@roth.com

with copies to (which shall not constitute notice):

DLA Piper LLP (US)
2525 East Camelback Road, Suite 1000
Phoenix, AZ 85016
Attention: Steven D. Pidgeon
Email: steven.pidgeon@us.dlapiper.com

- (b) If to the Company prior to the Closing, or to the Surviving Corporation after the Effective Time, to:

Tigo Energy, Inc.
655 Campbell Technology Parkway
Suite 150
Campbell, CA 95008
Attention: Zvi Alon
Email: Zvi.Alon@tigoenergy.com

with copies to (which shall not constitute notice):

White & Case LLP
1221 Avenue of the Americas
New York, New York 10020
Attention: Colin Diamond
Bryan Luchs
Laura Katherine Mann
Email: cdiamond@whitecase.com
bryan.luchs@whitecase.com
laurakatherine.mann@whitecase.com

or to such other address or addresses as the parties may from time to time designate in writing. Copies delivered solely to outside counsel shall not constitute notice.

Section 11.4. Assignment. No party hereto shall assign this Agreement or any part hereof without the prior written consent of the other parties and any such transfer without prior written consent shall be void. Subject to the foregoing, this Agreement shall be binding upon and inure to the benefit of the parties hereto and their respective permitted successors and assigns.

Section 11.5. Rights of Third Parties. Nothing expressed or implied in this Agreement is intended or shall be construed to confer upon or give any Person, other than the parties hereto, any right or remedies under or by reason of this Agreement; *provided, however, that* the D&O Indemnified Parties and the past, present and future directors, managers, officers, employees, incorporators, members, partners, stockholders, Affiliates, agents, attorneys, advisors and representatives of the parties, and any Affiliate of any of the foregoing (and their successors, heirs and representatives), are intended third-party beneficiaries of, and may enforce, Section 11.15.

Section 11.6. Expenses. Except as otherwise set forth in this Agreement, including any filing fees related to the HSR Act which shall be paid pursuant to Section 8.1(e) and any filing fees related to the filing of the Registration Statement, which shall be paid pursuant to Section 8.2(a)(v), each party hereto shall be responsible for and pay its own expenses incurred in connection with this Agreement and the transactions contemplated hereby, including all fees of its legal counsel, financial advisers and accountants; *provided, that* if the Closing shall occur, the Surviving Corporation shall pay or cause to be paid, the Unpaid Transaction Expenses in accordance with Section 2.5(e). For the avoidance of doubt, any payments to be made (or to cause to be made) by the Surviving Corporation or the Acquiror pursuant to this Section 11.6 shall be paid upon consummation of the Merger and release of proceeds from the Trust Account.

Section 11.7. Headings; Counterparts. The headings in this Agreement are for convenience only and shall not be considered a part of or affect the construction or interpretation of any provision of this Agreement. This Agreement may be executed in two or more counterparts, each of which shall be deemed an original, but all of which together shall constitute one and the same instrument. Delivery of an executed counterpart of a signature page to this Agreement or any amendment hereto by electronic means, including DocuSign, e-mail, or scanned pages shall be effective as delivery of a manually executed counterpart to this Agreement or any amendment hereto.

Section 11.8. Company and Acquiror Disclosure Letters. The Company Disclosure Letter and the Acquiror Disclosure Letter (including, in each case, any section thereof) referenced herein are a part of this Agreement as if fully set forth herein. All references herein to the Company Disclosure Letter and/or the Acquiror Disclosure Letter (including, in each case, any section thereof) shall be deemed references to such parts of this Agreement, unless the context shall otherwise require. Any disclosure made by a party in the applicable Disclosure Letter, or any section thereof, with reference to any section of this Agreement or section of the applicable Disclosure Letter shall be deemed to be a disclosure with respect to such other applicable sections of this Agreement or sections of applicable Disclosure Letter if it is reasonably apparent on the face of such disclosure that such disclosure is responsive to such other section of this Agreement or section of the applicable Disclosure Letter. Certain information set forth in the Disclosure Letters is included solely for informational purposes and may not be required to be disclosed pursuant to this Agreement. The disclosure of any information shall not be deemed to constitute an acknowledgment that such information is required to be disclosed in connection with the representations and warranties made in this Agreement, nor shall such information be deemed to establish a standard of materiality.

Section 11.9. Entire Agreement. (i) This Agreement (together with the Company Disclosure Letter and the Acquiror Disclosure Letter), (ii) the Sponsor Support Agreement, Company Holders Support Agreement, (iii) the Lock-Up Agreement, (iv) the Registration Rights Agreement, (v) the Confidentiality Agreement, dated as of October 28, 2022, between Acquiror and the Company (the "Confidentiality Agreement"), (vi) the Purchase and Sale Agreement, (vii) the Restrictive Covenant Agreements, and (viii) the Note Agreement (clause (ii) through (viii), collectively, the "Ancillary Agreements") constitute the entire agreement among the parties to this Agreement relating to the transactions contemplated hereby and supersede any other agreements, whether written or oral, that may have been made or entered into by or among any of the parties hereto or any of their respective Subsidiaries relating to the transactions contemplated hereby. No representations, warranties, covenants, understandings, agreements, oral or otherwise, relating to the transactions contemplated hereby exist between such parties except as expressly set forth in this Agreement and the Ancillary Agreements.

Section 11.10. Amendments. This Agreement may be amended or modified in whole or in part, only by a duly authorized agreement in writing executed in the same manner as this Agreement and which makes reference to this Agreement.

Section 11.11. Publicity.

(a) All press releases or other public communications relating to the transactions contemplated hereby, and the method of the release for publication thereof, shall prior to the Closing be subject to the prior mutual approval of Acquiror and the Company, which approval shall not be unreasonably withheld by any party; *provided, that* no party shall be required to obtain consent pursuant to this Section 11.11(a) to the extent any proposed release or statement is substantially equivalent to the information that has previously been made public without breach of the obligation under this Section 11.11(a).

(b) The restriction in Section 11.11(a) shall not apply to the extent the public announcement is required by applicable securities Law, any Governmental Authority or stock exchange rule; *provided, however, that* in such an event, the party making the announcement shall use its commercially reasonable efforts to consult with the other party in advance as to its form, content and timing. Disclosures resulting from the parties' efforts to obtain approval or early termination under the HSR Act and to make any relating filing shall be deemed not to violate this Section 11.11.

Section 11.12. Severability. If any provision of this Agreement is held invalid or unenforceable by any court of competent jurisdiction, the other provisions of this Agreement shall remain in full force and effect. The parties further agree that if any provision contained herein is, to any extent, held invalid or unenforceable in any respect under the Laws governing this Agreement, they shall take any actions necessary to render the remaining provisions of this Agreement valid and enforceable to the fullest extent permitted by Law and, to the extent necessary, shall amend or otherwise modify this Agreement to replace any provision contained herein that is held invalid or unenforceable with a valid and enforceable provision giving effect to the intent of the parties.

Section 11.13. Jurisdiction; Waiver of Jury Trial.

(a) This Agreement, and all Actions based upon, arising out of, or related to this Agreement or the transactions contemplated herein, shall be governed by, and construed in accordance with, the Laws of the State of Delaware, without giving effect to principles or rules of conflict of Laws to the extent such principles or rules would require or permit the application of Laws of another jurisdiction. Any proceeding or Action based upon, arising out of or related to this Agreement or the transactions contemplated hereby must be brought in the Court of Chancery in the City of Wilmington, New Castle County, Delaware or, in the event such court lacks subject matter jurisdiction, the United States District Court sitting in Wilmington, Delaware or, in the event such federal district court lacks subject matter jurisdiction, then in the Superior Court in the City of Wilmington, New Castle County, Delaware, and each of the parties irrevocably (i) submits to the exclusive jurisdiction of each such court in any such proceeding or Action, (ii) waives any objection it may now or hereafter have to personal jurisdiction, venue or to convenience of forum, (iii) agrees that all claims in respect of the proceeding or Action shall be heard and determined only in any such court, and (iv) agrees not to bring any proceeding or Action arising out of or relating to this Agreement or the transactions contemplated hereby in any other court. In addition, each of the parties further agrees that service of any process, summons, notice or document by U.S. registered mail (or similar private providers of mail services) to such party's respective primary address shall be effective service of process with respect to any matters brought hereunder. Nothing herein contained shall be deemed to affect the right of any party to serve process in any manner permitted by Law or to commence Actions or otherwise proceed against any other party in any other jurisdiction, in each case, to enforce judgments obtained in any Action, suit or proceeding brought pursuant to this Section 11.13.

(b) EACH PARTY HERETO ACKNOWLEDGES AND AGREES THAT ANY CONTROVERSY WHICH MAY ARISE UNDER THIS AGREEMENT AND THE TRANSACTIONS CONTEMPLATED HEREBY IS LIKELY TO INVOLVE COMPLICATED AND DIFFICULT ISSUES, AND THEREFORE EACH SUCH PARTY HEREBY IRREVOCABLY, UNCONDITIONALLY AND VOLUNTARILY, TO THE FULLEST EXTENT PERMITTED BY LAW, WAIVES ANY RIGHT SUCH PARTY MAY HAVE TO A TRIAL BY JURY IN RESPECT OF ANY ACTION, SUIT OR PROCEEDING DIRECTLY OR INDIRECTLY ARISING OUT OF OR RELATING TO THIS AGREEMENT OR ANY OF THE TRANSACTIONS CONTEMPLATED HEREBY.

Section 11.14. Enforcement. The parties hereto agree that irreparable damage for which monetary damages, even if available, would not be an adequate remedy, would occur in the event that the parties do not perform their obligations under the provisions of this Agreement (including failing to take such actions as are required of them hereunder to consummate this Agreement) or any Ancillary Agreement in accordance with its specified terms or otherwise breach such provisions. The parties acknowledge and agree that (a) the parties shall be entitled to an injunction, specific performance, or other equitable relief, to prevent breaches of this Agreement or any Ancillary Agreement and to enforce specifically the terms and provisions hereof and thereof, without proof of damages, prior to the termination of this Agreement in accordance with Section 10.1, this being in addition to any other remedy to which they are entitled under this Agreement or any Ancillary Agreement, and (b) the right of specific enforcement is an integral part of the transactions contemplated by this Agreement and without that right, none of the parties would have entered into this Agreement. Each party agrees that it will not oppose the granting of specific performance and other equitable relief on the basis that the other parties have an adequate remedy at Law or that an award of specific performance is not an appropriate remedy for any reason at Law or equity. The parties acknowledge and agree that any party seeking an injunction to prevent breaches of this Agreement or any Ancillary Agreement and to enforce specifically the terms and provisions of this Agreement or any Ancillary Agreement in accordance with this Section 11.14 shall not be required to provide any bond or other security in connection with any such injunction. Without limiting the generality of the foregoing, or the other provisions of this Agreement, Acquiror acknowledges and agrees that the Company may, without breach of this Agreement, (i) with respect to any Ancillary Agreement to which the Company is a party or a third party beneficiary thereof, institute or pursue an Action directly against the counterparty(ies) to such Ancillary Agreement seeking, or seek or obtain a court order against the counterparty(ies) to such Ancillary Agreement for, injunctive relief, specific performance, or other equitable relief with respect to such Ancillary Agreement, (ii) with respect to any Ancillary Agreement to which the Company is not a party or a third party beneficiary thereof, be entitled, upon written notice to Acquiror, (A) require Acquiror to enforce its rights under any such Ancillary Agreement through the initiation and pursuit of litigation (including seeking, or seek or obtain a court order against the counterparty(ies) to such Ancillary Agreement for, injunctive relief, specific performance, or other equitable relief with respect to such Ancillary Agreement) in the event the counterparty under such Ancillary Agreement is in breach of its obligations thereunder, (B) have approval rights over Acquiror's selection of counsel for any such litigation (such approval not to be unreasonably withheld, conditioned or delayed), (C) select a separate counsel to participate alongside Acquiror's counsel in any such litigation (at the expense of the Company); *provided, that* such separate counsel shall not be entitled to control or seek court orders on Acquiror's behalf, and/or (D) fund any such litigation and (iii) require Acquiror to promptly execute, and Acquiror hereby agrees to execute and comply with, any and all documents designed to implement or facilitate the execution of the rights contemplated in this sentence.

Section 11.15. Non-Recourse. Except in the case of claims against a Person in respect of such Person's actual fraud:

(a) Solely with respect to the Company, Acquiror and Merger Sub, this Agreement may only be enforced against, and any claim or cause of action based upon, arising out of, or related to this Agreement or the transactions contemplated hereby may only be brought against, the Company, Acquiror and Merger Sub as named parties hereto; and

(b) except to the extent a party hereto (and then only to the extent of the specific obligations undertaken by such party hereto), (i) no past, present or future director, officer, employee, incorporator, member, partner, stockholder, Affiliate, agent, attorney, advisor or representative or Affiliate of the Company, Acquiror or Merger Sub and (ii) no past, present or future director, officer, employee, incorporator, member, partner, stockholder, Affiliate, agent, attorney, advisor or representative or Affiliate of any of the foregoing shall have any liability (whether in Contract, tort, equity or otherwise) for any one or more of the representations, warranties, covenants, agreements or other obligations or liabilities of any one or more of the Company, Acquiror or Merger Sub under this Agreement for any claim based on, arising out of, or related to this Agreement or the transactions contemplated hereby.

Section 11.16. Non-Survival of Representations, Warranties and Covenants. None of the representations, warranties, covenants, obligations or other agreements in this Agreement or in any certificate, statement or instrument delivered pursuant to this Agreement, including any rights arising out of any breach of such representations, warranties, covenants, obligations, agreements and other provisions, shall survive the Closing and shall terminate and expire upon the occurrence of the Effective Time (and there shall be no liability after the Closing in respect thereof), except for (a) those covenants and agreements contained herein that by their terms expressly apply in whole or in part after the Closing and then only with respect to any breaches occurring after the Closing and (b) this Article XI; *provided, that* neither this Section 11.16 nor anything else in this Agreement to the contrary shall limit the survival of any covenant or agreement of the parties under Section 2.8 or Section 8.4 which by its terms is required to be performed or complied with in whole or in part after the Closing, which covenants and agreements shall survive the Closing in accordance with their respective terms.

Section 11.17. Conflicts and Privilege.

(a) Acquiror and the Company, on behalf of their respective successors and assigns (including, after the Closing, the Surviving Corporation), hereby agree that, in the event a dispute with respect to this Agreement or the transactions contemplated hereby arises after the Closing between or among (x) the Sponsors, the stockholders or holders of other equity interests of Acquiror or the Sponsors and/or any of their respective directors, members, partners, officers, employees or Affiliates (other than the Surviving Corporation) (collectively, the "Sponsor Group"), on the one hand, and (y) the Surviving Corporation and/or any member of the Company Group, on the other hand, any legal counsel, including DLA Piper LLP (US) ("DLA"), that represented Acquiror and/or the Sponsors prior to the Closing may represent the Sponsors and/or any other member of the Sponsor Group, in such dispute even though the interests of such Persons may be directly adverse to the Surviving Corporation, and even though such counsel may have represented Acquiror in a matter substantially related to such dispute, or may be handling ongoing matters for the Surviving Corporation and/or the Sponsors. Acquiror and the Company, on behalf of their respective successors and assigns (including, after the Closing, the Surviving Corporation), further agree that, as to all legally privileged communications prior to the Closing (made in connection with the negotiation, preparation, execution, delivery and performance under, or any dispute or Action arising out of or relating to, this Agreement, any Ancillary Agreements or the transactions contemplated hereby or thereby) between or among Acquiror, the Sponsors and/or any other member of the Sponsor Group, on the one hand, and DLA, on the other hand, the attorney/client privilege and the expectation of client confidence shall survive the Merger and belong to the Sponsor Group after the Closing, and shall not pass to or be claimed or controlled by the Surviving Corporation. Notwithstanding the foregoing, any privileged communications or information shared by the Company prior to the Closing with Acquiror or the Sponsors under a common interest agreement shall remain the privileged communications or information of the Surviving Corporation.

(b) Acquiror and the Company, on behalf of their respective successors and assigns (including, after the Closing, the Surviving Corporation), hereby agree that, in the event a dispute with respect to this Agreement or the transactions contemplated hereby arises after the Closing between or among (x) the stockholders or holders of other equity interests of the Company and/or any of their respective directors, members, partners, officers, employees or Affiliates (other than the Surviving Corporation) (collectively, the "Company Group"), on the one hand, and (y) the Surviving Corporation and/or any member of the Sponsor Group, on the other hand, any legal counsel, including White & Case LLP ("W&C") that represented the Company prior to the Closing may represent any member of the Company Group in such dispute even though the interests of such Persons may be directly adverse to the Surviving Corporation, and even though such counsel may have represented Acquiror and/or the Company in a matter substantially related to such dispute, or may be handling ongoing matters for the Surviving Corporation, further agree that, as to all legally privileged communications prior to the Closing (made in connection with the negotiation, preparation, execution, delivery and performance under, or any dispute or Action arising out of or relating to, this Agreement, any Ancillary Agreements or the transactions contemplated hereby or thereby) between or among the Company and/or any member of the Company Group, on the one hand, and W&C, on the other hand, the attorney/client privilege and the expectation of client confidence shall survive the Merger and belong to the Company Group after the Closing, and shall not pass to or be claimed or controlled by the Surviving Corporation. Notwithstanding the foregoing, any privileged communications or information shared by Acquiror prior to the Closing with the Company under a common interest agreement shall remain the privileged communications or information of the Surviving Corporation.

[Remainder of page intentionally left blank]

IN WITNESS WHEREOF the parties have hereunto caused this Agreement to be duly executed as of the date first above written.

ROTH CH ACQUISITION IV CO.

By: /s/ Byron Roth
Name: Byron Roth
Title: Co-Chief Executive Officer

ROTH IV MERGER SUB INC.

By: /s/ Byron Roth
Name: Byron Roth
Title: Chief Executive Officer

TIGO ENERGY, INC.

By: /s/ Zvi Alon
Name: Zvi Alon
Title: Chief Executive Officer

[Signature Page to Agreement and Plan of Merger]

FORM OF LOCK-UP AGREEMENT

[—], 2022

Roth CH Acquisition IV Co.
888 San Clemente Drive
Suite 400
Newport Beach, CA 92660

Ladies and Gentlemen:

This letter agreement (this "**Letter Agreement**") is being delivered to you in accordance with the Agreement and Plan of Merger (the "**Merger Agreement**"), dated as of [—], 2022, by and among Roth CH Acquisition IV Co., a Delaware corporation ("**Acquiror**"), Roth IV Merger Sub Inc., a Delaware corporation and a direct, wholly-owned subsidiary of Acquiror ("**Merger Sub**"), and Tigo Energy, Inc., a Delaware corporation (the "**Company**"), pursuant to which, at the Closing (i) Merger Sub will merge with and into the Company, the separate corporate existence of Merger Sub will cease, and the Company will be the surviving corporation and a wholly-owned subsidiary of Acquiror, (ii) the Company will change its name to Tigo Energy MergeCo, Inc., and (iii) Acquiror will change its name to Tigo Energy, Inc. (the "**Transaction**"). Capitalized terms used but not otherwise defined in this Letter Agreement shall have the meanings ascribed thereto in the Merger Agreement.

In order to induce Acquiror to consummate the Transaction and for other good and valuable consideration, the receipt and sufficiency of which are hereby acknowledged, the undersigned (the "**Stockholder**") hereby agrees with Acquiror as follows (Stockholder and Acquiror collectively the "**Parties**" and each individually a "**Party**"):

1. Subject to the exceptions set forth herein, the Stockholder agrees not to, without the prior written consent of the board of directors of Acquiror, (i) sell, offer to sell, contract or agree to sell, hypothecate, pledge, grant any option to purchase or otherwise dispose of or agree to dispose of, directly or indirectly, or establish or increase a put equivalent position or liquidate or decrease a call equivalent position within the meaning of Section 16 of the Securities Exchange Act of 1934, as amended (the "**Exchange Act**"), and the rules and regulations of the Securities and Exchange Commission promulgated thereunder, any shares of Acquiror Common Stock held by it immediately after the Closing, any Acquiror Common Stock issuable upon the exercise of any options or warrants to purchase Acquiror Common Stock held by it immediately after the Closing, or any securities convertible into or exercisable or exchangeable for Acquiror Common Stock held by it immediately after the Closing or otherwise issued or issuable in connection with the Transaction (the "**Lock-up Shares**"), (ii) enter into any swap or other arrangement that transfers to another, in whole or in part, any of the economic consequences of ownership of any of such Acquiror Common Stock or securities convertible into or exercisable or exchangeable for Acquiror Common Stock, whether any such transaction is to be settled by delivery of such securities, in cash or otherwise or (iii) publicly announce any intention to effect any transaction specified in clause (i) or (ii) (the actions specified in clauses (i)-(iii), collectively, "**Transfers**", and each a "**Transfer**") during the period beginning on the Closing Date and ending on the date that is [the earlier of (i) twelve (12) months] [six (6) months]¹ after the Closing Date [and (ii) the date on which the closing price of the Acquiror Common Stock exceeds twenty dollars (\$20.00) per share (as adjusted for stock splits, stock dividends, reorganization and recapitalization) for any twenty (20) trading days within a thirty (30) trading day period following the six (6) month anniversary of the Closing]² (the "**Lock-Up Period**").

¹ **Note to Draft:** Holders of Founder Shares are subject to 12-month lockup, and the stockholders of the Company are subject to a 6-month lockup.

² **Note to Draft:** To be included for sponsor promote shares.

2. The Transfer restrictions set forth in paragraph 1 shall not apply to:
- (i) in the case of an entity, (A) Transfers to a stockholder, partner, member or affiliate of such entity, or (B) to another corporation, partnership, limited liability company, trust or other business entity that is an Affiliate of such entity, or to any investment fund or other entity controlling, controlled by, managing or managed by or under common control with such entity or affiliates of such entity (including, for the avoidance of doubt, where the entity is a partnership, to its general partner or a successor partnership or fund, or any other funds managed by such partnership);
 - (ii) in the case of an individual, Transfers by gift to members of the individual's immediate family (as defined below) or to a trust, the beneficiary of which is a member of one of the individual's immediate family, an affiliate of such person or to a charitable organization;
 - (iii) in the case of an individual, Transfers by virtue of laws of descent and distribution upon death of the individual;
 - (iv) in the case of an individual, Transfers pursuant to a qualified domestic relations order;
 - (v) in the case of an entity, Transfers by virtue of the laws of the jurisdiction of the entity's organization and the entity's organizational documents upon dissolution of the entity;
 - (vi) the exercise of any options or warrants to purchase Acquiror Common Stock (which exercises may be effected on a cashless basis to the extent the instruments representing such options or warrants permit exercises on a cashless basis), provided that the Stockholder shall comply with the Transfer restrictions applicable to such underlying Acquiror Common Stock;
 - (vii) Transfers to Acquiror to satisfy tax withholding obligations pursuant to Acquiror's equity incentive plans or arrangements;
 - (viii) Transfers to Acquiror pursuant to any contractual arrangement in effect at the Closing that provides for the repurchase by Acquiror or forfeiture of the Stockholder's shares in Acquiror or other securities convertible into or exercisable or exchangeable for shares in Acquiror in connection with the termination of the Stockholder's service to Acquiror;
 - (ix) the entry, by the Stockholder, at any time after the Closing, into any trading plan providing for the sale of Acquiror Common Stock by the Stockholder, which trading plan meets the requirements of Rule 10b5-1(c) under the Exchange Act (as may be amended from time to time); *provided, however*, that such plan does not provide for, or permit, the sale of any Acquiror Common Stock during the Lock-Up Period and no public announcement or filing is voluntarily made or required regarding such plan during the Lock-Up Period;
 - (x) Transfers of up to fifteen percent (15%) of the Acquiror Common Stock held by the Stockholder immediately after the Closing, or otherwise issued or issuable in connection with the Transaction, so long as, at the time of sale, the sales price of the Acquiror Common Stock exceeds ten dollars (\$10.00) per share (as adjusted for stock splits, stock dividends, reorganization and recapitalization); *provided*, that, in the event such Stockholder is a member of the Board of Directors of Acquiror or holds a management position in Acquiror, such Stockholder may not Transfer any Acquiror Common Stock pursuant to this clause (xi) for a period of 90 days after the Closing;

- (xi) Transfers of any shares of Acquiror Common Stock or other securities convertible into or exercisable or exchangeable for Acquiror Common Stock acquired in open market transactions after the effective time of the Merger;
- (xii) transactions in the event of completion of a liquidation, merger, stock exchange or other similar transaction which results in all of Acquiror's stockholders having the right to exchange their Acquiror Common Stock for cash, securities or other property; and
- (xiii) transactions approved by the board of directors of Acquiror in its discretion to satisfy any U.S. federal, state, or local income tax obligations of the Stockholder (or its direct or indirect owners) arising from a change in the U.S. Internal Revenue Code of 1986, as amended (the "*Code*"), or the U.S. Treasury Regulations promulgated thereunder (the "*Regulations*") after the date on which the Merger Agreement was executed by the parties thereto, and such change prevents the Transaction from qualifying as a "reorganization" pursuant to Section 368 or as a transaction that qualifies for tax deferral under Section 351 of the Code (and the Transaction does not qualify for similar tax-free treatment pursuant to any successor or other provision of the Code or Regulations taking into account such changes);

provided, however, that (x) in the case of clauses (i) through (v), such Transfer does not involve a disposition for value and (y) in the case of clauses (i) through (v), these permitted transferees must enter into a written agreement, in substantially the form of this Letter Agreement (it being understood that any references to "immediate family" in the agreement executed by such transferee shall expressly refer only to the immediate family of the Stockholder and not to the immediate family of the transferee), agreeing to be bound by the Transfer restrictions set forth herein. For purposes of this paragraph, "immediate family" shall mean a spouse, domestic partner, child, grandchild or other lineal descendant (including by adoption), father, mother, brother or sister of the Stockholder; and "affiliate" shall have the meaning set forth in Rule 405 under the Securities Act of 1933, as amended.

3. Any purported Transfer contrary to the provisions of this Letter Agreement shall be void ab initio, and Acquiror shall refuse to recognize any such purported transferee of the Acquiror Common Stock or securities convertible into or exercisable or exchangeable for Acquiror Common Stock as an equity holder for any purpose. During the Lock-Up Period, stop transfer orders shall be placed against the Acquiror Common Stock and each certificate or book entry position evidencing Acquiror Common Stock subject to Transfer restrictions hereunder shall be stamped or otherwise imprinted with a legend in substantially the following form, in addition to any other applicable legends:

"THE SECURITIES REPRESENTED HEREBY ARE SUBJECT TO RESTRICTIONS ON TRANSFER SET FORTH IN A LOCK-UP AGREEMENT BY AND AMONG THE ISSUER OF SUCH SECURITIES ("ISSUER") AND THE SECURITYHOLDER NAMED THEREIN. A COPY OF SUCH LOCK-UP AGREEMENT WILL BE FURNISHED WITHOUT CHARGE BY THE ISSUER TO THE HOLDER HEREOF UPON WRITTEN REQUEST."

4. The Stockholder shall retain all of its rights as a stockholder of Acquiror during the Lock-Up Period, including the right to vote and to receive any dividends and distributions in respect of the Acquiror Common Stock.

5. In the event that the Company releases or waives, in full or in part, any party that alone or together with its affiliates holds more than 5% of the Company's Common Stock (at the time of such release or waiver prior to Closing) or 5% of the Acquiror Common Stock (at the time of such release or waiver after the Closing) (each, a "Triggering Shareholder") from a lock-up agreement entered into in connection with the closing of the Merger, then the same percentage of Lock-up Shares held by the undersigned as the percentage of Lock-up Shares (or such equivalent term as defined in such lock-up agreement) held by such released party to such party's aggregate number of Lock-up Shares that are the subject of such waiver or release shall be immediately and fully released on the same terms from the applicable prohibition(s) set forth herein. In the event that (x) any Person enters into a letter agreement with a Triggering Shareholder relating to the subject matter hereof as contemplated by the Merger Agreement on terms and conditions that are less restrictive than those agreed to herein (or such terms and conditions are subsequently relaxed including as a result of a modification, waiver or amendment) or (y) the Company changes, amends, modifies or waives (other than to correct a typographical error) any particular provision of any other lock-up agreement entered into with a Triggering Shareholder in connection with the closing of the Merger, then the undersigned shall be offered the option (but not the requirement) to have the less restrictive terms and conditions in such letter agreement apply to the undersigned or make a corresponding change, amendment, modification or waiver, as applicable. The Stockholder hereby represents and warrants that such Stockholder has full power and authority to enter into this Letter Agreement and that this Letter Agreement constitutes the legal, valid and binding obligation of the Stockholder, enforceable in accordance with its terms. Upon request, the Stockholder will execute any additional documents necessary in connection with enforcement hereof; *provided, that* the terms of any such additional document shall not impose any additional Transfer restrictions on the Stockholder. Any obligations of the Stockholder shall be binding upon the successors and assigns of the Stockholder from and after the date hereof.

6. This Letter Agreement constitutes the entire agreement and understanding of the Parties in respect of the subject matter hereof and supersedes all prior understandings, agreements or representations by or among the Parties, written or oral, to the extent they relate in any way to the subject matter hereof or the transactions contemplated hereby. This Letter Agreement may not be changed, amended, modified or waived (other than to correct a typographical error) as to any particular provision, except by a written instrument executed by all of the Parties.

7. No Party may assign either this Letter Agreement or any of its rights, interests or obligations hereunder without the prior written consent of the other Parties. Any purported assignment in violation of this paragraph shall be void and ineffectual and shall not operate to transfer or assign any interest or title to the purported assignee. This Letter Agreement shall be binding on the Stockholder and each of its respective successors, heirs and assigns and permitted transferees.

8. This Letter Agreement, and all Actions based upon, arising out of, or related to this Letter Agreement or the transactions contemplated herein, shall be governed by, and construed in accordance with, the Laws of the State of Delaware, without giving effect to principles or rules of conflict of Laws to the extent such principles or rules would require or permit the application of Laws of another jurisdiction. Any proceeding or Action based upon, arising out of or related to this Letter Agreement or the transactions contemplated hereby must be brought in the Court of Chancery in the City of Wilmington, New Castle County, Delaware or, in the event such court lacks subject matter jurisdiction, the United States District Court sitting in Wilmington, Delaware or, in the event such federal district court lacks subject matter jurisdiction, then in the Superior Court in the City of Wilmington, New Castle County, Delaware, and each of the parties irrevocably (i) submits to the exclusive jurisdiction of each such court in any such proceeding or Action, (ii) waives any objection it may now or hereafter have to personal jurisdiction, venue or to convenience of forum, (iii) agrees that all claims in respect of the proceeding or Action shall be heard and determined only in any such court, and (iv) agrees not to bring any proceeding or Action arising out of or relating to this Letter Agreement or the transactions contemplated hereby in any other court. In addition, each of the parties further agrees that service of any process, summons, notice or document by U.S. registered mail (or similar private providers of mail services) to such party's respective primary address shall be effective service of process with respect to any matters brought hereunder. Nothing herein contained shall be deemed to affect the right of any party to serve process in any manner permitted by Law or to commence Actions or otherwise proceed against any other party in any other jurisdiction, in each case, to enforce judgments obtained in any Action, suit or proceeding brought pursuant to this Letter Agreement.

9. This Letter Agreement may be executed in multiple counterparts (including PDF and electronic signature counterparts), each of which shall be deemed an original, and all of which together shall constitute the same instrument, but only one of which need be produced.

10. This Letter Agreement shall terminate upon the earlier to occur of (i) the termination of the Merger Agreement and (ii) the expiration of the Lock-Up Period.

[remainder of page intentionally left blank]

Very truly yours,

(Name of Stockholder – Please Print)

(Signature)

(Name of Signatory if Stockholder is an entity – Please Print)

(Title of Signatory if Stockholder is an entity – Please Print)

Address: _____

TIGO ENERGY, INC.

By: _____
Name: _____
Title: _____

[Signature Page to Lock-Up Letter Agreement]

December 5, 2022

Roth CH Acquisition IV Co.
888 San Clemente Drive
Suite 400
Newport Beach, CA 92600

Tigo Energy, Inc.
655 Campbell Technology Parkway, Suite 150
Campbell, CA 95008

Re: Sponsor Support Agreement

Ladies and Gentlemen:

This letter (this "Sponsor Support Agreement") is being delivered to you in accordance with that certain Agreement and Plan of Merger (the "Merger Agreement"), dated as of the date hereof, by and among Roth CH Acquisition IV Co., a Delaware corporation ("Acquiror"), Roth IV Merger Sub Inc., a Delaware corporation and a direct, wholly-owned Subsidiary of Acquiror, and Tigo Energy, Inc., a Delaware corporation (the "Company").

The Sponsor Parties are currently, and as of immediately prior to the Closing will be, the record owners of (A) 3,336,500 shares of the outstanding shares of common stock of Acquiror, par value \$0.0001 per share (the "Acquiror Common Stock") and (B) 230,750 private warrants (the "Acquiror Warrants") each to purchase one (1) share of the Acquiror Common Stock, at a price of \$11.50, with each such Person's ownership detailed on Schedule A hereto. As described further in Paragraph 25, Schedule A will be updated from time to time to reflect any Sponsor Party ownership changes following the date hereof.

Each of the Sponsor Parties hereby acknowledges and agrees that, as of the date hereof, except as expressly incorporated herein under Paragraph 33, those certain Letter Agreements by and between Acquiror and each of the Sponsor Parties, dated August 5, 2021 (collectively, the "Prior Letter Agreements") are hereby terminated and are of no further force or effect without any further liability thereunder.

In order to induce Acquiror and the Company to enter into the Merger Agreement and for other good and valuable consideration, the receipt and sufficiency of which are hereby acknowledged, each Sponsor Party hereby agrees, severally and not jointly, with Acquiror and the Company as follows:

1. Voting Obligations. During the period beginning on the date hereof and ending on the earliest to occur of (x) the Effective Time, and (y) such date and time as the Merger Agreement shall have been terminated validly in accordance with its terms (such period, the "Interim Period"), each Sponsor Party, in its capacity as a holder of Covered Shares, agrees irrevocably and unconditionally that, at the Acquiror Stockholders' Meeting, and any other meeting of the stockholders of Acquiror (whether annual or special and whether or not an adjourned or postponed meeting, however called and including any adjournment or postponement thereof), in connection with any written consent of stockholders of Acquiror, in their capacities as such, such Sponsor Party shall, and shall cause any other holder of record of any of such Sponsor Party's Covered Shares:

- (a) when such meeting is held, to appear at such meeting, in person or by proxy, or otherwise cause the Sponsor Party's Covered Shares to be counted as present thereat for the purpose of establishing a quorum;
- (b) to vote (or duly and promptly execute and deliver an action by written consent), or cause to be voted at such meeting (or cause such consent to be duly and promptly executed and delivered with respect to), in person or by proxy, all of such Sponsor Party's Covered Shares owned as of the record date for determining holders entitled to vote at such meeting (or the record date for determining holders entitled to provide consent) in favor of all of the Transaction Proposals, including but not limited to:
 - (i) adoption of the Acquiror Restated Charter and the Acquiror Restated Bylaws (as may be subsequently revised by mutual written agreement of the Company and Acquiror at any time before the effectiveness of the Registration Statement), including any separate or unbundled advisory proposals as are required to implement the foregoing and approval of the change of Acquiror's name to "Tigo Energy, Inc.";
 - (ii) the adoption and approval of the Merger Agreement in accordance with applicable Law and exchange rules and regulations;
 - (iii) approval of the issuance of shares of the Acquiror Common Stock in connection with the Merger, and any other shares of the Acquiror Common Stock or securities convertible into or exchangeable for the Acquiror Common Stock to be issued in connection with the Transactions, if required, pursuant to the rules of the Nasdaq;
 - (iv) approval of the adoption by Acquiror of the equity plans described in Section 7.1 of the Merger Agreement;
 - (v) the election of directors effective as of the Closing as contemplated by Section 7.6 of the Merger Agreement;
 - (vi) adoption and approval of any other proposals as the SEC (or staff member thereof) may indicate are necessary in its comments to the Registration Statement or correspondence related thereto;
 - (vii) adoption and approval of any other proposals as reasonably agreed by Acquiror and the Company to be necessary or appropriate in connection with the transactions contemplated hereby; and
 - (viii) adjournment of the Acquiror Stockholders' Meeting, if necessary, to permit further solicitation of proxies because there are not sufficient votes to approve and adopt any of the foregoing.
- (c) to vote (or duly and promptly execute and deliver an action by written consent), or cause to be voted at such meeting (or cause such consent to be duly and promptly executed and delivered with respect to), in person or by proxy, all of such Sponsor Party's Covered Shares owned as of the record date for determining holders entitled to vote at such meeting (or the record date for determining holders entitled to provide consent) against (except as set forth in the Proxy Statement) the following actions or proposals:
 - (i) any Business Combination Proposal;

- (ii) any Business Combination, sale of substantial assets, dissolution, liquidation, or winding up of or by Acquiror (other than the Merger Agreement and the transactions contemplated thereby);
- (iii) against any change in the business, management or board of directors of Acquiror (other than in connection with the Transaction Proposals); and
- (iv) any other action that is intended, or would reasonably be expected, to impede, interfere with or delay or postpone the consummation of, or otherwise adversely affect, any of the Transaction Proposals or any other transaction contemplated by the Merger Agreement or any Ancillary Agreement or result in a breach of any representation, warranty, covenant or other obligation or agreement of Acquiror, Merger Sub or any Sponsor Party under the Merger Agreement or any Ancillary Agreement, in each case, to which any of the foregoing is a party (including this Sponsor Support Agreement).

Each Sponsor Party hereby agrees that it shall not commit, agree, or publicly propose any intention to take any action inconsistent with the foregoing.

The obligations of the Sponsor Parties in this Paragraph 1 shall apply whether or not the board of directors of Acquiror (or, following the Transactions, the Company) or other governing body or any committee, subcommittee or subgroup thereof recommends the Transaction Proposals or any other matters necessary or advisable for consummation of the transactions contemplated by the Merger Agreement and the Ancillary Agreements (the "Transactions"), and whether or not a Modification in Recommendation is initiated or made or such board or other governing body, committee, subcommittee or subgroup thereof otherwise changes, withdraws, withholds, qualifies or modifies, or publicly proposes to change, withdraw, withhold, qualify or modify, the Acquiror Board Recommendation.

2. New Shares. In the event that (a) any shares of the Acquiror Common Stock or other equity securities of Acquiror are issued to a Sponsor Party after the date of this Sponsor Support Agreement pursuant to any stock dividend, stock split, recapitalization, reclassification, combination or exchange of shares of the Acquiror Common Stock, on or affecting the shares of the Acquiror Common Stock owned by such Sponsor Party or otherwise, (b) a Sponsor Party purchases or otherwise acquires beneficial ownership of any shares of the Acquiror Common Stock or other equity securities of Acquiror after the date of this Sponsor Support Agreement, or (c) a Sponsor Party acquires the right to vote or share in the voting of any shares of the Acquiror Common Stock or other equity securities of Acquiror after the date of this Sponsor Support Agreement (such shares of the Acquiror Common Stock or other equity securities of Acquiror, collectively the "New Securities"), then such New Securities acquired or purchased by such Sponsor Party shall be subject to the terms of this Sponsor Support Agreement to the same extent as if they constituted the shares of the Acquiror Common Stock owned by such Sponsor Party as of the date hereof.

3. Sponsor Shares. At the Closing, Sponsor Parties shall sell to the Company 1,645,000 shares of its Acquiror Common Stock and 424,000 Acquiror Private Units on the terms as set forth in the Merger Agreement and the Sale and Purchase Agreement in exchange for \$2,300,000. The Sponsor Parties' resulting shares of the Acquiror Common Stock will be subject to certain lock-up restrictions to be entered into at the Closing by Acquiror, each holder of the Covered Shares and certain stockholders of the Company, substantially in the form attached as Exhibit D to the Merger Agreement (the "Lock-Up Agreement").

4. Exclusivity. During the Interim Period, each Sponsor Party shall not take, nor shall it permit any of its Affiliates or any of its or their respective Representatives to take, whether directly or indirectly, any action to (a) make any proposal or offer that constitutes a Business Combination Proposal (b) solicit or initiate any inquiry, indication of interest, proposal or offer or participate in any discussions or negotiations with any Person or furnish or make available to such Person any information with respect to a Business Combination Proposal (other than to make such Person aware of the provisions of this Paragraph 4) or (c) enter into any understanding, arrangement, acquisition agreement, business combination, merger agreement or similar definitive agreement, or any letter of intent, memorandum of understanding or agreement in principle, or any other commitment (whether or not legally binding) with any third party relating to a Business Combination Proposal, or (d) approve, endorse or recommend, or make any public statement approving, endorsing or recommending, any Business Combination Proposal, and in each case of clauses (a) to (d), other than to or with the Company and its respective representatives. Each Sponsor Party shall, and shall cause its Affiliates and Representatives to, immediately cease any and all existing discussions or negotiations with any Person conducted prior to the date hereof with respect to, or which is reasonably likely to give rise to or result in, a Business Combination Proposal.

5. Waiver of Certain Rights. Each Sponsor Party hereby irrevocably and unconditionally agrees:

(a) not to commence or participate in, and to take all actions necessary to opt out of any class in any class action with respect to, any action, claim, derivative or otherwise, against Acquiror, the Company, any Affiliate of Acquiror or the Company or any designee of a Sponsor Party or the Company acting in its capacity as director, officer or manager or in any similar capacity or any of their respective successors and permitted assigns relating to the negotiation, execution or delivery of this Sponsor Support Agreement, the other Ancillary Agreements, the Merger Agreement or the consummation of the Transactions (including any action (a) challenging the validity of, or seeking to enjoin the operation of, any provision of the Merger Agreement or any of the Ancillary Agreements or (b) alleging a breach of any fiduciary duty of the board of directors of Acquiror in connection with this Sponsor Support Agreement, the Merger Agreement, any other Ancillary Agreement or any of the Transactions); and

(b) not to (i) redeem its Covered Shares in connection with the Transactions, or (ii) otherwise participate in any such redemption by tendering or submitting any of its Covered Shares for redemption.

6. Reasonable Best Efforts; Regulatory Undertakings.

(a) During the Interim Period, each Sponsor Party shall (i) use reasonable best efforts to take, or cause to be taken, all actions to do, or cause to be done, all things reasonably necessary, proper or advisable under applicable Laws to consummate the Transactions on the terms and subject to the conditions set forth herein and therein and (ii) not take any action that would reasonably be expected to prevent or delay the satisfaction of any of the conditions set forth in Article IX of the Merger Agreement.

(b) Without limiting the generality of the foregoing, each Sponsor Party shall use reasonable best efforts to provide or cause to be provided (including, with respect to filings pursuant to the HSR Act, by its "Ultimate Parent Entities", as that term is defined in the HSR Act) as promptly as reasonably practicable and advisable to any Governmental Authority information and documents relating to such party as requested by such Governmental Authority or necessary, proper or advisable to permit consummation of the Transactions, including filing any notification and report form and related material required under the HSR Act and any other filing or notice that may be required with any other Governmental Authority as promptly as reasonably practicable and advisable after the date hereof and thereafter to respond as promptly as reasonably practicable and advisable to any request for additional information or documentary material relating to such party that may be made. Without limiting the generality of the preceding sentence, each Sponsor Party shall supply as promptly as practicable (and shall respond no later than ten (10) Business Days following any request) any additional information and documentary material relating to such Sponsor Party that may be requested by any Governmental Authority, and each Sponsor Party shall (i) provide, or cause to be provided, as promptly as practicable, all agreements, documents, instruments, affidavits, statements or information (including, for the avoidance of doubt, nonpublic or other confidential financial or sensitive personally identifiable information as well as personal information of senior management, directors or control persons) that may be required or requested by any Governmental Authority relating to (A) such Sponsor Party (including any of its respective directors, officers, employees, partners, members, stockholders or control persons) and (B) such Sponsor Party's structure, ownership, businesses, operations, regulatory and legal compliance, assets, liabilities, financing, financial condition or results of operations, or any of its or their directors, officers, employees, partners, members, stockholders or Affiliates, (ii) make individuals with appropriate seniority and expertise available to participate in any discussions or hearings, and (iii) prepare and file any applications, notices, registrations and requests as may be required or advisable to be filed with any Governmental Authority.

7. Transfer Restrictions. During the Interim Period, except as expressly contemplated by the Merger Agreement, each Sponsor Party shall not, and shall cause any other holder of record of any of such Sponsor Party's Covered Shares not to, Transfer, any such Sponsor Party's Covered Shares or withdraw, modify, amend, alter or change, in any manner such Sponsor Party's Covered Shares that is adverse to the Company. Notwithstanding the immediately preceding sentence, during the Interim Period, Transfers of Covered Shares that are held by any Sponsor Party or any of its Permitted Transferees (as defined below) that have entered into a written agreement contemplated by the proviso in this subsection are permitted:

- (a) to the officers, directors, members or Affiliates of the Sponsor Party or any Affiliates or family members of such Sponsor Party's officers or directors;
- (b) in the case of an individual, transfers by gift to a member of the individual's immediate family, to a trust, the beneficiary of which is a member of the individual's immediate family or an affiliate of such person, or to a charitable organization;
- (c) in the case of an individual, pursuant to a qualified domestic relations order or by virtue of laws of descent and distribution upon death of the individual;
- (d) transfers in the event of the Company's liquidation prior to the completion of an initial Business Combination;
- (e) transfers by virtue of the laws of the State of Delaware; or
- (f) to a nominee or custodian of a person or entity to whom a disposition or Transfer would be permissible under clauses (a) through (f) above;

(g) provided, however, that (A) in the case of any Transfer pursuant to any of the foregoing clauses (b), (c), and (f), such Transfer does not involve a disposition for value; (B) in the case of any Transfer pursuant to any of the foregoing clauses (a) through (f), (I) the Person effecting such Transfer provides written notice of such Transfer to the Acquiror at least two (2) Business Days prior to effecting such Transfer, (II) the Covered Shares so Transferred will remain subject to this Sponsor Support Agreement, and before such Transfer will be considered effective, each transferee will enter into a written agreement with the Acquiror and the Company, in form and substance reasonably satisfactory to the Company, agreeing to be bound by the restrictions, and subject to the obligations, in this Sponsor Support Agreement and the Lock-Up Agreement, (III) each Sponsor Party transferor will file any public report or filing required to be made under applicable securities laws (including filings under Section 16(a) of the Exchange Act) to disclose such Transfer on a timely basis; (IV) in the case of clauses (a) through (d) and (f), these permitted transferees must enter into a written agreement with the Company agreeing to be bound by the transfer restrictions herein and the other restrictions contained in this Agreement (including provisions relating to voting, the Trust Account and liquidating distributions); and (V) there will be no voluntary public disclosure or other voluntary announcement of such Transfer without the prior written consent of the Acquiror. Any Transfer in violation of the provisions of this Paragraph 7 shall be null and void ab initio and of no force or effect.

8. Other Covenants. At the Closing, each Sponsor Party hereby agrees that it shall deliver to the Company and Acquiror a duly executed counterpart to (A) the Lock-Up Agreement, and (B) the amended and restated registration rights agreement to be entered into in connection with the Closing, a substantially agreed form of which is attached as Exhibit E to the Merger Agreement (the "Registration Rights Agreement").

9. Certain Securities Law Representations and Warranties. Each Sponsor Party hereby represents and warrants as follows: (a) it has never been suspended or expelled from membership in any securities or commodities exchange or association or had a securities or commodities license or registration denied, suspended or revoked; (b) in the case of natural persons only, its biographical information furnished to Acquiror, if any (including any such information included in the Prospectus), is true and accurate in all material respects and does not omit any material information with respect to such Sponsor Party's background; (c) it is not subject to or a respondent in any legal action for any injunction, cease-and-desist order or order or stipulation to desist or refrain from any act or practice relating to the offering of securities in any jurisdiction; and (e) it has never been convicted of, or pleaded guilty to, any crime (i) involving fraud, (ii) relating to any financial transaction or handling of funds of another Person or (iii) pertaining to any dealings in any securities, and it is not currently a defendant in any such criminal proceeding.

10. Certain Payments.

(a) Except as disclosed in the Prospectus or as will be disclosed in the Proxy Statement/Prospectus to be filed with the SEC in connection with the Business Combination, no Sponsor Party, nor any Affiliate thereof, has received or shall receive from Acquiror or the Company, any finder's fee, reimbursement, consulting fee, monies in respect of any repayment of a loan or other compensation prior to, or in connection with any services rendered in order to effectuate the consummation of Acquiror's initial Business Combination (regardless of the type or form of such transaction, but including for the avoidance of doubt, the Merger).

(b) During the Interim Period, each Sponsor Party agrees not to enter into, modify or amend any Contract between or among any Sponsor Party or any Affiliate thereof, on the one hand, and the Company or any of its Subsidiaries, on the other hand, that would contradict, limit, restrict or impair any Person's ability to perform or satisfy any obligation under the Merger Agreement or any of the Ancillary Agreements.

(c) On the Closing Date, subject to the terms set forth in the Merger Agreement, Acquiror shall pay or shall cause the Surviving Corporation to pay to the Company the Unpaid Transaction Expenses.

11. Service as Officer or Director. Each Sponsor Party has full right and power, without violating any agreement to which it is bound (including, without limitation, any non-competition or non-solicitation agreement with any employer or former employer), to enter into this Sponsor Support Agreement and, as applicable, to serve as an officer, director or manager of (or in a similar capacity with respect to) Acquiror.

12. Definitions. As used herein, the following terms shall have the respective meanings set forth below. Capitalized terms used but not defined herein shall have the meanings given to them in the Merger Agreement.

(a) "Covered Shares" means all of the Acquiror Warrants, all shares of the Acquiror Common Stock, and any other Equity Interests of Acquiror (prior to the Merger) or its subsidiaries (following the Merger), of which any Sponsor Party owns as of the date hereof or acquires record or beneficial ownership after the date hereof, including by purchase, as a result of a stock dividend, stock split, recapitalization, combination, reclassification, exchange or change of such shares, or upon exercise or conversion of any securities.

(b) "Permitted Transferee" means each transferee contemplated by clauses (a) through (f) of Paragraph 7.

(c) "Related Person" means, with respect to any specified Person, any former, current or future (i) Affiliate, equityholder, member, partner, director, manager, officer, employee, agent, representative, heir, successor or assign of such specified Person or (ii) any Affiliate, equityholder, member, partner, director, manager, officer, employee, agent, representative, heir, successor or assign of any Person described in the preceding clause (i).

(d) "Representative" means, with respect to any specified Person, any director, manager, officer, employee, agent, attorney, advisor or other representative of such specified Person.

(e) "Sponsor Parties" means (i) Theodore Roth, (ii) Nazan Akdeniz, (iii) Aaron Gurewitz, as Trustee of the AMG Trust Established January 23, 2007, (iv) Adam Rothstein, (v) Andrew Costa, (vi) Byron Roth, (vii) CHLM Sponsor LLC, (viii) CR Financial Holdings, Inc., (ix) Hampstead Park Capital Management, LLC, (x) Gordon Roth, (xi) John Lipman, (xii) Matthew Day, (xiii) Molly Montgomery, (xiv) Sam Chawla, (xv) Louis J. Ellis III, (xvi) Rick Hartfiel, (xvii) Daniel M. Friedberg and (xviii) Aaron Gurewitz.

(f) "Transfer" means the (i) sale of, offer to sell, contract or agreement to sell, hypothecate, pledge, hedge, grant of any option to purchase or otherwise dispose of in any manner (including by merger, consolidation, division, operation of law or otherwise) or agreement to dispose of, directly or indirectly, or establishment or increase of a put equivalent position or liquidation with respect to or decrease of a call equivalent position within the meaning of Section 16 of the Exchange Act and the rules and regulations of the SEC promulgated thereunder with respect to, any security (including, for the avoidance of doubt, through a Transfer of equity securities in a Person who owns such security), (ii) entry into any swap or other arrangement that transfers to another, in whole or in part, any of the economic consequences of ownership of any security, whether any such transaction is to be settled by delivery of such securities, in cash or otherwise, or (iii) public announcement of any intention to effect any transaction specified in clause (i) or (ii).

(g) "Trust Account" means the trust account established for the benefit of Acquiror and certain of Acquiror's stockholders, as described in Acquiror's prospectus relating to its initial public offering filed with the SEC on August 5, 2021 (the "Prospectus").

13. Entire Agreement; Amendment; No Reliance. This Sponsor Support Agreement, the Merger Agreement and the other Ancillary Agreements constitute the entire agreement and understanding of the parties hereto in respect of the subject matter hereof and supersede all prior understandings, agreements, or representations by or among the parties hereto, written or oral, to the extent they relate in any way to the subject matter hereof or the transactions contemplated hereby. This Sponsor Support Agreement may not be changed, amended, modified or waived (other than to correct a typographical error) as to any particular provision, except by a written instrument executed by the parties hereto and any Permitted Transferee. Each of Acquiror and the Sponsor Parties hereby acknowledges and agrees, on behalf of itself, its Affiliates and its Representatives, that, in connection with its entry into this Sponsor Support Agreement and (if applicable) the Merger Agreement, the Ancillary Agreements and agreement to consummate the Transactions, none of the foregoing has relied on any representations or warranties of the Company except for those expressly set forth in the Merger Agreement.

14. Assignment. No Sponsor Party hereto may, except as set forth herein, assign either this Sponsor Support Agreement or any of its rights, interests, or obligations hereunder without the prior written consent of the Company and Acquiror; provided, that no such assignment or delegation shall relieve any Sponsor Party of its obligations hereunder. The Company and Acquiror may not assign this agreement or any of its or their rights, interests, or obligations hereunder without the prior written consent of the other parties. Any purported assignment in violation of this Paragraph 14 shall be void and ineffectual and shall not operate to transfer or assign any interest or title to the purported assignee. This Sponsor Support Agreement shall be binding on the parties hereto and their respective successors, heirs, personal representatives, permitted assigns and (in the case of the Sponsor Parties) Permitted Transferees.

15. No Third-Party Beneficiaries. Nothing in this Sponsor Support Agreement shall be construed to confer upon, or give to, any Person (other than the parties and their successors, heirs, personal representatives, permitted assigns and (in the case of the Sponsor Parties) Permitted Transferees) hereto any right, remedy or claim under or by reason of this Sponsor Support Agreement or of any covenant, condition, stipulation, promise or agreement hereof. All covenants, conditions, stipulations, promises and agreements contained in this Sponsor Support Agreement shall be for the sole and exclusive benefit of the parties hereto, and their respective successors, heirs, personal representatives and permitted assigns and (in the case of the Sponsor Parties) Permitted Transferees.

16. Captions; Counterparts. The headings and captions in this Sponsor Support Agreement are for convenience of reference only and shall not be considered a part of, modify or affect the construction or interpretation of any provision of this Sponsor Support Agreement. This Sponsor Support Agreement may be executed in two or more counterparts, each of which shall be deemed an original, but all of which together shall constitute one and the same instrument.

17. Severability. This Sponsor Support Agreement shall be deemed severable, and the invalidity or unenforceability of any term or provision hereof shall not affect the validity or enforceability of this Sponsor Support Agreement or of any other term or provision hereof. Furthermore, in lieu of any such invalid or unenforceable term or provision, the parties hereto intend that there shall be added as a part of this Sponsor Support Agreement a provision as similar in terms to such invalid or unenforceable provision as may be possible and be valid and enforceable.

18. Governing Law; Jurisdiction; Waiver of Jury Trial; Enforcement. Section 11.13 (*Jurisdiction; Waiver of Jury Trial*) and Section 11.14 (*Enforcement*) of the Merger Agreement are incorporated herein by reference, *mutatis mutandis*.

19. Notices. All notices and other communications among the parties hereto shall be in writing and shall be deemed to have been duly given (a) when delivered in person, (b) when delivered after posting in the United States mail having been sent registered or certified mail return receipt requested, postage prepaid, (c) when delivered by FedEx or other nationally recognized overnight delivery service or (d) when e-mailed without any "bounce back" or similar error message, addressed as follows:

If to Acquiror:

Roth CH Acquisition IV Co.
888 San Clemente Drive
Suite 400
Newport Beach, CA 92660
Attention: Byron Roth
Email: broth@roth.com

with copies to (which shall not constitute notice):

DLA Piper LLP (US)
2525 East Camelback Road, Suite 1000
Phoenix, AZ 85016
Attention: Steven D. Pidgeon
Email: steven.pidgeon@us.dlapiper.com

If to the Company:

Tigo Energy, Inc.
655 Campbell Technology Parkway, Suite 150
Campbell, CA 95008
Attention: Zvi Alon
Email: Zvi.Alon@tigoenergy.com

with copies to (which shall not constitute notice):

White & Case LLP
609 Main Street, Suite 2900
Houston, Texas 77002
Attention: Colin Diamond
Bryan Luchs
Laura Katherine Mann
Email: cdiamond@whitecase.com
bryan.luchs@whitecase.com
laurakatherine.mann@whitecase.com

If to the Sponsor Parties:

At the address set forth under each Sponsor Party's signature page below.

20. Termination. This Sponsor Support Agreement shall terminate (a) upon the valid termination of the Merger Agreement; or (b) as mutually agreed in writing by the parties to this Sponsor Support Agreement; provided, that no such termination shall relieve any party hereto from any liability resulting from its pre-termination breach of this Sponsor Support Agreement.

21. Other Representations and Warranties. Each Sponsor Party hereby represents and warrants (severally and not jointly) to Acquiror and the Company as follows:

(a) if such Person is not an individual, it is duly organized, validly existing and in good standing under the laws of the jurisdiction in which it is incorporated, formed, organized or constituted, and the execution, delivery and performance of this Sponsor Support Agreement and the consummation of the transactions contemplated hereby are within such Person's corporate, limited liability company or other organizational powers and have been duly authorized by all necessary corporate, limited liability company or other organizational actions on the part of such Person;

(b) if such Person is an individual, such Person has full legal capacity, right and authority to execute and deliver this Sponsor Support Agreement and to perform its obligations hereunder;

(c) this Sponsor Support Agreement has been duly executed and delivered by such Person and, assuming due authorization, execution and delivery by the other parties to this Sponsor Support Agreement, this Sponsor Support Agreement constitutes a legally valid and binding obligation of such Person, enforceable against such Person in accordance with the terms hereof (except as enforceability may be limited by bankruptcy Laws, other similar Laws affecting creditors' rights and general principles of equity affecting the availability of specific performance and other equitable remedies);

(d) the execution and delivery of this Sponsor Support Agreement by such Person do not, and the performance by such Person of its obligations hereunder will not, (A) if such Person is not an individual, conflict with or result in a violation of the organizational documents of such Person, or (B) require any consent, waiver or approval that has not been given or other action that has not been taken by any third party (including under any Contract binding upon such Person or such Person's Covered Shares), in each case, to the extent such consent, waiver or approval or other action (or omission of which action) would prevent, enjoin or delay the performance by such Person of its obligations under this Sponsor Support Agreement;

(e) there is no Action pending or, to the knowledge of such Person, threatened against such Person before (or, in the case of a threatened Action, that would be before) any arbitrator or any Governmental Authority, which in any manner challenges all or any part of this Sponsor Support Agreement or any of the transactions contemplated hereby or seeks to, or would reasonably be expected to, prevent, enjoin or delay the performance by such Person of its obligations under this Sponsor Support Agreement;

(f) except as disclosed pursuant to Section 5.13 (*Brokers' Fees*) of the Merger Agreement, no financial advisor, investment banker, broker, finder or other similar intermediary is entitled to any fee or commission from such Person, Acquiror or the Company (or any of their respective Subsidiaries), or any of its Subsidiaries or any of their respective Affiliates in connection with the Merger Agreement, this Sponsor Support Agreement or any other Ancillary Agreement or any of the respective transactions contemplated thereby and hereby, in each case, based upon any arrangement or agreement made by or, to the knowledge of such Person, on behalf of such Person, for which Acquiror, the Company, or any of their respective Affiliates would have any obligations or liabilities of any kind or nature;

(g) such Person has had the opportunity to read the Merger Agreement and this Sponsor Support Agreement and has had the opportunity to consult with its tax, legal and other advisors;

(h) such Person has not entered into, and will not enter into, any agreement that would restrict, limit or interfere with the performance of such Person's obligations hereunder;

(i) such Person has good and valid title to the number of Covered Shares set forth opposite such Person's name in the columns titled "Acquiror Common Stock", "Acquiror Public Placement Warrants" and "Acquiror Private Placement Warrants," respectively, in Schedule A hereto, and there exist no Lien or any other limitation or restriction (including, without limitation, any restriction on the right to vote, sell or otherwise dispose of such securities other than transfer restrictions under the U.S. Securities Act of 1933, as amended, and the rules and regulations promulgated thereunder) affecting any such securities, other than pursuant to (A) this Sponsor Support Agreement, (B) the Acquiror bylaws, (C) the Acquiror Original Charter, (D) the Merger Agreement or (E) any applicable securities Laws;

(j) the Acquiror Common Stock and the Acquiror Warrants listed on Schedule A are the only equity securities in Acquiror (including, without limitation, any equity securities convertible into, or which can be exercised or exchanged for, equity securities of Acquiror) owned of record or beneficially by such Person as of the date hereof and as of immediately prior to the consummation of the Transactions on the Closing Date and such Person (or such Person's general partner or managing member) has the sole power to dispose of (or sole power to cause the disposition of) and the sole power to vote (or sole power to direct the voting of) such Acquiror Common Stock and Acquiror Warrants and none of such Acquiror Common Stock or Acquiror Warrants is subject to any proxy, voting trust or other agreement or arrangement with respect to the voting of such Acquiror Common Stock or Acquiror Warrants, except as provided in this Sponsor Support Agreement;

(k) such Person is not currently (and at all times through the Closing will refrain from being or becoming) a member of a "group" (within the meaning of Section 13(d)(3) or Section 14(d)(2) of the Exchange Act, or any successor provision), including any group acting for the purpose of acquiring, holding or disposing of equity securities of Acquiror (within the meaning of Rule 13d-5(b)(1) under the Exchange Act); and

(l) except as disclosed in the Prospectus, neither such Person nor any of its Affiliates or any member of its immediate family is a party to, or has any rights with respect to or arising from, any material Contract with Acquiror or any of its Subsidiaries.

22. Equitable Adjustments. If, and as often as, there are any changes in Acquiror, the Acquiror Common Stock or the Acquiror Warrants by way of stock split, stock dividend, combination or reclassification, or through merger, consolidation, reorganization, recapitalization or business combination, or by any other means, equitable adjustment shall be made to the provisions of this Sponsor Support Agreement, as may be required, so that the rights, privileges, duties and obligations hereunder shall continue with respect to Acquiror, the Acquiror Common Stock or the Acquiror Warrants, each as so changed, provided, however, that this Paragraph 22 shall not (a) be construed to permit any Sponsor Party to take any action with respect to their respective securities that is prohibited by the terms and conditions of this Sponsor Support Agreement or (b) apply to any other transactions expressly contemplated by this Sponsor Support Agreement, the Merger Agreement or any Ancillary Agreement to the extent consummated in accordance with the terms contemplated by this Sponsor Support Agreement, the Merger Agreement and/or such Ancillary Agreement, as applicable.

23. Costs and Expenses. Each party to this Sponsor Support Agreement will pay its own costs and expenses (including legal, accounting and other fees) relating to the negotiation, execution, delivery and performance of this Sponsor Support Agreement. Without limiting the foregoing, if the aggregate amount of Acquiror Transaction Expenses exceeds the Acquiror Transaction Expenses Cap, then, at the election of Byron Roth made at or prior to Closing by delivery of prior written notice thereof to Acquiror and the Company (the "Excess Expense Notice"), Sponsors (as such term is defined in the Merger Agreement) shall either (A) pay to Acquiror at Closing the Excess Expense Amount in cash by wire transfer of immediately available funds, or (B) effective immediately following Closing, forfeit a number of shares of Acquiror Common Stock then held by Sponsors immediately following Closing equal to the quotient obtained by dividing the Excess Expense Amount by \$10.00, and Sponsors shall immediately thereafter surrender such forfeited shares to Acquiror, whereupon such shares shall be cancelled and retired on the books and records of the Acquiror. If Sponsor shall fail to deliver the Excess Expense Notice to Acquiror and the Company prior to the Closing, then Sponsors shall be deemed to have made the election referred to in clause (B) of the immediately preceding sentence, as applicable.

24. Interpretation. Section 1.2 (*Construction*) of the Merger Agreement is incorporated herein by reference, *mutatis mutandis*. Wherever this Sponsor Support Agreement uses “it”, “its” or derivations thereof to refer to natural person or Sponsor Parties, such references shall be deemed references to “her”, “him” or “his”, as applicable.

25. Updates to Schedule A: Admission of New Sponsor Parties. During the Interim Period, each Sponsor Party shall promptly notify the Company of any increase, decrease or other change in the number of shares of the Acquiror Common Stock, the Acquiror Private Placement Warrant, or other Covered Shares held by or on behalf of such Sponsor Party (for the avoidance of doubt, such Sponsor Party acknowledges and agrees that Paragraph 7 prohibits all Transfers of its Covered Shares during the Interim Period except to Permitted Transferees). Promptly following each such notification, the Company shall update, or cause to be updated, Schedule A to reflect the applicable changes as they relate to the Acquiror Common Stock or the Acquiror Warrants or other Covered Shares, and such updated Schedule A shall control for all purposes of this Sponsor Support Agreement (unless and until it is later updated in accordance with this Paragraph 25). Any update to Schedule A in accordance with this Sponsor Support Agreement shall not be deemed an amendment to this Sponsor Support Agreement for purposes of Paragraph 13.

26. Additional Agreements. Each of the Sponsor Parties hereby represents and warrants to Acquiror and the Company, severally and not jointly, that (a) on or prior to the date hereof, it has delivered to Acquiror and the Company a capitalization table showing all of the direct equity owners of each of the Sponsor Parties (the “Sponsor Cap Table”) and (b) the Sponsor Cap Table is true, correct and complete in all respects as of the date hereof. Notwithstanding anything to the contrary herein, following the date hereof, the Sponsor Parties shall provide written notice to Acquiror and the Company promptly following any change in the Sponsor Cap Table.

27. Specific Performance. The parties agree that irreparable damage for which monetary damages, even if available, would not be an adequate remedy, would occur in the event that the parties do not perform their obligations under the provisions of this Sponsor Support Agreement (including failing to take such actions as are required of them hereunder to consummate this Sponsor Support Agreement) in accordance with its specified terms or otherwise breach such provisions. The parties acknowledge and agree that (a) the parties shall be entitled to an injunction, specific performance, or other equitable relief, to prevent breaches of this Sponsor Support Agreement and to enforce specifically the terms and provisions hereof, without proof of damages, prior to the valid termination of this Sponsor Support Agreement in accordance with Paragraph 20, this being in addition to any other remedy to which they are entitled under this Sponsor Support Agreement, and (b) the right of specific enforcement is an integral part of the transactions contemplated by this Sponsor Support Agreement and without that right, none of the parties would have entered into this Sponsor Support Agreement.

28. Further Assurances. Each of the parties hereto agrees to execute and deliver hereafter any further document, agreement or instrument of assignment, transfer or conveyance as may be necessary or desirable to effectuate the purposes hereof and as may be reasonably requested in writing by another party hereto. Each Sponsor Party further agrees not to commence or participate (in a manner adverse to Acquiror, the Company or any of their respective Related Persons) in, and agrees to take all actions necessary to opt out of any class in any class action with respect to, any Action, derivative or otherwise, against Acquiror, the Company or any of their respective Related Persons, relating to the negotiation, execution or delivery of the Merger Agreement, any of the Ancillary Agreements or any of the Transactions (including any Action (a) challenging the validity of, or seeking to enjoin the operation of, any provision of the Merger Agreement or any of the Ancillary Agreements or (b) alleging a breach of any fiduciary duty of the board of directors of Acquiror in connection with this Sponsor Support Agreement, the Merger Agreement, any other Ancillary Agreement or any of the Transactions). Notwithstanding anything herein to the contrary, nothing in this Sponsor Support Agreement shall limit or restrict the ability of each Sponsor Party to enforce its rights under this Sponsor Support Agreement or any other Ancillary Agreement to which such Sponsor Party is a party or seek any other remedies with respect to any breach of this Sponsor Support Agreement or such other Ancillary Agreement by any other party hereto or thereto, including by commencing any Action in connection therewith.

29. Disclosure. Each Sponsor Party hereby authorizes each of the Company and Acquiror to publish and disclose, in any announcement, filing or disclosure required to be made by any Governmental Order or other applicable Law or the rules of any national securities exchange or as requested by the SEC, each Sponsor Party's identity and ownership of Covered Shares and each Sponsor Party's obligations under this Sponsor Support Agreement.

30. Trust Account Waiver. Section 5.8 (*Trust Account*) of the Merger Agreement is hereby incorporated into this Sponsor Support Agreement, mutatis mutandis.

31. Acknowledgement. Each Sponsor Party understands and acknowledges that the Company's willingness to enter into the Merger Agreement was conditioned upon and materially induced by each Sponsor Party's execution and delivery of this Sponsor Support Agreement and performance of its obligations hereunder.

32. Several and Not Joint Obligations. The representations, warranties, covenants, agreements, obligations and liability of the Sponsor Parties shall be several, and not joint. Notwithstanding any other provision of this Sponsor Support Agreement, in no event will any Sponsor Party be liable for any other Person's breach of such other Person's representations, warranties, covenants, or agreements contained in this Sponsor Support Agreement, the Merger Agreement or any other Ancillary Agreement.

33. Prior Letter Agreement. Sections 2, 3, 4, 7, 9, 10, and 12 of the Prior Letter Agreements are hereby incorporated by reference mutatis mutandis as if fully set forth herein.

[Signature Pages Follows]

IN WITNESS WHEREOF, the parties hereto have executed this Sponsor Support Agreement on the day and year first above written.

SPONSOR PARTIES:

CR FINANCIAL HOLDINGS, INC.

By: /s/ Gerald Mars
Name: Gerald Mars
Title: CFO

ROTH CAPITAL PARTNERS, LLC

By: /s/ Byron Roth
Name: Byron Roth
Title: CEO

/s/ Aaron M. Gurewitz
Aaron M. Gurewitz, as Trustee of the AMG Trust established January 23, 2007

/s/ Gordon Roth
Gordon Roth

/s/ Theodore Roth
Theodore Roth

/s/ Matt Day
Matt Day

/s/ Byron Roth
Byron Roth

/s/ Andrew Costa
Andrew Costa

CHLM SPONSOR LLC

By: /s/ Steven Dyer
Name: Steven Dyer
Title: CEO

HAMPSTEAD PARK CAPITAL MANAGEMENT, LLC

By: /s/ Daniel Friedberg
Name: Daniel Friedberg
Title: Managing Partner

/s/ Nazan Akdeniz
Nazan Akdeniz

/s/ Lou Ellis
Lou Ellis

/s/ John Lipman
John Lipman

/s/ Molly Montgomery
Molly Montgomery

/s/ Adam Rothstein
Adam Rothstein

/s/ Sam Chawla
Sam Chawla

[Signature Page to the Sponsor Support Agreement]

/s/ Aaron M. Gurewitz

Aaron M. Gurewitz

/s/ Daniel M. Friedberg

Daniel M. Friedberg

/s/ Rick Hartfiel

Rick Hartfiel

ACQUIROR

ROTH CH ACQUISITION IV CO.

By: /s/ Byron Roth

Name: Byron Roth

Title: Co-Chief Executive Officer

[Signature Page to the Sponsor Support Agreement]

IN WITNESS WHEREOF, the parties hereto have executed this Sponsor Support Agreement on the day and year first above written.

COMPANY:

TIGO ENERGY, INC.

By: /s/ Zvi Alon
Name: Zvi Alon
Title: CEO

[Signature Page to the Sponsor Support Agreement]

Schedule A
Ownership of Securities
(as of December 5, 2022)

Sponsor Party	Acquiror Common Stock	Acquiror Private Warrants	Other Covered Shares
Aaron M. Gurewitz, as Trustee of the AMG Trust established January 23, 2007	128,386.00	8,879.00	-
Adam Rothstein	33,034.00	2,284.50	-
Andrew Costa	17,791.00	-	-
Byron Roth	480,609.00	33,238.50	-
CHLM Sponsor LLC	801,091.00	55,403.00	-
CR Financial Holdings, Inc.	762,528.00	52,736.00	-
Gordon Roth	98,810.00	6,833.50	-
Hampstead Park Capital Management, LLC	33,034.00	2,284.50	-
John Lipman	801,091.00	55,403.00	-
Lou Ellis	6,722.00	465.00	-
Matt Day	35,583.00	-	-
Molly Montgomery	33,034.00	2,284.50	-
Nazan Akdeniz	6,722.00	465.00	-
Roth Capital Partners, LLC	8,568.00	4,284.00	-
Sam Chawla	33,034.00	2,284.50	-
Theodore Roth	56,463.00	3,905.00	-
Total	3,336,500	230,750	-

[Schedule A to the Sponsor Support Agreement]

Roth CH Acquisition IV Co.
888 San Clemente Drive
Suite 400
Newport Beach, CA 92600

Tigo Energy, Inc.
655 Campbell Technology Parkway, Suite 150
Campbell, CA 95008

Re: Company Holders Support Agreement

Ladies and Gentlemen:

This letter (this "Agreement") is being delivered to you in accordance with that certain Agreement and Plan of Merger (the "Merger Agreement"), dated as of the date hereof, by and among Roth CH Acquisition IV Co., a Delaware corporation ("Acquiror"), ROCG IV Merger Sub Inc., a Delaware corporation and a direct, wholly-owned Subsidiary of Acquiror (the "Merger Sub"), and Tigo Energy, Inc., a Delaware corporation (the "Company").

As of the date hereof, the undersigned stockholders of the Company (each, a "Company Stockholder"), collectively constituting the Requisite Company Stockholders, are the holders of record and the "beneficial owners" (within the meaning of Rule 13d-3 under the Exchange Act) of such number of shares of Company Common Stock, shares of Company Preferred Stock, Company Options and Company Warrants indicated opposite each of their names on Schedule A attached hereto (all such Equity Interests, together with any Equity Interests of which ownership of record or the power to vote (including, without limitation, by proxy or power of attorney) is hereafter acquired by any such Company Stockholder during the period from the date hereof through the termination of this Agreement are referred to herein as such Company Stockholder's "Covered Shares");

In order to induce Acquiror and the Company to enter into the Merger Agreement and for other good and valuable consideration, the receipt and sufficiency of which are hereby acknowledged, each of the undersigned Company Stockholders hereby agrees, severally and not jointly, with Acquiror and the Company as follows:

1. Voting Obligations. During the period beginning on the date hereof and ending on the earliest to occur of (x) the Effective Time, and (y) such date and time as the Merger Agreement shall have been terminated validly in accordance with its terms (such period, the "Interim Period"), each Company Stockholder, solely in its capacity as a holder of Covered Shares, irrevocably and unconditionally agrees that, at any meeting of the Company's stockholders (whether annual or special and whether or not an adjourned or postponed meeting, however called and including any adjournment or postponement thereof), in connection with any written consent of the Company's stockholders, in their capacities as such, such Company Stockholder shall, and shall cause any other holder of record of any of such Company Stockholder's Covered Shares:

(a) if and when such meeting is held, to appear at such meeting, in person or by proxy, or otherwise cause the Company Stockholder's Covered Shares to be counted as present thereat for the purpose of establishing a quorum;

(b) to vote (or duly and promptly execute and deliver an action by written consent), or cause to be voted at such meeting (or cause such consent to be duly and promptly executed and delivered with respect to), in person or by proxy, all of such Company Stockholder's Covered Shares owned as of the record date for determining holders entitled to vote at such meeting (or the record date for determining holders entitled to provide consent) in favor of the approval of the Merger Agreement and the transactions contemplated thereby (for purposes of this Agreement, the "Transaction Proposals");

(c) to vote (or duly and promptly execute and deliver an action by written consent), or cause to be voted at such meeting (or cause such consent to be duly and promptly executed and delivered with respect to), in person or by proxy, all of such Company Stockholder's Covered Shares owned as of the record date for determining holders entitled to vote at such meeting (or the record date for determining holders entitled to provide consent) against the following actions or proposals:

(i) any Acquisition Proposal;

(ii) any merger agreement, merger, consolidation, combination, sale of substantial assets, reorganization, recapitalization, dissolution, liquidation or winding up of or by the Company (other than the Merger Agreement, a Capital Raising Transaction or the transactions contemplated thereby);

(iii) any change in the business, management or board of directors of the Company (other than in connection with the Transaction Proposals, the Merger Agreement or a Capital Raising Transaction); and

(iv) any other action that is intended, or would reasonably be expected, to materially impede, interfere with or delay or postpone the consummation of, or otherwise adversely affect, any of the Transaction Proposals or any other transaction contemplated by the Merger Agreement or any Ancillary Agreement or result in a breach of any representation, warranty, covenant or other obligation or agreement of the Company under the Merger Agreement or any Ancillary Agreement that would result in the failure of any condition set forth in Section 9.1 or Section 9.3 of the Merger Agreement to be satisfied, or result in a breach of any covenant, representation or warranty of the Company Stockholder contained in this Agreement.

Each Company Stockholder hereby agrees that it shall not commit, agree, or publicly propose any intention to take any action inconsistent with the foregoing.

The obligations of the Company Stockholders in this Paragraph 1 shall apply whether or not the board of directors of the Company or other governing body or any committee, subcommittee or subgroup thereof recommends the Transaction Proposals or any other matters necessary or advisable for consummation of the transactions contemplated by the Merger Agreement and the Ancillary Agreements (the "Transactions"), and whether or not such board or other governing body, committee, subcommittee or subgroup thereof changes, withdraws, withholds, qualifies or modifies, or publicly proposes to change, withdraw, withhold, qualify or modify, its recommendation with respect to the Transaction Proposals.

2. Exclusivity. During the Interim Period, each Company Stockholder shall not take, nor shall it permit any of its controlled Affiliates, and shall direct its and their respective Representatives not to take, whether directly or indirectly, any action to (a) knowingly solicit or initiate any inquiries, indications of interest, proposal or offer by any third party with respect to an Acquisition Proposal, (b) furnish or make available to any third party information in respect of, or access to, the business, properties, assets or personnel of the Company or any of the Company's Subsidiaries in connection with an Acquisition Proposal, or (c) enter into any acquisition agreement, merger agreement or similar definitive agreement, or any letter of intent, memorandum of understanding or agreement in principle, or any other agreement relating to an Acquisition Proposal, in each case, except in connection with a Capital Raising Transaction. Each Company Stockholder shall, and shall cause its controlled Affiliates and shall direct its Representatives to, immediately cease any and all existing discussions or negotiations with any Person conducted prior to the date hereof with respect to, or which is reasonably likely to give rise to or result in, an Acquisition Proposal.

3. Waiver of Certain Rights. Each Company Stockholder hereby irrevocably and unconditionally agrees not to commence or participate in, and to take all actions necessary to opt out of any class in any class action with respect to, any claim, derivative or otherwise, against Acquiror, the Company, any Affiliate of Acquiror or the Company or any designee of Acquiror or the Company acting in its capacity as director, officer or manager or in any similar capacity or any of their respective successors and permitted assigns relating to the negotiation, execution or delivery of this Agreement.

4. Transfer Restrictions. During the Interim Period, except as expressly contemplated by the Merger Agreement, each Company Stockholder shall not, and shall cause any other holder of record of any of such Company Stockholder's Covered Shares not to, Transfer, any such Company Stockholder's Covered Shares. Notwithstanding the immediately preceding sentence, during the Interim Period, Transfers of Covered Shares that are held by any Company Stockholder or any of its Permitted Transferees (as defined below) that have entered into a written agreement contemplated by the proviso in this subsection are permitted:

(a) to the Company Stockholder's officers or directors, any Affiliates or family members of such Company Stockholder's officers or directors, to any other Company Stockholder, the Acquiror, the Sponsor, any respective then-current directors, officers, members or partners of any other Company Stockholder, the Acquiror, or the Sponsor or their respective Affiliates, any Affiliates of any other Company Stockholder, the Acquiror or the Sponsor, or any employees of such Affiliates;

(b) as a bona fide gift or gifts or in the case of an individual, by gift to a member of the individual's immediate family or to a trust, the beneficiary of which is a member of the individual's immediate family, an Affiliate of such Person or to a charitable organization (other than with respect to any such gift for which the donor receives (A) equity interest of such donee or (B) such donee's interests in the donor);

(c) in the case of an individual, by will or other testamentary document or device or by virtue of laws of descent and distribution upon death of the individual;

(d) for bona fide estate planning purposes;

(e) in the case of an individual, pursuant to a qualified domestic relations order, divorce settlement, divorce decree or separation agreement;

(f) to a partnership, limited liability company or other entity of which the transferor and the immediate family of the transferor are the legal and beneficial owner of all of the outstanding equity securities or similar interests;

(g) to a nominee or custodian of a person or entity to whom a disposition or Transfer would be permissible under clauses (a) through (f) above;

(h) if the transferor is a corporation, partnership, limited liability company, trust or other business entity, (i) to another corporation, partnership, limited liability company, trust or other business entity that is an Affiliate of the transferor, or to any investment fund or other entity controlling, controlled by, managing or managed by or under common control with the transferor or affiliates of the transferor (including, for the avoidance of doubt, where the transferor is a partnership, to its general partner or a successor partnership or fund, or any other funds managed by such partnership), or (ii) as part of a distribution to members or stockholders of the transferor;

(i) to the Company pursuant to any contractual arrangement that provides for the forfeiture of the transferor's securities in connection with the termination of the transferor's employment or other service relationship with the Company or an affiliated entity or the transferor's failure to meet certain conditions set out upon receipt of such securities; or

(j) in connection with the exercise of options, settlement of restricted stock units or other equity awards or exercise of warrants or other derivative securities, including (A) to satisfy tax withholding obligations in connection with the exercise of any such Equity Interests and (B) in payment on a "net exercise" or "cashless" basis of the exercise or purchase price with respect to the exercise of any such Equity Interests; provided, that any Equity Interests received upon such exercise, vesting or settlement shall be subject to the applicable terms of this Paragraph 4.

provided, however, that (A) in the case of any Transfer pursuant to any of the foregoing clauses (b), (c), (d), (e), and (g), such Transfer does not involve a disposition for value; (B) in the case of any Transfer pursuant to any of the foregoing clauses (a) through (i), (1) the Person effecting such Transfer provides written notice of such Transfer to the Company at least two Business Days prior to effecting such Transfer, (2) the Covered Shares so Transferred will remain subject to this Agreement, and before such Transfer will be considered effective, each transferee will enter into a written agreement with the Acquiror and the Company, in form and substance reasonably satisfactory to the Company, agreeing to be bound by the restrictions, and subject to the obligations, in this Agreement and the lock-up agreement, to be entered into in connection with the Closing, a substantially agreed form of which is attached as Exhibit C to the Merger Agreement (the "Lock-Up Agreement"), and (C) there will be no voluntary public disclosure or other voluntary announcement of such Transfer without the prior written consent of the Acquiror. Any Transfer in violation of the provisions of this Paragraph 4 shall be null and void *ab initio* and of no force or effect. Notwithstanding anything to the contrary in this Paragraph 4, this Agreement shall not prohibit the Company Preferred Conversion and the Company Warrant Exercise, in accordance with their terms prior to the Effective Time of the Merger.

5. Other Covenants. Each Company Stockholder that is a party thereto hereby agrees that it shall deliver at the Closing to the Company and Acquiror a duly executed counterpart to (A) the Lock-Up Agreement, and (B) the amended and restated registration rights agreement to be entered into in connection with the Closing, a substantially agreed form of which is attached as Exhibit D to the Merger Agreement (the "Registration Rights Agreement").

6. Definitions. As used herein, the following terms shall have the respective meanings set forth below. Capitalized terms used but not defined herein shall have the meanings given to them in the Merger Agreement.

(a) "Permitted Transferee" means each transferee contemplated by clauses (a) through (j) of Paragraph 4.

(b) "Representative" means, with respect to any specified Person, any director, manager, officer, employee, agent, attorney, advisor or other representative of such specified Person.

(c) “Transfer” means the (i) sale of, offer to sell, contract or agreement to sell, hypothecate, pledge, hedge, grant of any option to purchase or otherwise dispose of in any manner (including by merger, consolidation, division, operation of law or otherwise) or agreement to dispose of, directly or indirectly, or establishment or increase of a put equivalent position or liquidation with respect to or decrease of a call equivalent position within the meaning of Section 16 of the Exchange Act and the rules and regulations of the SEC promulgated thereunder with respect to, any security (including, for the avoidance of doubt, through a Transfer of equity securities in a Person who owns such security) or (ii) entry into any swap or other arrangement that transfers to another, in whole or in part, any of the economic consequences of ownership of any security, whether any such transaction is to be settled by delivery of such securities, in cash or otherwise.

7. Entire Agreement; Amendment; No Reliance. This Agreement, the Merger Agreement and the other Ancillary Agreements constitute the entire agreement and understanding of the parties hereto in respect of the subject matter hereof and supersede all prior understandings, agreements, or representations by or among the parties hereto, written or oral, to the extent they relate in any way to the subject matter hereof or the transactions contemplated hereby. This Agreement may not be changed, amended, modified or waived (other than to correct a typographical error) as to any particular provision, except by a written instrument executed by the parties hereto and any Permitted Transferee. Each Company Stockholder hereby acknowledges and agrees, on behalf of itself, its Affiliates and its Representatives, that, in connection with its entry into this Agreement and (if applicable) the Merger Agreement, the Ancillary Agreements and agreement to consummate the Transactions, none of the foregoing has relied on any representations or warranties of the Company or Acquiror except for those expressly set forth herein.

8. Assignment. No Company Stockholder party hereto may, except as set forth herein, assign either this Agreement or any of its rights, interests, or obligations hereunder without the prior written consent of the Company and Acquiror; provided, that no such assignment or delegation shall relieve any Company Stockholder of its obligations hereunder. The Company and Acquiror may not assign this agreement or any of its or their rights, interests, or obligations hereunder without the prior written consent of the other parties. Any purported assignment in violation of this Paragraph 8 shall be void and ineffectual and shall not operate to transfer or assign any interest or title to the purported assignee. This Agreement shall be binding on the parties hereto and their respective successors, heirs, personal representatives, permitted assigns and, in the case of the Company Stockholders, Permitted Transferees.

9. No Third-Party Beneficiaries; No Ownership Interests. Nothing in this Agreement shall be construed to confer upon, or give to, any Person (other than the parties and their successors, heirs, personal representatives, permitted assigns and, in the case of the Company Stockholders, Permitted Transferees) hereto any right, remedy or claim under or by reason of this Agreement or of any covenant, condition, stipulation, promise or agreement hereof. All covenants, conditions, stipulations, promises and agreements contained in this Agreement shall be for the sole and exclusive benefit of the parties hereto, and their respective successors, heirs, personal representatives, permitted assigns and, in the case of the Company Stockholders, Permitted Transferees. Nothing contained in this Agreement shall be deemed to vest in Acquiror any direct or indirect ownership or incidents of ownership of or with respect to the Company Stockholder's Covered Shares. All rights, ownership and economic benefits of and relating to the Company Stockholder's shall remain vested in and belong to such Company Stockholder, and Acquiror shall have no authority to manage, direct, restrict, regulate, govern or administer any of the policies or operations of Company or exercise any power or authority to direct any Company Stockholder in the voting or disposition of any of such Company Stockholder's Covered Shares, except as otherwise provided herein.

10. Captions; Counterparts. The headings and captions in this Agreement are for convenience of reference only and shall not be considered a part of, modify or affect the construction or interpretation of any provision of this Agreement. This Agreement may be executed in two or more counterparts, each of which shall be deemed an original, but all of which together shall constitute one and the same instrument.

11. Severability. This Agreement shall be deemed severable, and the invalidity or unenforceability of any term or provision hereof shall not affect the validity or enforceability of this Agreement or of any other term or provision hereof. Furthermore, in lieu of any such invalid or unenforceable term or provision, the parties hereto intend that there shall be added as a part of this Agreement a provision as similar in terms to such invalid or unenforceable provision as may be possible and be valid and enforceable.

12. Governing Law; Jurisdiction; Waiver of Jury Trial; Enforcement. Section 11.13 (*Jurisdiction; Waiver of Jury Trial*) and Section 11.14 (*Enforcement*) of the Merger Agreement are incorporated herein by reference, *mutatis mutandis*.

13. Notices. Any notice, consent or request to be given in connection with any of the terms or provisions of this Agreement shall be in writing and shall be sent or given in accordance with the terms of Section 11.3 (*Notices*) of the Merger Agreement to the Company Stockholder at the address listed beside the Company Stockholder's signature below.

14. Termination. This Agreement shall terminate, and no party shall have any further obligations or liabilities under this Agreement, (a) upon the valid termination of the Merger Agreement; (b) the effective time of the Merger; (c) upon the amendment, waiver, or modification of any term of the Merger Agreement, or the granting of consent thereunder, that is materially adverse to the interests of the undersigned Company Stockholder without such Company Stockholder's prior written consent; or (d) as mutually agreed in writing by the parties to this Agreement; provided, that no such termination shall relieve any party hereto from any liability resulting from its pre-termination willful breach of this Agreement.

15. Representations and Warranties. Each Company Stockholder hereby represents and warrants (severally and not jointly) to Acquiror and the Company as to itself (and not to any other Company Stockholder) as follows:

(a) if such Person is not an individual, it is duly organized, validly existing and in good standing under the laws of the jurisdiction in which it is incorporated, formed, organized or constituted, and the execution, delivery and performance of this Agreement and the consummation of the transactions contemplated hereby are within such Person's corporate, limited liability company or other organizational powers and have been duly authorized by all necessary corporate, limited liability company or other organizational actions on the part of such Person;

(b) if such Person is an individual, such Person has full legal capacity, right and authority to execute and deliver this Agreement and to perform its obligations hereunder;

(c) this Agreement has been duly executed and delivered by such Person and, assuming due authorization, execution and delivery by the other parties to this Agreement, this Agreement constitutes a legally valid and binding obligation of such Person, enforceable against such Person in accordance with the terms hereof (except as enforceability may be limited by bankruptcy Laws, other similar Laws affecting creditors' rights and general principles of equity affecting the availability of specific performance and other equitable remedies);

(d) the execution and delivery of this Agreement by such Person do not, and the performance by such Person of its obligations hereunder will not, (A) if such Person is not an individual, conflict with or result in a violation of the organizational documents of such Person, or (B) require any consent, waiver or approval that has not been given or other action that has not been taken by any third party (including under any Contract binding upon such Person or such Person's Covered Shares), in each case, to the extent such consent, waiver or approval or other action (or omission of which action) would prevent, enjoin or delay the performance by such Person of its obligations under this Agreement;

(e) there is no Action pending or, to the knowledge of such Person, threatened against such Person before (or, in the case of a threatened Action, that would be before) any arbitrator or any Governmental Authority, which in any manner challenges all or any part of this Agreement or any of the transactions contemplated hereby or seeks to, or would reasonably be expected to, prevent, enjoin or delay the performance by such Person of its obligations under this Agreement;

(f) no investment banker, broker, finder or other intermediary is entitled to any broker's, finder's, financial advisor's or other similar fee or commission for which Acquiror or the Company is or will be liable in connection with the transactions contemplated hereby based upon arrangements made by or, to the knowledge of the Company Stockholder, on behalf of the Company Stockholder;

(g) such Person has had the opportunity to read the Merger Agreement and this Agreement and has had the opportunity to consult with its tax, legal and other advisors and such Person is a sophisticated investor and has adequate information concerning the business and financial condition of Acquiror and the Company to make an informed decision regarding this Agreement and the transactions contemplated hereby and has independently and without reliance upon Acquiror, Merger Sub, the Company, or the Stockholder Representative and based on such information as such Person has deemed appropriate, made its own analysis and decision to enter into this Agreement. Such Person acknowledges that Acquiror, Merger Sub, the Company, and the Stockholder Representative have not made and do not make any representation or warranty, whether express or implied, of any kind or character except as expressly set forth in this Agreement. Such Person acknowledges that the agreements contained herein with respect to the Covered Shares held by such Person are irrevocable;

(h) such Person has not entered into, and will not enter into, any agreement that would restrict, limit or interfere with the performance of such Person's obligations hereunder;

(i) such Person has good and valid title to the number of Covered Shares set forth opposite such Person's name in the columns titled "Company Common Stock," "Company Preferred Stock," "Company Options" and "Company Warrants" in Schedule A hereto, and there exist no Lien or any other limitation or restriction (including, without limitation, any restriction on the right to vote, sell or otherwise dispose of such securities other than transfer restrictions under the U.S. Securities Act of 1933, as amended, and the rules and regulations promulgated thereunder) affecting any such securities, other than pursuant to (A) this Agreement, (B) the Bylaws of the Company, as amended from time to time (C) the Seventeenth Amended and Restated Certificate of Incorporation of the Company, dated May 23, 2022, as amended by the Certificate of Correction dated May 25, 2022, (D) the Eleventh Amended and Restated Investor's Rights Agreement, dated May 23, 2022, between the Company and the parties listed on Exhibit A thereto, (E) the Eleventh Amended and Restated Right of First Refusal and Co-Sale Agreement, dated May 23, 2022, by and among the Company and the parties listed on Exhibit A and Exhibit B thereto, (F) the Twelfth Amended and Restated Voting Agreement, dated May 23, 2022, by and among the Company and the parties listed on Exhibit A and Exhibit B thereto, (G) the Merger Agreement, (H) the Lock-Up Agreement, or (I) any applicable securities Laws;

(j) the shares of Company Common Stock, shares of Company Preferred Stock, Company Options and Company Warrants listed on Schedule A are the only equity securities in the Company (including, without limitation, any equity securities convertible into, or which can be exercised or exchanged for, equity securities of Acquiror) owned of record or beneficially by such Person as of the date hereof and as of immediately prior to the consummation of the Transactions on the Closing Date and such Person (or such Person's general partner or managing member) has the sole power to dispose of (or sole power to cause the disposition of) and the sole power to vote (or sole power to direct the voting of) such Equity Interests and none of such Equity Interests is subject to any proxy, voting trust or other agreement or arrangement with respect to the voting of such Equity Interests, except as provided in this Agreement; and

(k) such Person is not currently (and at all times through Closing will refrain from being or becoming) a member of a "group" (within the meaning of Section 13(d)(3) or Section 14(d)(2) of the Exchange Act, or any successor provision), including any group acting for the purpose of acquiring, holding or disposing of equity securities of Acquiror (within the meaning of Rule 13d-5(b)(1) under the Exchange Act).

16. Equitable Adjustments. If, and as often as, there are any changes in the Company Common Stock, Company Preferred Stock, Company Options or Company Warrants by way of stock split, stock dividend, combination or reclassification, or through merger, consolidation, reorganization, recapitalization or business combination, or by any other means, equitable adjustment shall be made to the provisions of this Agreement, as may be required, so that the rights, privileges, duties and obligations hereunder shall continue with respect to the Company Common Stock, Company Preferred Stock, Company Options or Company Warrants, each as so changed; provided, however, that this Paragraph 16 shall not (a) be construed to permit any Company Stockholder to take any action with respect to their respective securities that is prohibited by the terms and conditions of this Agreement or (b) apply to any other transactions expressly contemplated by this Agreement, the Merger Agreement, or any Ancillary Agreement to the extent consummated in accordance with the terms contemplated by this Agreement, the Merger Agreement and/or such Ancillary Agreement, as applicable.

17. Interpretation. Section 1.2 (*Construction*) and Section 11.6 (*Expenses*) of the Merger Agreement are incorporated herein by reference, *mutatis mutandis*. Wherever this Agreement uses “it”, “its” or derivations thereof to refer to a natural person or Company Stockholder, such references shall be deemed references to “her”, “him” or “his”, as applicable.

18. Updates to Schedule A. During the Interim Period, each Company Stockholder shall promptly notify the Company of any increase, decrease or other change in the number of shares of Company Common Stock, shares of Company Preferred Stock, Company Options or Company Warrants or other Covered Shares held by or on behalf of such Company Stockholder (for the avoidance of doubt, such Company Stockholder acknowledges and agrees that Paragraph 4 prohibits all Transfers of its Covered Shares during the Interim Period except to Permitted Transferees). Promptly following each such notification, the Company shall update, or cause to be updated, Schedule A to reflect the applicable changes as they relate to shares of Company Common Stock, shares of Company Preferred Stock, Company Options or Company Warrants (in the case of an Interim Period change) or other Covered Shares, and such updated Schedule A shall control for all purposes of this Agreement (unless and until it is later updated in accordance with this Paragraph 18). Any update to Schedule A in accordance with this Agreement shall not be deemed an amendment to this Agreement for purposes of Paragraph 7.

19. Further Assurances. Each of the parties hereto agrees to execute and deliver hereafter any further document, agreement or instrument of assignment, transfer or conveyance as may be necessary or desirable to effectuate the purposes hereof and as may be reasonably requested in writing by another party hereto. Notwithstanding anything herein to the contrary, nothing in this Agreement shall limit or restrict the ability of each Company Stockholder to enforce its rights under this Agreement or any other Ancillary Agreement to which such Company Stockholder is a party or seek any other remedies with respect to any breach of this Agreement or such other Ancillary Agreement by any other party hereto or thereto, including by commencing any Action in connection therewith.

20. Disclosure. Each Company Stockholder hereby authorizes each of the Company and Acquiror to publish and disclose, in any announcement, filing or disclosure required to be made by any Governmental Order or other applicable Law or the rules of any national securities exchange or as requested by the SEC, each Company Stockholder’s identity and ownership of Covered Shares and each Company Stockholder’s obligations under this Agreement.

21. Acknowledgement. Each Company Stockholder understands and acknowledges that the Company's and Acquiror's willingness to enter into the Merger Agreement was conditioned upon and materially induced by each Company Stockholder's execution and delivery of this Agreement and performance of its obligations hereunder.

22. No Agreement as Director or Officer. Notwithstanding any provision of this Agreement to the contrary, each Company Stockholder is signing this Agreement solely in its capacity as a shareholder of the Company. No Company Stockholder makes any agreement or understanding in this Agreement in such Company Stockholder's capacity (or in the capacity of any Affiliate, partner, manager, director, officer, member, equityholder or employee ("Related Parties") of such Company Stockholder) as a director, officer or employee of the Company or any of its Subsidiaries (if such Company Stockholder holds such office or position) or in any Company Stockholder's capacity (or in the capacity of any Affiliate, partner, manager, director, officer, member, equityholder or employee of such Company Stockholder) as a trustee or fiduciary of any employee benefit plan or trust. Nothing in this Agreement will limit or affect any actions or omissions taken by a Company Stockholder in his or her capacity as a director or officer of the Company or any of its Subsidiaries, and no actions or omissions taken in any Company Stockholder's capacity as a director or officer shall be deemed a breach of this Agreement. Nothing in this Agreement will be construed to prohibit, limit or restrict a Company Stockholder from exercising his or her fiduciary duties as an officer or director to the Company or its equityholders. No Company Stockholder shall be responsible for the actions of the Company or the Board of Directors of the Company (or any committee thereof), any Subsidiary of the Company, or any officers, directors (in their capacity as such), employees and professional advisors of any of the foregoing and such Company Stockholder makes no representations or warranties with respect to the actions of any of the foregoing.

23. Non-Recourse. Each party to this Agreement agrees, on behalf of itself and its Related Parties, that all actions (whether in contract or in tort, in law or in equity or otherwise, or granted by statute or otherwise, whether by or through attempted piercing of the corporate, limited partnership or limited liability company veil or any other theory or doctrine, including alter ego or otherwise) that may be based upon, in respect of, arise under, out or by reason of, be connected with, or relate in any manner to: (a) this Agreement; (b) the negotiation, execution or performance of this Agreement; (c) any breach or violation of this Agreement; and (d) any failure of any of the transactions contemplated by the Merger Agreement to be consummated, in each case, may be made only against (and are those solely of) the Persons that are expressly identified as parties to this Agreement and in accordance with, and subject to the terms and conditions of, this Agreement. Notwithstanding anything in this Agreement, each party to this Agreement agrees, on behalf of itself and its Related Parties, that no recourse under this Agreement or in connection with any of the transactions contemplated by the Merger Agreement will be sought or had against any other Person, including any Related Party, and no other Person, including any Related Party, will have any liabilities (whether in contract or in tort, in law or in equity or otherwise, or granted by statute or otherwise, whether by or through attempted piercing of the corporate, limited partnership or limited liability company veil or any other theory or doctrine, including alter ego or otherwise), for any claims, causes of action or liabilities arising under, out of, in connection with or related in any manner to the items in the immediately preceding clauses (a) through (d), it being expressly agreed and acknowledged that no personal liability or losses whatsoever will attach to, be imposed on or otherwise be incurred by any of the aforementioned, as such, arising under, out of, in connection with or related in any manner to the items in the immediately preceding clauses (a) through (d), in each case, except for claims that any Company Stockholder or Acquiror, as applicable, may assert against the other Company Stockholder or Acquiror, as applicable, solely in accordance with, and pursuant to the terms and conditions of, this Agreement. Notwithstanding anything to the contrary in this Agreement, no Related Party will be responsible or liable for any multiple, consequential, indirect, special, statutory, exemplary or punitive damages that may be alleged as a result of this Agreement or any of the transactions contemplated by the Merger Agreement, or the termination or abandonment of any of the foregoing.

24. Several and Not Joint Obligations. The representations, warranties, covenants, agreements, obligations and liability of the Company Stockholders party to this Agreement shall be several, and not joint. Notwithstanding any other provision of this Agreement, in no event will any Company Stockholder be liable for any other Person's breach of such other Person's representations, warranties, covenants, or agreements contained in this Agreement, the Merger Agreement or any other Ancillary Agreement.

[Signature Pages Follows]

IN WITNESS WHEREOF, the parties hereto have executed this Agreement on the day and year first above written.

COMPANY STOCKHOLDERS:

ALON VENTURES, LLC

By: _____
Name:
Title:

Address
Attention:
Email:

[Signature Page to Company Holders Support Agreement]

By:

Name:
Title:

Address
Attention:
Email:

[Signature Page to Company Holders Support Agreement]

ENERGY GROWTH MOMENTUM II LP

By: _____
Name:
Title:

Address
Attention:
Email:

[Signature Page to Company Holders Support Agreement]

CLAL INDUSTRIES LTD.

By: _____
Name:
Title:

Address
Attention:
Email:

[Signature Page to Company Holders Support Agreement]

TIGO SPV LP

By:

Name:
Title:

Address
Attention:
Email:

[Signature Page to Company Holders Support Agreement]

IN WITNESS WHEREOF, the parties hereto have executed this Agreement on the day and year first above written.

ACQUIROR:

ROTH CH ACQUISITION IV CO.

By: _____
Name:
Title:

[Signature Page to Company Holders Support Agreement]

IN WITNESS WHEREOF, the parties hereto have executed this Agreement on the day and year first above written.

COMPANY:

TIGO ENERGY, INC.

By: _____
Name:
Title:

[Signature Page to Company Holders Support Agreement]

**FORM OF
AMENDED AND RESTATED REGISTRATION RIGHTS AGREEMENT**

THIS AMENDED AND RESTATED REGISTRATION RIGHTS AGREEMENT (this "Agreement"), dated as of [●], is made and entered into by and among Tigo Energy, Inc. (formerly known as Roth CH Acquisition IV Co. ("SPAC")), a Delaware corporation (the "Company"), CHLM Sponsor LLC, a Delaware limited liability company ("CHLM"), CR Financial Holdings, Inc., a New York company ("CRFH") and, together with CHLM, the "Sponsors"), and each of the undersigned parties listed under Holder on the signature pages hereto (each such party, together with the Sponsors and any person or entity who hereafter becomes a party to this Agreement pursuant to Section 5.2 of this Agreement, a "Holder" and collectively the "Holders").

RECITALS

WHEREAS, on August 5, 2021, SPAC, the Sponsors, and the other holders party thereto (each such party, together with the Sponsors, the "Existing Holders") entered into that certain Registration Rights Agreement (the "Existing Registration Rights Agreement"), pursuant to which SPAC granted the Existing Holders certain registration rights with respect to certain securities of SPAC held by the Existing Holders;

WHEREAS, SPAC entered into that certain Agreement and Plan of Merger, dated as of December [●], 2022 (the "Merger Agreement"), by and among SPAC, Roth IV Merger Sub Inc., a Delaware corporation and wholly-owned subsidiary of SPAC ("Merger Sub"), and Tigo Energy, Inc., a Delaware corporation ("Tigo");

WHEREAS, pursuant to the Merger Agreement, upon the consummation ("Closing") of the merger of Merger Sub with and into Tigo (the "Merger"), the outstanding equity of Tigo was converted into that number of shares of common stock, par value \$0.0001 per share ("Common Stock"), of the Company as set forth in the Merger Agreement (the "Closing Shares");

WHEREAS, Sponsors and Tigo entered into that certain Sale and Purchase Agreement, dated as of [●], 2022, pursuant to which, on or about the date hereof, among other things: Sponsors sold an aggregate of 1,645,000 Founder Shares (as defined below) and 424,000 Private Units (as defined below) to Tigo;

WHEREAS, SPAC entered into that Termination Letter Agreement, dated as of [●], 2022, by and among SPAC, Roth Capital Partners, LLC, and Craig-Hallum Capital Group LLC, pursuant to which, on or about the date hereof, in consideration for the termination of the business combination marketing agreement with Acquiror, dated as of August 5, 2021, among other things, SPAC issued [●] shares of Common Stock to Roth Capital Partners, LLC (the "Advisor Shares");

WHEREAS, pursuant to Section 6.7 of the Existing Registration Rights Agreement, the provisions, covenants and conditions set forth therein may be amended or modified upon the written consent of SPAC and by the holders of the majority of "Registrable Securities" (as such term was defined in the Existing Registration Rights Agreement); and

WHEREAS, the Company and the Existing Holders desire to amend and restate the Existing Registration Rights Agreement, in order to provide the Holders certain registration rights with respect to the Registrable Securities (as defined below) on the terms set forth herein.

NOW, THEREFORE, in consideration of the representations, covenants and agreements contained herein, and certain other good and valuable consideration, the receipt and sufficiency of which are hereby acknowledged, the parties hereto, intending to be legally bound, hereby agree as follows:

**ARTICLE I
DEFINITIONS**

1.1 Definitions. Capitalized terms defined in this Section 1.1 shall, for all purposes of this Agreement, have the respective meanings set forth below:

"Adverse Disclosure" shall mean any public disclosure of material non-public information, which disclosure, in the good faith judgment of the Chief Executive Officer or Chief Financial Officer of the Company, after consultation with counsel to the Company, (i) would be required to be made in any Registration Statement or Prospectus in order for the applicable Registration Statement or Prospectus not to contain any Misstatement, (ii) would not be required to be made at such time if the Registration Statement were not being filed, declared effective or used, as the case may be, and (iii) the Company has a bona fide business purpose for not making such information public.

“Advisor Shares” shall have the meaning given in the Recitals hereto.

“Agreement” shall have the meaning given in the Preamble hereto.

“Block Trade” shall mean an offering and/or sale of Registrable Securities by any Holder on a coordinated or underwritten basis commonly known as a “block trade” (whether firm commitment or otherwise) without substantial marketing efforts prior to pricing, including, without limitation, a same day trade, overnight trade or similar transaction, but excluding a variable price reoffer.

“Board” shall mean the Board of Directors of the Company.

“Business Day” shall mean any day, other than a Saturday or a Sunday, that is neither a legal holiday nor a day on which banking institutions are generally authorized or required by law or regulation to close in the City of New York.

“CHLM” shall have the meaning given in the Preamble hereto.

“Closing” shall have the meaning given in the Recitals hereto.

“Closing Shares” shall have the meaning given in the Recitals hereto.

“Commission” shall mean the Securities and Exchange Commission.

“Commission Guidance” shall mean (i) any publicly-available guidance of the Commission staff, or any comments, requirements, or requests of the Commission staff and (ii) the Securities Act and the rules and regulations thereunder.

“Common Stock” shall have the meaning given in the Recitals hereto.

“Company” shall have the meaning given in the Preamble hereto, and includes the Company’s successors by recapitalization, merger, consolidation, spin-off, reorganization or similar transaction.

“CRFH” shall have the meaning given in the Preamble hereto.

“Demanding Holder” shall have the meaning given in [subsection 2.1.4](#).

“EDGAR” shall have the meaning set forth in [subsection 3.1.3](#).

“Effectiveness Deadline” shall have the meaning given in [subsection 2.1.1](#).

“Exchange Act” shall mean the Securities Exchange Act of 1934, as it may be amended from time to time.

“Existing Holder” shall have the meaning given in the Recitals hereto.

“Existing Registration Rights Agreement” shall have the meaning given in the Recitals hereto.

“Form S-1 Shelf” shall have the meaning given in [subsection 2.1.1](#).

“Form S-3 Shelf” shall have the meaning given in [subsection 2.1.2](#).

“Founder Shares” shall mean the shares of common stock, par value \$0.0001 per share, of SPAC issued to the Sponsors and certain other stockholders prior to SPAC’s initial public offering.

“Holder” shall have the meaning given in the Preamble hereto for so long as such Person holds any Registrable Securities.

“Lock-Up Agreement” shall mean that certain Lock-up Agreement, dated as of [●], by and among the Company, each holder of Founder Shares and certain stockholders of Tigo.

“Lock-Up Period” shall mean the lock-up period specified with respect to a party in the Lock-Up Agreement.

“Maximum Number of Securities” shall have the meaning given in [subsection 2.1.5](#).

“Merger” shall have the meaning given in the Recitals hereto.

“Merger Agreement” shall have the meaning given in the Recitals hereto.

“Merger Sub” shall have the meaning given in the Recitals hereto.

“Misstatement” shall mean an untrue statement of a material fact or an omission to state a material fact required to be stated in a Registration Statement or Prospectus, or necessary to make the statements in a Registration Statement or Prospectus (in the case of a Prospectus, in the light of the circumstances under which they were made) not misleading.

“Other Coordinated Offering” shall mean an “at the market” or similar registered offering through a broker, sales agent, or distribution agent, whether acting as agent or principal.

“Permitted Transferees” shall mean (x) a Person to whom a Holder of Registrable Securities is permitted to transfer such Registrable Securities prior to the expiration of the applicable Lock-up Period pursuant to the Lock-Up Agreement and (y) after expiration of the Lock-Up Period, a person or entity to whom a Holder of Registrable Securities is permitted to transfer such Registrable Securities under this Agreement, the Company’s bylaws and any other applicable agreement between such Holder and the Company, and to any transferee thereafter.

“Person” shall mean any individual, corporation, partnership, trust, limited liability company, association or other entity.

“Piggyback Registration” shall have the meaning given in subsection 2.2.1.

“Piggyback Registration Rights Holders” shall have the meaning given in subsection 2.2.1.

“Private Units” shall mean the units issued to the Sponsors in a private placement simultaneously with the closing of SPAC’s initial public offering.

“Private Warrants” shall mean a warrant entitling the holder to purchase one share of Common Stock at an exercise price of \$11.50 per share that was included in the Private Units

“Prospectus” shall mean the prospectus included in any Registration Statement, as supplemented by any and all prospectus supplements and as amended by any and all post-effective amendments and including all material incorporated by reference in such prospectus.

“Registrable Security” shall mean (a) the Founder Shares, (b) all shares of Common Stock issued to the equityholders of Tigo in the Merger, including the Closing Shares, (c) the Advisor Shares, (d) any outstanding shares of Common Stock, Warrants (as defined below), or any other equity security (including the shares of Common Stock issued or issuable upon the exercise of the Warrants or any other equity security) of the Company held by a Holder as of the date of this Agreement, and (e) any other equity security of the Company issued or issuable with respect to any such Common Stock by way of a stock dividend, stock split, share capitalization or share sub-division or in connection with a combination of shares, recapitalization, merger, consolidation, reorganization, or similar transaction; provided, however, that, as to any particular Registrable Security, such securities shall cease to be Registrable Securities upon the earliest to occur of: (i) a Registration Statement with respect to the sale of such securities shall have become effective under the Securities Act and such securities shall have been sold, transferred, disposed of or exchanged in accordance with such Registration Statement; (ii) such securities shall have been otherwise transferred, new certificates or book entry positions for such securities not bearing a legend restricting further transfer shall have been delivered by the Company and subsequent public distribution of such securities shall not require registration under the Securities Act, (iii) such securities shall have ceased to be outstanding; (iv) such securities have been sold to, or through, a broker, dealer or underwriter in a public distribution or other public securities transaction; or (v) with respect to a Holder, when all such securities held by such Holder could be sold in any three-month period without registration under Rule 144 promulgated under the Securities Act (or any successor rule promulgated thereafter by the Commission) without restriction on volume or manner of sale or other limitations or restrictions thereunder.

“Registration” shall mean a registration effected by preparing and filing a registration statement or similar document in compliance with the requirements of the Securities Act, and the applicable rules and regulations promulgated thereunder, and such registration statement becoming effective.

“Registration Expenses” shall mean the documented, out-of-pocket expenses of a Registration, excluding Selling Expenses, but including, without limitation, the following:

(A) all registration and filing fees (including fees with respect to filings required to be made with the Financial Industry Regulatory Authority, Inc.) and any national securities exchange on which the Common Stock is then listed;

(B) fees and expenses of compliance with securities or blue sky laws (including reasonable fees and disbursements of outside counsel for the Underwriters in connection with blue sky qualifications of Registrable Securities);

(C) printing, messenger, telephone and delivery expenses;

(D) reasonable and documented fees and disbursements of counsel for the Company;

(E) reasonable and documented fees and disbursements of all independent registered public accountants of the Company incurred specifically in connection with such Registration; and

(F) reasonable and documented fees and expenses of one (1) legal counsel selected by the majority-in-interest of the Demanding Holders initiating an Underwritten Shelf Takedown (the "Selling Holder Counsel") not to exceed \$50,000 in the aggregate without prior approval of the Company.

"Registration Statement" shall mean any registration statement under the Securities Act that covers the Registrable Securities pursuant to the provisions of this Agreement, including the Prospectus included in such registration statement, amendments (including post-effective amendments) and supplements to such registration statement, and all exhibits to and all material incorporated by reference in such registration statement.

"Requesting Holders" shall have the meaning given in subsection 2.1.5.

"Rule 415" shall mean Rule 415 promulgated under the Securities Act (or any successor rule then in effect).

"Securities Act" shall mean the Securities Act of 1933, as amended from time to time.

"Selling Expenses" shall mean all underwriting discounts, selling commissions, and stock transfer taxes applicable to the sale of Registrable Securities, and fees and disbursements of counsel for any Holder, except for the fees and disbursements of the Selling Holder Counsel borne and paid by the Company as provided in Section 3.2.

"Shelf Registration" shall mean a registration of securities pursuant to a Registration Statement filed with the Commission in accordance with Rule 415.

"Shelf Registration Statement" shall have the meaning given in subsection 2.1.1.

"Shelf Takedown Notice" shall have the meaning given in subsection 2.1.4.

"SPAC" shall have the meaning given in the Preamble hereto.

"Sponsor" shall have the meaning given in the Recitals hereto.

"Subsequent Shelf Registration Statement" shall have the meaning given in subsection 2.1.2.

"Tigo" shall have the meaning given in the Recitals hereto.

"Underwriter" shall mean a securities dealer who purchases any Registrable Securities as principal in an Underwritten Offering and not as part of such dealer's market-making activities.

"Underwritten Registration" or "Underwritten Offering" shall mean a Registration in which securities of the Company are sold to an Underwriter in a firm commitment underwriting for distribution to the public, including an offering and/or sale of Registrable Securities by any Holder in a block trade or on an underwritten basis (whether firm commitment or otherwise) without substantial marketing efforts prior to pricing, including, without limitation, a same day trade, overnight trade or similar transaction, but excluding a variable price reoffer.

"Underwritten Shelf Takedown" shall have the meaning given in subsection 2.1.4.

"Warrants" shall mean the warrants of the Company exercisable beginning 30 calendar days after the Closing for one share of Common Stock at an initial exercise price of \$11.50 per share, and shall include the Private Warrants.

"Withdrawal Notice" shall have the meaning given in subsection 2.1.6.

**ARTICLE II
REGISTRATIONS**

2.1 Shelf Registrations.

2.1.1 Initial Registration. The Company shall, as promptly as reasonably practicable, but in no event later than thirty (30) calendar days after the Closing Date, use its reasonable best efforts to file a Registration Statement under the Securities Act to permit the public resale of all the Registrable Securities held by the Holders (and certain other outstanding equity securities of the Company as may be required by registration rights granted in favor of other stockholders or in the Company's sole discretion) from time to time as permitted by Rule 415 (a "Shelf Registration Statement") on the terms and conditions specified in this subsection 2.1.1 and shall use its reasonable best efforts to cause such Shelf Registration Statement to be declared effective as soon as practicable after the initial filing thereof, but in no event later than the earlier of (a) sixty (60) days following the filing deadline (the "Effectiveness Deadline"), provided, that the Effectiveness Deadline shall be extended to ninety (90) days after the filing deadline if the Shelf Registration Statement is reviewed by, and the Company receives comments from, the Commission, and (b) the tenth (10th) Business Day after the date the Company is notified, orally or in writing, by the Commission that the Shelf Registration Statement will not be reviewed or will not be subject to further review. The Shelf Registration Statement filed with the Commission pursuant to this subsection 2.1.1 shall be filed on Form S-1 (a "Form S-1 Shelf") or such other form of registration statement as is then available to effect a registration for resale of such Registrable Securities, covering such Registrable Securities, and shall contain a Prospectus in such form as to permit any Holder to sell such Registrable Securities pursuant to Rule 415 at any time beginning on the effective date for such Shelf Registration Statement. A Shelf Registration Statement filed pursuant to this subsection 2.1.1 shall provide for the resale pursuant to any method or combination of methods legally available to, and requested prior to effectiveness by, the Holders, including the registration of the distribution to a Holder's shareholders, partners, members or other affiliates. The Company shall use its reasonable best efforts to cause a Shelf Registration Statement filed pursuant to this subsection 2.1.1 to remain effective, and to be supplemented and amended to the extent necessary to ensure that such Shelf Registration Statement is available or, if not available, that another Shelf Registration Statement is available, for the resale of all the Registrable Securities held by the Holders until all such Registrable Securities have ceased to be Registrable Securities. When effective, a Shelf Registration Statement filed pursuant to this subsection 2.1.1 (including the documents incorporated therein by reference) will comply as to form in all material respects with all applicable requirements of the Securities Act and the Exchange Act and will not contain any untrue statement of a material fact or omit to state a material fact required to be stated therein or necessary to make the statements therein not misleading (in the case of any Prospectus contained in such Shelf Registration Statement, in the light of the circumstances under which such statement is made). The Company's obligations under this subsection 2.1.1, shall, for the avoidance of doubt, be subject to Section 3.4.

2.1.2 Subsequent Registration Statement. If the Shelf Registration Statement required by subsection 2.1.1 ceases to be effective under the Securities Act for any reason at any time while Registrable Securities are still outstanding, the Company shall, subject to Section 3.4, use its commercially reasonable efforts to, as promptly as is reasonably practicable, cause such Shelf Registration Statement to again become effective under the Securities Act (including using its reasonable best efforts to obtain the prompt withdrawal of any order suspending the effectiveness of such Shelf Registration Statement), and shall use its reasonable best efforts to, as promptly as is reasonably practicable, amend such Shelf Registration Statement in a manner reasonably expected to result in the withdrawal of any order suspending the effectiveness of such Shelf Registration Statement or file an additional Registration Statement (a "Subsequent Shelf Registration Statement") registering the resale of all Registrable Securities (determined as of two (2) Business Days prior to such filing), and pursuant to any method or combination of methods legally available to, and requested by, any Holder named therein. If a Subsequent Shelf Registration Statement is filed, the Company shall use its reasonable best efforts to (i) cause such Subsequent Shelf Registration Statement to become effective under the Securities Act as promptly as is reasonably practicable after the filing thereof (it being agreed that the Subsequent Shelf Registration Statement shall be an automatic shelf registration statement (as defined in Rule 405 promulgated under the Securities Act) if the Company is a well-known seasoned issuer (as defined in Rule 405 promulgated under the Securities Act) at the most recent applicable eligibility determination date) and (ii) keep such Subsequent Shelf Registration Statement continuously effective, available for use to permit the Holders named therein to sell their Registrable Securities included therein and in compliance with the provisions of the Securities Act until such time as all such Registrable Securities included therein have ceased to be Registrable Securities. Any such Subsequent Shelf Registration Statement shall be on Form S-3 (a "Form S-3 Shelf") or any similar short-form registration statement that may be available at such time to the extent that the Company is eligible to use such form. Otherwise, such Subsequent Shelf Registration Statement shall be on another appropriate form. The Company's obligation under this subsection 2.1.2, shall, for the avoidance of doubt, be subject to Section 3.4.

2.1.3 Conversion to Form S-3. The Company shall use its commercially reasonable efforts to convert a Form S-1 Shelf into a Form S-3 Shelf as soon as practicable after the Company is eligible to use Form S-3. The Company's obligations under this subsection 2.1.3, shall, for the avoidance of doubt, be subject to Section 3.4.

2.1.4 Underwritten Shelf Takedown. At any time and from time to time following the effectiveness of the Shelf Registration Statement required by subsection 2.1.1 or 2.1.2, and following any applicable Lock-up Period, any Holder (being in such case, a "Demanding Holder") may request to sell all or a portion of their Registrable Securities in an Underwritten Offering that is registered pursuant to such shelf registration statement (an "Underwritten Shelf Takedown"), provided, that such Holder(s) (a) reasonably expect aggregate gross proceeds in excess of \$25,000,000 from such Underwritten Shelf Takedown or (b) reasonably expects to sell all of the Registrable Securities held by such Holder in such Underwritten Shelf Takedown but in no event less than \$10,000,000 in aggregate gross proceeds. All requests for an Underwritten Shelf Takedown shall be made by giving written notice to the Company (the "Shelf Takedown Notice"). Each Shelf Takedown Notice shall specify the approximate number of Registrable Securities proposed to be sold in the Underwritten Shelf Takedown, the expected price range (net of underwriting discounts and commissions) of such Underwritten Shelf Takedown and the proposed form of the Underwritten Shelf Takedown. Within three (3) Business Days after receipt of any Shelf Takedown Notice (or twenty-four (24) hours thereafter in connection with an underwritten block trade), the Company shall give written notice of such requested Underwritten Shelf Takedown to all other Holders of Registrable Securities (the "Company Shelf Takedown Notice") and, subject to reductions consistent with subsection 2.1.5, shall include in such Underwritten Shelf Takedown all Registrable Securities with respect to which the Company has received written requests for inclusion therein, within five (5) days after sending the Company Shelf Takedown Notice, or, in the case of a Block Trade, as provided in Section 2.3.1. The Company shall enter into an underwriting agreement in a form as is customary in Underwritten Offerings of securities by the Company with the managing Underwriter or Underwriters selected by the initiating Demanding Holders with the prior written consent of the Company (such consent not to be unreasonably withheld, conditioned, or delayed) and shall take all such other reasonable actions as are requested by the managing Underwriter or Underwriters in order to expedite or facilitate the disposition of such Registrable Securities. In connection with any Underwritten Shelf Takedown contemplated by this subsection 2.1.4, subject to Section 3.3 and ARTICLE IV, the underwriting agreement into which each Holder and the Company shall enter shall contain such representations, covenants, indemnities and other rights and obligations of the Company and the selling stockholders as are customary in underwritten offerings of securities. Under no circumstances shall the Company be obligated to effect (x) more than an aggregate of four (4) Underwritten Shelf Takedowns pursuant to a Shelf Takedown Notice by the Demanding Holders under this subsection 2.1.4 with respect to any or all Registrable Securities held by such Demanding Holders and (y) more than two (2) Underwritten Shelf Takedowns per year pursuant to this subsection 2.1.4; provided, however, that an Underwritten Shelf Takedown pursuant to a Shelf Takedown Notice shall not be counted for such purposes unless a Registration Statement that may be available at such time has become effective and all of the Registrable Securities requested by the Demanding Holders have been sold.

2.1.5 Reduction of Underwritten Shelf Takedown. If the managing Underwriter or Underwriters in an Underwritten Shelf Takedown, in good faith, advises the Company, the Demanding Holders and the Holders requesting piggy back rights pursuant to this Agreement with respect to such Underwritten Shelf Takedown (the "Requesting Holders") (if any) in writing that the dollar amount or number of shares of Registrable Securities that the Demanding Holders and the Requesting Holders (if any) desire to sell, taken together with all other shares of Common Stock or other equity securities that the Company desires to sell and all other shares of Common Stock or other equity securities, if any, as to which Registration has been requested pursuant to separate written contractual arrangements with Persons other than the Piggyback Registration Rights Holders hereunder, exceeds the maximum dollar amount or maximum number of equity securities that can be sold in the Underwritten Shelf Takedown without adversely affecting the proposed offering price, the timing, the distribution method, or the probability of success of such offering (such maximum dollar amount or maximum number of such securities, as applicable, the "Maximum Number of Securities"), then the Company shall include in such Underwritten Shelf Takedown, (i) first, before including any shares of Common Stock or other equity securities proposed to be sold by the Company or by other holders of Common Stock or other equity securities, the Registrable Securities of the Demanding Holders and the Requesting Holders (if any) (pro rata based on the respective number of Registrable Securities that each Demanding Holder and Requesting Holder (if any) has requested be included in such Underwritten Shelf Takedown and the aggregate number of Registrable Securities that the Demanding Holders and Requesting Holders have requested be included in such Underwritten Shelf Takedown) that can be sold without exceeding the Maximum Number of Securities, (ii) second, to the extent that the Maximum Number of Securities has not been reached under the foregoing clause (i), the shares of Common Stock or other equity securities that the Company desires to sell, which can be sold without exceeding the Maximum Number of Securities and (iii) third, to the extent that the Maximum Number of Securities has not been reached under the foregoing clauses (i) and (ii), the shares of Common Stock or other equity securities of other Persons that the Company is obligated to register in a Registration pursuant to separate written contractual arrangements with such Persons and that can be sold without exceeding the Maximum Number of Securities.

2.1.6 Withdrawal. Prior to the filing of the applicable “red herring” prospectus or prospectus supplement used for marketing such Underwritten Shelf Takedown, a majority-in-interest of the Demanding Holders initiating an Underwritten Shelf Takedown shall have the right to withdraw from such Underwritten Shelf Takedown for any or no reason whatsoever upon written notification (a “Withdrawal Notice”) to the Company and the Underwriter or Underwriters (if any) of their intention to withdraw from such Underwritten Shelf Takedown. Except as provided in Section 3.2, if an Underwritten Shelf Takedown is withdrawn pursuant to such request, the Demanding Holder shall reimburse the Company for all Registration Expenses with respect to such Underwritten Shelf Takedown (or, if there is more than one Demanding Holder, a pro rata portion of such Registration Expenses based on the respective number of Registrable Securities that each Demanding Holder has requested be included in such Underwritten Shelf Takedown); provided that, notwithstanding the foregoing, if the Demanding Holder(s) do not reimburse the Company for all Registration Expenses with respect to such Underwritten Shelf Takedown, the number of Underwritten Shelf Takedowns contemplated by Section 2.1.4 shall be correspondingly reduced. Following the receipt of any Withdrawal Notice, the Company shall promptly forward such Withdrawal Notice to any other Holders that had elected to participate in such Underwritten Shelf Takedown.

2.2 Piggyback Registration

Piggyback Rights. If the Company proposes to file a Registration Statement under the Securities Act with respect to an offering of equity securities, or securities or other obligations exercisable or exchangeable for, or convertible into equity securities, for its own account or for the account of stockholders of the Company (or by the Company and by the stockholders of the Company, including, without limitation, an Underwritten Shelf Takedown pursuant to subsection 2.1.4), other than a Registration Statement (i) filed in connection with any employee stock option or other benefit plan, (ii) pursuant to a Registration Statement on Form S-4 (or similar form that related to a transaction subject to Rule 145 promulgated under the Securities Act or any successor rule thereto), (iii) for a rights offering or an exchange offer or offering of securities solely to the Company’s existing stockholders, (iv) for an offering of debt that is convertible into equity securities of the Company, (v) for an “at the market” or similar registered offering through a broker, sales agent or distribution agent, whether as agent or principal, or (vi) for a dividend reinvestment plan, then the Company shall give written notice of such proposed filing to all of the Holders of Registrable Securities as soon as reasonably practicable but not less than five (5) Business Days before the anticipated filing date of such Registration Statement, which notice shall (A) describe the amount and type of securities to be included in such offering, the intended method(s) of distribution, and the name of the proposed managing Underwriter or Underwriters, if any, in such offering, and (B) offer to all of the Holders of Registrable Securities the opportunity to register the sale of such number of Registrable Securities as such Holders may request in writing within three (3) Business Days after the sending of such written notice (such Registration a “Piggyback Registration”, and each such Holder that includes all or a portion of such Holder’s Registrable Securities in such Piggyback Registration, the “Piggyback Registration Rights Holders”); provided, further, that the exercise of any piggy-back rights with respect to any block trade should be done no later than twenty four (24) hours following receipt of any written notice regarding such Block Trade. The Company shall, in good faith, cause such Registrable Securities to be included in such Piggyback Registration and, if applicable, shall use its reasonable best efforts to cause the managing Underwriter or Underwriters of a proposed Underwritten Offering to permit the Registrable Securities requested by the Piggyback Registration Rights Holders pursuant to this subsection 2.2.1 to be included therein on the same terms and conditions as any similar securities of the Company included in such Registration and to permit the sale or other disposition of such Registrable Securities in accordance with the intended method(s) of distribution thereof. All such Piggyback Registration Rights Holders proposing to distribute their Registrable Securities through an Underwritten Offering under this subsection 2.2.1 shall enter into an underwriting agreement in customary form with the Underwriter(s) selected for such Underwritten Offering by the Company. The notice periods set forth in this subsection 2.2.1 shall not apply to an Underwritten Shelf Takedown conducted in accordance with subsection 2.1.4. The Company shall have the right to terminate or withdraw any Registration Statement initiated by it under this subsection 2.2.1 before the effective date of such Registration, whether or not any Piggyback Registration Rights Holder has elected to include Registrable Securities in such Registration 2.1.4.

2.2.1 Reduction of Piggyback Registration. If the managing Underwriter or Underwriters in an Underwritten Registration that is to be a Piggyback Registration, in good faith, advises the Company and the Holders of Registrable Securities participating in the Piggyback Registration in writing that the dollar amount or number of shares of Common Stock or other equity securities that the Company desires to sell, taken together with (i) the shares of Common Stock or other equity securities, if any, as to which Registration has been demanded pursuant to separate written contractual arrangements with Persons other than the Holders of Registrable Securities hereunder, (ii) the Registrable Securities as to which registration has been requested pursuant to Section 2.2 hereof, and (iii) the shares of Common Stock or other equity securities, if any, as to which Registration has been requested pursuant to separate written contractual piggy-back registration rights of Persons other than the Holders of Registrable Securities hereunder, exceeds the Maximum Number of Securities, then:

(a) If the Registration is undertaken for the Company's account, the Company shall include in any such Registration (A) first, the shares of Common Stock or other equity securities that the Company desires to sell, which can be sold without exceeding the Maximum Number of Securities; (B) second, to the extent that the Maximum Number of Securities has not been reached under the foregoing clause (A), the Registrable Securities of Holders exercising their rights to register their Registrable Securities pursuant to subsection 2.2.1, pro rata, based on the respective number of Registrable Securities that each Holder has requested be included in such Underwritten Offering and the aggregate number of Registrable Securities that the Holders have requested to be included in such Underwritten Offering, which can be sold without exceeding the Maximum Number of Securities, which can be sold without exceeding the Maximum Number of Securities; and (C) third, to the extent that the Maximum Number of Securities has not been reached under the foregoing clauses (A) and (B), the shares of Common Stock or other equity securities, if any, as to which Registration has been requested or demanded pursuant to written contractual piggy-back registration rights of Persons other than the Holders of Registrable Securities hereunder, which can be sold without exceeding the Maximum Number of Securities.

(b) If the Registration is pursuant to a request by Persons other than the Holders of Registrable Securities, then the Company shall include in any such Registration (A) first, the shares of Common Stock or other equity securities, if any, of such requesting Persons, other than the Holders of Registrable Securities, which can be sold without exceeding the Maximum Number of Securities; (B) second, to the extent that the Maximum Number of Securities has not been reached under the foregoing clause (A), the Registrable Securities of Holders exercising their rights to register their Registrable Securities pursuant to subsection 2.2.1, pro rata, based on the respective number of Registrable Securities that each Holder has requested be included in such Underwritten Offering and the aggregate number of Registrable Securities that the Holders have requested to be included in such Underwritten Offering, which can be sold without exceeding the Maximum Number of Securities; (C) third, to the extent that the Maximum Number of Securities has not been reached under the foregoing clauses (A) and (B), the shares of Common Stock or other equity securities that the Company desires to sell, which can be sold without exceeding the Maximum Number of Securities; and (D) fourth, to the extent that the Maximum Number of Securities has not been reached under the foregoing clauses (A), (B) and (C), the shares of Common Stock or other equity securities for the account of other Persons that the Company is obligated to register pursuant to separate written contractual arrangements with such Persons, which can be sold without exceeding the Maximum Number of Securities.

(c) If the Underwritten Shelf Takedown is pursuant to a request by Holder(s) of Registrable Securities pursuant to subsection 2.1.4 hereof, then the Company shall include in any such Underwritten Shelf Takedown securities in the priority set forth in subsection 2.1.5.

2.2.2 Piggyback Registration Withdrawal. Any Holder of Registrable Securities (other than a Demanding Holder, whose right to withdraw from an Underwritten Shelf Takedown, and related obligations, shall be governed by subsection 2.1.6) shall have the right to withdraw from a Piggyback Registration for any or no reason whatsoever upon written notification to the Company and the Underwriter or Underwriters (if any) of his, her or its intention to withdraw from such Piggyback Registration prior to the effectiveness of the Registration Statement filed with the Commission with respect to such Piggyback Registration (or in the case of a Piggyback Registration pursuant to a Shelf Registration, at least five (5) Business Days prior to the time of pricing of the applicable offering). The Company (whether on its own good faith determination or as the result of a request for withdrawal by Persons pursuant to separate written contractual obligations) may withdraw a Registration Statement filed with the Commission in connection with a Piggyback Registration at any time prior to the effectiveness of such Registration Statement. Notwithstanding anything to the contrary in this Agreement (other than subsection 2.1.6), the Company shall be responsible for the Registration Expenses incurred in connection with the Piggyback Registration prior to its withdrawal under this subsection 2.2.3.

2.2.3 Unlimited Piggyback Registration Rights. Any Piggyback Registration effected pursuant to this Section 2.2 shall not be counted as a demand for an Underwritten Shelf Takedown under subsection 2.1.4.

2.3 Block Trades; Other Coordinated Offerings.

2.3.1 Notwithstanding any other provision of ARTICLE II, but subject to Section 3.4, at any time and from time to time when an effective Shelf Registration Statement is on file with the Commission, following any applicable Lock-up Period, if a Demanding Holder or Holders wishes to engage in Block Trade or Other Coordinated Offering, in each case with a total offering price reasonably expected to exceed, in the aggregate, either (x) \$25 million or (y) all remaining Registrable Securities held by the Demanding Holder or Holders, provided that the total offering price is reasonably expected to exceed \$10 million in the aggregate, such Demanding Holder(s) shall provide written notice to the Company at least five (5) Business Days prior to the date such Block Trade or Other Coordinated Offering will commence. As promptly as reasonably practicable the Company shall use its reasonable best efforts to facilitate such Block Trade or Other Coordinated Offering, provided that the Demanding Holder(s) use reasonable best efforts to work with the Company and the Underwriter(s) (including by disclosing the maximum number of Registrable Securities proposed to be the subject of such Block Trade or Other Coordinated Offering) in order to facilitate preparation of the Registration Statement, Prospectus and other offering documentation related to the Block Trade or Other Coordinated Offering and any related due diligence and comfort procedures.

2.3.2 Prior to the filing of the applicable "red herring" prospectus or prospectus supplement used in connection with a Block Trade or Other Coordinated Offering, a majority-in-interest of the Holders initiating such Block Trade or Other Coordinated Offering shall have the right to submit a Withdrawal Notice to the Company, the Underwriter or Underwriters (if any) and any brokers, sale agents or placement agents (if any) of their intention to withdraw from such Block Trade or Other Coordinated Offering. Notwithstanding anything to the contrary in this Agreement, the Company shall be responsible for the Registration Expenses incurred in connection with a Block Trade or Other Coordinated Offering prior to its withdrawal under this subsection 2.3.2.

2.3.3 [Reserved]

2.3.4 A majority-in-interest of the Demanding Holders in a Block Trade or Other Coordinated Offering shall have the right to select the Underwriters and any brokers, sale agents or placement agents (if any) for such Block Trade or Other Coordinated Offering (in each case, which shall consist of one or more reputable nationally recognized investment banks).

2.3.5 A Holder in the aggregate may demand no more than two (2) Block Trades or Other Coordinated Offerings pursuant to this Section 2.3 in any twelve (12) month period. For the avoidance of doubt, any Block Trade or Other Coordinated Offering effected pursuant to this Section 2.3 shall not be counted as a demand for an Underwritten Shelf Takedown pursuant to subsection 2.1.4 hereof.

**ARTICLE III
COMPANY PROCEDURES**

3.1 **General Procedures.** If the Company is required to effect the Registration of Registrable Securities, the Company shall use its reasonable best efforts to effect such Registration to permit the sale of such Registrable Securities in accordance with the intended plan of distribution thereof, and pursuant thereto the Company shall, as expeditiously as possible:

3.1.1 prepare and file with the Commission as soon as reasonably practicable a Registration Statement with respect to such Registrable Securities and use its reasonable best efforts to cause such Registration Statement to become effective and remain effective pursuant to the terms of this Agreement until all Registrable Securities covered by such Registration Statement have been sold;

3.1.2 prepare and file with the Commission such amendments and post-effective amendments to the Registration Statement, and such supplements to the Prospectus, as may be reasonably requested by the Holders or any Underwriter of Registrable Securities or as may be required by the rules, regulations or instructions applicable to the registration form used by the Company or by the Securities Act or rules and regulations thereunder to keep the Registration Statement effective until all Registrable Securities covered by such Registration Statement are sold in accordance with the intended plan of distribution set forth in such Registration Statement or supplement to the Prospectus or have ceased to be Registrable Securities;

3.1.3 with respect to an Underwritten Shelf Takedown, prior to filing a Registration Statement or Prospectus, or any amendment or supplement thereto, furnish without charge to the Underwriters, if any, and each Holder of Registrable Securities included in such Registration, and such Holder's legal counsel, copies of such Registration Statement as proposed to be filed, each amendment and supplement to such Registration Statement (in each case including all exhibits thereto and documents incorporated by reference therein), the Prospectus included in such Registration Statement (including each preliminary Prospectus), and such other documents as the Underwriters and each Holder of Registrable Securities included in such Registration or the legal counsel for any such Holders may reasonably request in order to facilitate the disposition of the Registrable Securities owned by such Holders;

3.1.4 prior to any Underwritten Offering of Registrable Securities, use its reasonable best efforts to (i) register or qualify the Registrable Securities covered by the Registration Statement under such securities or "blue sky" laws of such jurisdictions in the United States as the Holders of Registrable Securities included in such Registration Statement (in light of their intended plan of distribution) may reasonably request (or provide evidence reasonably satisfactory to such Holders that the Registrable Securities are exempt from such registration or qualification) and (ii) take such action necessary to cause such Registrable Securities covered by the Registration Statement to be registered with or approved by such other governmental authorities as may be necessary by virtue of the business and operations of the Company and do any and all other acts and things that may be necessary or advisable to enable any Holder of Registrable Securities included in such Registration Statement to consummate the disposition of such Registrable Securities in such jurisdictions; provided, however, that the Company shall not be required to qualify generally to do business or as a dealer in securities in any jurisdiction where it would not otherwise be required to qualify or take any action to which it would be subject to general service of process or taxation in any such jurisdiction where it is not then otherwise so subject;

3.1.5 cause all such Registrable Securities to be listed on each national securities exchange or automated quotation system on which similar securities issued by the Company are then listed;

3.1.6 provide a transfer agent or warrant agent, as applicable, and registrar for all such Registrable Securities no later than the effective date of such Registration Statement;

3.1.7 advise each seller of such Registrable Securities, promptly after it shall receive notice or obtain knowledge thereof, of the issuance of any stop order by the Commission suspending the effectiveness of such Registration Statement or the initiation or threatening of any proceeding for such purpose and promptly use its reasonable best efforts to prevent the issuance of any stop order or to obtain its withdrawal if such stop order should be issued;

3.1.8 at least three (3) days prior to the filing of any Registration Statement or Prospectus or any amendment or supplement to such Registration Statement or Prospectus (excluding post-effective amendments to update the Prospectus to include Exchange Act reports filed after the effective date of the Form S-1) furnish a copy of the Registration Statement and/or Prospectus, as applicable, to a seller of Registrable Securities named therein and its counsel upon request; provided, that the Company shall have no obligation to furnish any documents publicly filed or furnished with the Commission and publicly available pursuant to EDGAR;

3.1.9 notify the Holders at any time when a Prospectus relating to such Registration Statement is required to be delivered under the Securities Act, of the happening of any event as a result of which the Prospectus included in such Registration Statement, as then in effect, includes a Misstatement, and then to correct such Misstatement as set forth in Section 3.4 hereof;

3.1.10 in the event of an Underwritten Offering, a Block Trade, Other Coordinated Offering, or a sale by a broker, placement agent, or sales agent pursuant to such Registration Statement, in each of the foregoing cases solely to the extent customary for a transaction of its type, permit a representative of the Holders (such representative to be selected by a majority in interest of the participating Holders), the Underwriters, if any, and any attorney or accountant retained by such Holders or Underwriter to participate, at each such Person's own expense, in the preparation of the Registration Statement, and cause the Company's officers, directors and employees to supply all information reasonably requested by any such representative, Underwriter, attorney or accountant in connection with the Registration; provided, however, that any such representatives or Underwriters enter into a confidentiality agreement, in form and substance reasonably satisfactory to the Company, prior to the release or disclosure of any such information and provided, further, the Company may not include the name of any Holder or Underwriter or any information regarding any Holder or Underwriter in any Registration Statement or Prospectus, any amendment or supplement to such Registration Statement or Prospectus, any document that is to be incorporated by reference into such Registration Statement or Prospectus, or any response to any comment letter, without the prior written consent of such Holder or Underwriter and providing each such Holder or Underwriter a reasonable amount of time to review and comment on such applicable document, which comments the Company shall include unless contrary to applicable law;

3.1.11 obtain a "cold comfort" letter from the Company's independent registered public accountants in the event of an Underwritten Registration for the benefit of the Underwriters, in customary form and covering such matters of the type customarily covered by "cold comfort" letters for a transaction of its type as the managing Underwriter(s) may reasonably request;

3.1.12 on the date the Registrable Securities are delivered for sale pursuant to such Registration, in the event of an Underwritten Registration, obtain an opinion and negative assurance letter, dated such date, of counsel representing the Company for the purposes of such Registration, addressed to the Underwriters, the placement agent or sales agent, if any, covering such legal matters with respect to the Registration in respect of which such opinion is being given as the Underwriters, placement agent or sales agent may reasonably request and as are customarily included in such opinions and negative assurance letters, and reasonably satisfactory to such Underwriters, placement agent or sales agent;

3.1.13 in the event of any Underwritten Offering, enter into and perform its obligations under an underwriting agreement, in usual and customary form, with the managing Underwriter of such offering;

3.1.14 make available to its security holders, as soon as reasonably practicable, an earnings statement covering the period of at least twelve (12) months beginning with the first day of the Company's first full calendar quarter after the effective date of the Registration Statement which satisfies the provisions of Section 11(a) of the Securities Act and Rule 158 thereunder (or any successor rule promulgated thereafter by the Commission);

3.1.15 if the Registration involves the Registration of Registrable Securities involving gross proceeds in excess of \$25,000,000, use its reasonable best efforts to make available senior executives of the Company to participate in customary "road show" presentations that may be reasonably requested by the Underwriter in any Underwritten Offering; and

3.1.16 otherwise, in good faith, cooperate reasonably with, and take such customary actions as may reasonably be requested by the participating Holders, consistent with the terms of this Agreement, in connection with such Registration.

3.2 Registration Expenses. The Registration Expenses of all Registrations shall be borne by the Company; provided, however, that the Company shall not be required to pay for any expenses of any registration process begun pursuant to subsection 2.1.4 if the registration request is subsequently withdrawn at the request of the Demanding Holders (in which case the Demanding Holders shall bear such expenses pro rata based upon the number of Registrable Securities that were to be included in the withdrawn registration), unless if, at the time of such withdrawal, the Demanding Holders shall have learned of a material adverse change in the condition, business, or prospects of the Company not known (and not reasonably available upon request from the Company or otherwise) to the Demanding Holders at the time of their request and have withdrawn the request with reasonable promptness after learning of such information, then the Demanding Holders shall not be required to pay any of such expenses. It is acknowledged by the Holders that the Holders shall bear all Selling Expenses, other than as set forth in the definition of "Registration Expenses," and all reasonable fees and expenses of Selling Holder Counsel.

3.3 Requirements for Inclusion as a Selling Stockholder. Prior to the first anticipated filing date of a Registration Statement pursuant to this ARTICLE III, the Company shall use commercially reasonable efforts to notify each Holder in writing (which may be by email) of the information reasonably necessary about the Holder to include such Holder's Registrable Securities in such Registration Statement. Notwithstanding anything else in this Agreement, the Company shall not be obligated to include such Holder's Registrable Securities to the extent the Company has not received such information, and received any other reasonably requested agreements or certificates, on or prior to the fifth Business Day prior to the first anticipated filing date of a Registration Statement pursuant to this ARTICLE III. Further, no Person may participate in any Underwritten Offering for equity securities of the Company pursuant to a Registration initiated by the Company hereunder unless such Person (i) agrees to sell such Person's securities on the basis provided in any underwriting arrangements approved by the Company and (ii) completes and executes all customary questionnaires, powers of attorney, indemnities, lock-up agreements, underwriting agreements and other customary documents as may be reasonably required under the terms of such underwriting arrangements.

3.4 Suspension of Sales; Adverse Disclosure.

3.4.1 Upon receipt of written notice from the Company that a Registration Statement or Prospectus contains a Misstatement, or in the opinion of outside counsel for the Company it is necessary to supplement or amend such Prospectus to comply with applicable law, each of the Holders shall forthwith discontinue disposition of Registrable Securities until it has received copies of a supplemented or amended Prospectus correcting the Misstatement (it being understood that the Company hereby covenants to prepare and file such supplement or amendment as soon as practicable after the time of such notice), or until it is advised in writing by the Company that the use of the Prospectus may be resumed.

3.4.2 If the filing, initial effectiveness or continued use of a Registration Statement in respect of any Registration at any time (i) would require the Company to make an Adverse Disclosure, or (ii) would require the inclusion in such Registration Statement of financial statements that are unavailable to the Company for reasons beyond the Company's reasonable control, then the Company may, upon giving prompt written notice of such action to the Holders, delay the filing or initial effectiveness of, or suspend use of, such Registration Statement for the shortest period of time reasonably required as determined in good faith by the Company to be necessary for such purpose. In the event the Company exercises its rights under the preceding sentence, the Holders agree to suspend, immediately upon their receipt of the notice referred to above, their use of the Prospectus relating to any Registration in connection with any sale or offer to sell Registrable Securities until such Holder receives written notice from the Company that such sales or offers of Registrable Securities may be resumed, and in each case maintain the confidentiality of such notice and its contents. The Company shall immediately notify the Holders of the expiration of any period during which it exercised its rights under this Section 3.4. The right to delay or suspend pursuant to this subsection 3.4.2 shall be exercised by the Company, in the aggregate, for not more than sixty (60) consecutive calendar days or more than ninety (90) total calendar days in each case during any twelve (12)-month period.

3.4.3 During the period starting with the date sixty (60) calendar days prior to the Company's good faith estimate of the date of the filing of, and ending on a date one hundred twenty (120) calendar days (or such shorter time as the managing Underwriters may agree) after the effective date of, a Company-initiated Registration and provided that the Company continues to actively employ, in good faith, all reasonable efforts to maintain the effectiveness of the applicable Shelf Registration Statement, or if, pursuant to subsection 2.1.4, Holders have requested an Underwritten Shelf Takedown and the Company and Holders are unable to obtain the commitment of underwriters to firmly underwrite such offering, then the Company may, upon giving prompt written notice of such action to the Holders, delay any other registered offering pursuant to subsection 2.1.4 or Section 2.3 for the shortest period of time reasonably required as determined in good faith by the Company. The right to defer, delay or suspend any filing, initial effectiveness of a registered offering pursuant to this subsection 3.4.3 shall be exercised by the Company, in the aggregate, for not more than thirty (30) consecutive calendar days or more than sixty (60) total calendar days in each case during any twelve (12)-month period.

3.5 Reporting Obligations. As long as any Holder shall own Registrable Securities, the Company, at all times while it shall be a reporting company under the Exchange Act, shall file timely (or obtain extensions in respect thereof and file within the applicable grace period) all reports required to be filed by the Company after the date hereof pursuant to Sections 13(a) or 15(d) of the Exchange Act. The Company shall take such further action as any Holder may reasonably request, all to the extent required from time to time to enable such Holder to sell Registrable Securities held by such Holder without registration under the Securities Act within the limitation of the exemptions provided by Rule 144 promulgated under the Securities Act (or any successor rule promulgated thereafter by the Commission, to the extent that such rule or such successor rule is available to the Company), including providing any customary legal opinions. Upon the request of any Holder, the Company shall deliver to such Holder a written certification of a duly authorized officer as to whether it has complied with such requirements.

**ARTICLE IV
INDEMNIFICATION AND CONTRIBUTION**

4.1 Indemnification.

4.1.1 The Company agrees to indemnify, to the extent permitted by law, each such Holder of Registrable Securities, its officers and directors and each Person who controls such Holder (within the meaning of the Securities Act) against all losses, claims, damages, liabilities and reasonable and documented out-of-pocket expenses (including reasonable and documented outside attorneys' fees) caused by any untrue or alleged untrue statement of material fact contained in any Registration Statement, Prospectus or preliminary Prospectus or any amendment thereof or supplement thereto or any omission or alleged omission of a material fact required to be stated therein or necessary to make the statements therein not misleading, except insofar as the same are caused by or contained in any information furnished in writing to the Company by such Holder expressly for use therein. The Company shall indemnify the Underwriters, their officers and directors and each Person who controls such Underwriters (within the meaning of the Securities Act) to the same extent as provided in the foregoing with respect to the indemnification of the Holder.

4.1.2 In connection with any Registration Statement in which a Holder of Registrable Securities is participating, such Holder shall furnish to the Company in writing such information and affidavits as the Company reasonably requests for use in connection with any such Registration Statement or Prospectus and, to the extent permitted by law, shall indemnify the Company, its directors and officers and agents and each Person who controls the Company (within the meaning of the Securities Act) against any losses, claims, damages, liabilities and reasonable and documented out-of-pocket expenses (including without limitation reasonable and documented outside attorneys' fees) resulting from any untrue or alleged untrue statement of material fact contained, or incorporated by reference in accordance with the requirements of Form S-1 or Form S-3, in the Registration Statement, Prospectus or preliminary Prospectus or any amendment thereof or supplement thereto or any omission or alleged omission of a material fact required to be stated therein or necessary to make the statements therein not misleading, but only to the extent that such untrue statement or omission is contained in (or not contained in, in the case of an omission) any information or affidavit so furnished in writing by or on behalf of such Holder expressly for use therein; provided, however, that the obligation to indemnify shall be several, not joint and several, among such Holders of Registrable Securities, and the liability of each such Holder of Registrable Securities shall be in proportion to and limited to the net proceeds received by such Holder from the sale of Registrable Securities pursuant to such Registration Statement. The Holders of Registrable Securities shall indemnify the Underwriters, their officers, directors and each Person who controls such Underwriters (within the meaning of the Securities Act) to the same extent as provided in the foregoing with respect to indemnification of the Company.

4.1.3 Any Person entitled to indemnification herein shall (i) give prompt written notice to the indemnifying party of any claim with respect to which it seeks indemnification (provided, that the failure to give prompt notice shall not impair any Person's right to indemnification hereunder to the extent such failure has not materially prejudiced the indemnifying party's ability to defend such action) and (ii) unless in such indemnified party's reasonable judgment a conflict of interest between such indemnified and indemnifying parties may exist with respect to such claim, permit such indemnifying party to assume the defense of such claim with counsel reasonably satisfactory to the indemnified party. If such defense is assumed, the indemnifying party shall not be subject to any liability for any settlement made by the indemnified party without its consent (but such consent shall not be unreasonably withheld). An indemnifying party who is not entitled to, or elects not to, assume the defense of a claim shall not be obligated to pay the fees and expenses of more than one counsel for all parties indemnified by such indemnifying party with respect to such claim, unless in the reasonable judgment of any indemnified party a conflict of interest may exist between such indemnified party and any other of such indemnified parties with respect to such claim. No indemnifying party shall, without the consent of the indemnified party (such consent not to be unreasonably withheld), consent to the entry of any judgment or enter into any settlement which cannot be settled in all respects by the payment of money (and such money is so paid by the indemnifying party pursuant to the terms of such settlement), which settlement includes a statement or admission of fault or culpability on the part of such indemnified party, or which settlement does not include as an unconditional term thereof the giving by the claimant or plaintiff to such indemnified party of a release from all liability in respect to such claim or litigation.

4.1.4 The indemnification provided for under this Agreement shall remain in full force and effect regardless of any investigation made by or on behalf of the indemnified party or any officer, director or controlling Person of such indemnified party and shall survive the transfer of securities. The Company and each Holder of Registrable Securities participating in an offering also agrees to make such provisions as are reasonably requested by any indemnified party for contribution to such party in the event the Company's or such Holder's indemnification is unavailable for any reason.

4.1.5 If the indemnification provided under Section 4.1 hereof from the indemnifying party is unavailable or insufficient to hold harmless an indemnified party in respect of any losses, claims, damages, liabilities and documented out-of-pocket expenses referred to herein, then the indemnifying party, in lieu of indemnifying the indemnified party, shall contribute to the amount paid or payable by the indemnified party as a result of such losses, claims, damages, liabilities and documented out-of-pocket expenses in such proportion as is appropriate to reflect the relative fault of the indemnifying party and the indemnified party, as well as any other relevant equitable considerations. The relative fault of the indemnifying party and indemnified party shall be determined by reference to, among other things, whether any action in question, including any untrue or alleged untrue statement of a material fact or omission or alleged omission to state a material fact, was made by (or not made by, in the case of an omission), or relates to information supplied by (or not supplied by, in the case of an omission), such indemnifying party or indemnified party, and the indemnifying party's and indemnified party's relative intent, knowledge, access to information and opportunity to correct or prevent such action; provided, however, that the liability of any Holder under this subsection 4.1.5 shall be limited to the amount of the net proceeds received by such Holder in such offering giving rise to such liability. The amount paid or payable by a party as a result of the losses or other liabilities referred to above shall be deemed to include, subject to the limitations set forth in subsections 4.1.1, 4.1.2 and 4.1.3 above, any legal or other fees, charges or documented out-of-pocket expenses reasonably incurred by such party in connection with any investigation or proceeding. The parties hereto agree that it would not be just and equitable if contribution pursuant to this subsection 4.1.5 were determined by pro rata allocation or by any other method of allocation, which does not take account of the equitable considerations referred to in this subsection 4.1.5. No Person guilty of fraudulent misrepresentation (within the meaning of Section 11(f) of the Securities Act) shall be entitled to contribution pursuant to this subsection 4.1.5 from any Person who was not guilty of such fraudulent misrepresentation.

ARTICLE V MISCELLANEOUS

5.1 Notices. Any notice or communication under this Agreement must be in writing and given by (i) deposit in the United States mail, addressed to the party to be notified, postage prepaid and registered or certified with return receipt requested, (ii) delivery in person or by FedEx or other nationally recognized overnight delivery service providing evidence of delivery, or (iii) transmission by hand delivery or electronic mail. Each notice or communication that is mailed, delivered, or transmitted in the manner described above shall be deemed sufficiently given, served, sent, and received, in the case of mailed notices, on the third Business Day following the date on which it is mailed and, in the case of notices delivered by overnight delivery service, hand delivery, or electronic mail, at such time as it is delivered to the addressee (with the delivery receipt or the affidavit of messenger, but in the case of email, excluding any automated reply, such as an out-of-office notification) or at such time as delivery is refused by the addressee upon presentation. Any notice or communication under this Agreement must be addressed, (i) if to the Company, to: Tigo Energy, Inc., 655 Campbell Technology Parkway, Suite 150, Campbell, CA 95008, Attn: Zvi Alon, Zvi.Alon@tigoenergy.com; and a copy (which shall not constitute notice) shall also be sent to White & Case LLP, 1221 Avenue of the Americas, New York, NY 10019, Attn: Colin Diamond, cdiamond@whitecase.com, and Laura Katherine Mann, laurakatherine.mann@whitecase.com, (ii) if to the Sponsors to: Roth-CH IV Sponsors, 888 San Clemente Drive, Suite 400, Newport Beach, CA 92660, Attn: Byron Roth, broth@roth.com, and a copy (which shall not constitute notice) shall also be sent to DLA Piper LLP (US), 2525 East Camelback Road, Suite 1000, Phoenix, AZ 85016, Attn: Steven D. Pidgeon, steven.pidgeon@us.dlapiper.com, and, (iii) if to any Holder, at such Holder's address or facsimile number as set forth in the Company's books and records. Any party may change its address for notice at any time and from time to time by written notice to the other parties hereto, and such change of address shall become effective thirty (30) calendar days after delivery of such notice as provided in this Section 5.1.

5.2 Assignment; No Third Party Beneficiaries.

5.2.1 This Agreement and the rights, duties and obligations of the Company hereunder may not be assigned or delegated by the Company in whole or in part.

5.2.2 Prior to the expiration of the applicable Lock-Up Period, no Holder may assign or delegate such Holder's rights, duties or obligations under this Agreement, in whole or in part, except in connection with a transfer of Registrable Securities by such Holder to a Permitted Transferee.

5.2.3 Following the expiration of the applicable Lock-Up Period, a Holder may assign or delegate such Holder's rights, duties or obligations under this Agreement, in whole or in part, to any transferee of Registrable Securities.

5.2.4 This Agreement and the provisions hereof shall be binding upon and shall inure to the benefit of each of the parties and its successors and the permitted assigns of the Holders, which shall include Permitted Transferees.

5.2.5 This Agreement shall not confer any rights or benefits on any Persons that are not parties hereto, other than as expressly set forth in this Agreement and Section 5.2 hereof.

5.2.6 No assignment by any party hereto of such party's rights, duties and obligations hereunder shall be binding upon or obligate the Company unless and until the Company shall have received (i) written notice of such assignment as provided in Section 5.1 hereof and (ii) the written agreement of the assignee, in a form reasonably satisfactory to the Company, to be bound by the terms and provisions of this Agreement (which may be accomplished by an addendum or certificate of joinder to this Agreement). Any transfer or assignment made other than as provided in this Section 5.2 shall be null and void.

5.3 Severability. If any provision of this Agreement is held invalid or unenforceable by any court of competent jurisdiction, the other provisions of this Agreement shall remain in full force and effect. Furthermore, in lieu of any such invalid or unenforceable term or provision, the parties hereto intend that there shall be added as a part of this Agreement a provision as similar in terms to such invalid or unenforceable provision as may be possible that is valid and enforceable.

5.4 Headings: Counterparts. The headings in this Agreement are for convenience only and shall not be considered a part of or affect the construction or interpretation of any provision of this Agreement. This Agreement may be executed in two or more counterparts, each of which shall be deemed an original, but all of which together shall constitute the same instrument. Delivery of an executed counterpart of a signature page to this Agreement or any amendment hereto by electronic means, including DocuSign, e-mail, or scanned pages shall be effective as delivery of a manually executed counterpart to this Agreement or any amendment hereto.

5.5 Entire Agreement. This Agreement (including all agreements entered into pursuant hereto and all certificates and instruments delivered pursuant hereto and thereto) constitutes the entire agreement among the parties with respect to the subject matter hereof and supersedes any other agreements, whether written or oral, that may have been made or entered into by or among any of the parties hereto relating to the subject matter hereof. This Agreement will amend and restate the Existing Registration Rights Agreement to read as set forth herein, when it has been duly executed by parties having the right to so amend and restate the Existing Registration Rights Agreement.

5.6 Governing Law: Venue. NOTWITHSTANDING THE PLACE WHERE THIS AGREEMENT MAY BE EXECUTED BY ANY OF THE PARTIES HERETO, THE PARTIES EXPRESSLY AGREE THAT THIS AGREEMENT SHALL BE GOVERNED BY AND CONSTRUED UNDER THE LAWS OF THE STATE OF NEW YORK AS APPLIED TO AGREEMENTS AMONG NEW YORK RESIDENTS ENTERED INTO AND TO BE PERFORMED ENTIRELY WITHIN NEW YORK, WITHOUT REGARD TO THE CONFLICT OF LAW PROVISIONS OF SUCH JURISDICTION. The parties (a) hereby irrevocably and unconditionally submit to the jurisdiction of the Supreme Court of the State of New York, New York County and to the jurisdiction of the United States District Court for the Southern District of New York for the purpose of any suit, action or other proceeding arising out of or based upon this Agreement, (b) agree not to commence any suit, action or other proceeding arising out of or based upon this Agreement except in the above-named courts, and (c) hereby waive, and agree not to assert, by way of motion, as a defense, or otherwise, in any such suit, action or proceeding, any claim that it is not subject personally to the jurisdiction of the above-named courts, that its property is exempt or immune from attachment or execution, that the suit, action or proceeding is brought in an inconvenient forum, that the venue of the suit, action or proceeding is improper or that this Agreement or the subject matter hereof may not be enforced in or by such court.

5.7 **WAIVER OF TRIAL BY JURY.** EACH PARTY HERETO ACKNOWLEDGES AND AGREES THAT ANY CONTROVERSY WHICH MAY ARISE UNDER THIS AGREEMENT IS LIKELY TO INVOLVE COMPLICATED AND DIFFICULT ISSUES, AND, THEREFORE, EACH SUCH PARTY HEREBY IRREVOCABLY AND UNCONDITIONALLY WAIVES, TO THE FULLEST EXTENT PERMITTED BY APPLICABLE LAW, THE RIGHT TO A TRIAL BY JURY IN ANY ACTION, SUIT, CLAIM, COUNTERCLAIM OR OTHER PROCEEDING (WHETHER BASED ON CONTRACT, TORT OR OTHERWISE) ARISING OUT OF, UNDER, IN CONNECTION WITH OR RELATING TO THIS AGREEMENT, OR THE TRANSACTIONS CONTEMPLATED HEREBY.

5.8 **Amendments and Modifications.** Upon the written consent of the Company and the Holders of at least a majority in interest of the Registrable Securities at the time in question, compliance with any of the provisions, covenants and conditions set forth in this Agreement may be waived, or any of such provisions, covenants or conditions may be amended or modified; provided, however, that notwithstanding the foregoing, any amendment hereto or waiver hereof that adversely affects one Holder or group of affiliated Holders, solely in its capacity as a holder of the shares of the Company, in a manner that is materially different from the other Holders (in such capacity) shall require the consent of the Holder or group of affiliated Holders so affected. No course of dealing between any Holder or the Company and any other party hereto or any failure or delay on the part of a Holder or the Company in exercising any rights or remedies under this Agreement shall operate as a waiver of any rights or remedies of any Holder or the Company. No single or partial exercise of any rights or remedies under this Agreement by a party shall operate as a waiver or preclude the exercise of any other rights or remedies hereunder or thereunder by such party. Any amendment, termination, or waiver effected in accordance with this Section 5.8 shall be binding on each party hereto and all of such party's successors and permitted assigns, regardless of whether or not any such party, successor or assignee entered into or approved such amendment, termination, or waiver.

5.9 **Waivers.** Any party to this Agreement may extend the time for the performance of the obligations or acts of the other parties hereto or waive compliance by the other parties hereto with any of the agreements or conditions contained in this Agreement, but such extension or waiver shall be valid only if set forth in an instrument in writing signed by the party granting such extension or waiver. No waiver or extension of time for performance of any obligations or acts shall be deemed a waiver or extension of the time for performance of any other obligations or acts.

5.10 **Other Registration Rights.** The Company represents and warrants that, no Person, other than a Holder of Registrable Securities has any right to require the Company to register any securities of the Company for sale or to include such securities of the Company in any Registration filed by the Company for the sale of securities for its own account or for the account of any other Person. Further, the Company represents and warrants that this Agreement supersedes the Existing Registration Rights Agreement and any other registration rights agreement or agreement with similar terms and conditions and in the event of a conflict between any such agreement or agreements and this Agreement, the terms of this Agreement shall prevail.

5.11 **Term.** This Agreement shall terminate upon the earlier of (i) the tenth anniversary of the date of this Agreement and (ii) the date as of which no Registrable Securities remain outstanding; provided, that with respect to any Holder, this Agreement shall terminate on the date such Holder no longer holds any Registrable Securities. The provisions of Section 3.5 and ARTICLE IV shall survive any termination.

[SIGNATURE PAGES FOLLOW]

IN WITNESS WHEREOF, the undersigned have caused this Agreement to be executed as of the date first written above.

COMPANY:

TIGO ENERGY, INC.

By: _____
Name: _____
Title: _____

[Signature Page to Amended and Restated Registration Rights Agreement]

HOLDERS:

HOLDERS:

CR FINANCIAL HOLDINGS, INC.

By: _____
Name: _____
Title: _____

ROTH CAPITAL PARTNERS, LLC

By: _____
Name: _____
Title: _____

Aaron M. Gurewitz, as Trustee of the AMG Trust established January 23, 2007

Gordon Roth

Theodore Roth

Matt Day

Byron Roth

Andrew Costa

CHLM SPONSOR LLC

By: _____
Name: _____
Title: _____

HAMPSTEAD PARK CAPITAL MANAGEMENT, LLC

By: _____
Name: _____
Title: _____

Nazan Akdeniz

Lou Ellis

John Lipman

Molly Montgomery

Adam Rothstein

Sam Chawla

[Signature Page to Amended and Restated Registration Rights Agreement]

Aaron M. Gurewitz

Daniel M. Friedberg

Rick Hartfiel

[●]¹

¹ To be the holders of more than 5% of the Aggregate Fully Diluted Company Common Shares (as defined in the Merger Agreement).

[Signature Page to Amended and Restated Registration Rights Agreement]

SALE AND PURCHASE AGREEMENT

This Sale and Purchase Agreement (this “**Agreement**”) is made as of December 5, 2022, by and among Tigo Energy, Inc., a Delaware corporation (the “**Company**”), and the Persons set forth in Schedule 1 (the “**Sponsors**”). The Company and the Sponsors are sometimes individually referred to herein as a “**Party**” and collectively referred to herein as the “**Parties**.” Capitalized terms used but not defined herein have the meaning ascribed to them in that certain Agreement and Plan of Merger (the “**Merger Agreement**”), of even date herewith, by and among the Company, Roth CH Acquisition IV Co., a Delaware corporation, and Roth IV Merger Sub Inc., a Delaware corporation.

WHEREAS, as of immediately prior to the Closing (as defined below), the Sponsors are the registered and beneficial owners of 1,645,000 Founder Shares and 424,000 Acquiror Private Units, as set forth in Schedule 1 (collectively, the “**Shares**”); and

WHEREAS, in connection with the transactions contemplated by the Merger Agreement, the Sponsors desire and agree to sell the Shares to the Company, and the Company desires to purchase the Shares from the Sponsors, in exchange for the Sponsor Consideration.

NOW, THEREFORE, in consideration of the foregoing recitals, the mutual covenants and conditions hereinafter set forth, and for other good and valuable consideration, the receipt and sufficiency of which are hereby acknowledged, the Parties agree as follows:

1. Purchase of the Shares. Subject to the terms and conditions set forth herein, at the Closing (as defined in Section 2), the Sponsors shall sell, transfer and assign to the Company, and the Company shall purchase from the Sponsors all of the Sponsors’ right, title, and interest in and to the Shares for the Sponsor Consideration.

2. Closing Payment. Subject to the terms and conditions contained in this Agreement and the Merger Agreement, the purchase and sale of the Shares contemplated hereby shall be effective immediately prior to the Effective Time (“**Closing**”). In full and complete consideration for the Shares, and the performance of all of the Sponsors’ obligations, covenants and releases under this Agreement, on the Effective Date, the Company shall promptly pay each of the Sponsors, their pro rata portion of the Sponsor Consideration by wire transfer of immediately available funds to an account or accounts designated in writing by the Sponsors.

3. Representations and Warranties of Sponsors. Each Sponsor, severally and not jointly, hereby represents and warrants to the Company as follows:

(a) The Sponsor has all requisite power and authority to execute and deliver this Agreement, to perform its obligations hereunder and thereunder, and to sell the Shares. This Agreement, when executed and delivered by the Sponsor, will constitute valid and binding obligations of the Sponsor, enforceable with its terms.

(b) The Sponsor’s Shares have been duly authorized, are validly issued, fully paid and non-assessable, and are owned of record and beneficially by such Sponsor, free and clear of all liens, pledges, security interests, charges, claims, encumbrances, agreements, options, voting trusts, proxies and other arrangements or restrictions of any kind (“**Encumbrances**”). Upon consummation of the transactions contemplated by this Agreement, the Company shall own the Shares, free and clear of all Encumbrances.

(c) Neither the execution and delivery of this Agreement nor the performance by the Sponsor of the Sponsor’s obligations hereunder will: (i) contravene any provision contained in the governing documents of the Sponsor, to the extent such Sponsor is an entity; or (ii) violate or result in a material breach (with or without the lapse of time, the giving of notice or both) of or constitute a material default under (A) any material contract to which the Sponsor is a party, or (B) any material judgment, order, decree, statute, law, rule, or regulation or other restriction of any governmental authority, in each case to which the Sponsor is a party or by which it is bound or to which the Shares are subject.

(c) There is no action, suit, or proceeding at law or in equity by any person, or any arbitration or administrative or other proceeding, or any investigation by, any governmental authority or other instrumentality or agency, pending or threatened, with respect to the Sponsor which would reasonably be expected to prevent or materially impede the consummation of the transactions contemplated by this Agreement.

(d) No notice to, filing with, or authorization, registration, consent, or approval of any governmental authority or other person is necessary for the execution, delivery, or performance of this Agreement or the consummation of the transactions contemplated hereby.

(e) No agent, broker, investment banker, financial advisor, or other firm or person is entitled to any brokerage, finder's, financial adviser's or other similar fees or commission for which the Company could become liable in connection with the transactions contemplated by this Agreement based on arrangements made by or on behalf of the Sponsor.

4. Representations and Warranties of the Company. The Company hereby represents and warrants to the Sponsors as follows:

(a) The Company has all requisite power and authority to execute and deliver this Agreement, to perform its obligations hereunder and thereunder, and to purchase the Shares. This Agreement, when executed and delivered by the Company, will constitute valid and binding obligations of the Company, enforceable in accordance with its terms.

(b) Neither the execution and delivery of this Agreement nor the performance by the Company of the Company's obligations hereunder will: (i) contravene any provision contained in the governing documents of the Company; or (ii) violate or result in a material breach (with or without the lapse of time, the giving of notice or both) of or constitute a material default under (A) any material contract to which the Company is a party, or (B) any material judgment, order, decree, statute, law, rule, or regulation or other restriction of any governmental authority, in each case to which the Company is a party or by which it is bound or to which the Shares are subject.

(c) There is no action, suit, or proceeding at law or in equity by any person, or any arbitration or administrative or other proceeding, or any investigation by, any governmental authority or other instrumentality or agency, pending or threatened, with respect to the Company which would reasonably be expected to prevent or materially impede the consummation of the transactions contemplated by this Agreement.

(d) No notice to, filing with, or authorization, registration, consent, or approval of any governmental authority or other person is necessary for the execution, delivery, or performance of this Agreement or the consummation of the transactions contemplated hereby.

(e) No agent, broker, investment banker, financial advisor, or other firm or person is entitled to any brokerage, finder's, financial adviser's or other similar fees or commission for which the Sponsors could become liable in connection with the transactions contemplated by this Agreement based on arrangements made by or on behalf of the Company.

5. Survival. All representations and warranties contained herein shall survive the execution and delivery of this Agreement and the Closing hereunder.

6. Entire Agreement; Severability. This Agreement, the Merger Agreement and that certain Note Agreement, dated as of the date hereof, by and among the Company and the Sponsors set forth the entire understanding of the Parties hereto and supersedes any prior or contemporaneous written or oral agreement or understanding with respect to the subject matter hereof. This Agreement shall be fully binding upon, inure to the benefit of and be enforceable by, the Parties and their respective successors, assigns and legal representatives. In the event that any one or more of the provisions contained in this Agreement or in any other instrument referred to herein shall for any reason be held to be invalid, illegal or unenforceable in any respect, all other provisions of this Agreement shall nevertheless remain in full force and effect so long as the economic or legal substance of the transactions contemplated hereby is not affected in any manner materially adverse to any Party.

7. Further Assurances. Each Party agrees, at the reasonable request of any other Party, at any time and from time to time after the Effective Date, promptly to execute and deliver all such further documents, and promptly to take and forbear from all such action, as may be reasonably necessary or appropriate in order more effectively to confirm or carry out the provisions of this Agreement.

8. Expenses. All costs and expenses incurred in connection with this Agreement and the transactions contemplated hereby shall be paid by the party incurring such costs and expenses.

9. Withholding. Notwithstanding any other provision to this Agreement, the Company shall be entitled to deduct and withhold from any amount payable pursuant to this Agreement such Taxes that are required to be deducted and withheld from such amounts under the Code or any other applicable Law (as reasonably determined by the Company). The parties shall reasonably cooperate with each other in good faith to reduce or eliminate any applicable withholding and/or deduction (including through the request and provision of any statements, forms or other documents to reduce or eliminate any such deduction or withholding). To the extent that any amounts are so deducted and withheld, (i) such deducted and withheld amounts shall be timely remitted to the appropriate Governmental Authority and (ii) such timely remitted amounts shall be treated for all purposes of this Agreement as having been paid to the Person in respect of which such deduction and withholding was made.

10. Notices. All notices, requests, consents, claims, demands, waivers and other communications hereunder (each, a "Notice") shall be in writing and addressed to the Company at the address set forth on the signature page of this Agreement and to the Sponsors at the addresses set forth on Schedule 1 (or to such other address that may be designated by the receiving party from time to time in accordance with this Section 10). All Notices shall be delivered by personal delivery, nationally recognized overnight courier (with all fees pre-paid), facsimile or e-mail of a PDF document (with confirmation of transmission) or certified or registered mail (in each case, return receipt requested, postage prepaid). Except as otherwise provided in this Agreement, a Notice is effective only (a) upon receipt by the receiving party, and (b) if the party giving the Notice has complied with the requirements of this Section 10.

11. Successors and Assigns. This Agreement shall be binding upon and shall inure to the benefit of the Parties hereto and their respective successors and permitted assigns. No Party may assign any of its rights or obligations hereunder without the prior written consent of the other Parties hereto, which consent shall not be unreasonably withheld or delayed.

12. Governing Law: Jurisdiction. All disputes between the Parties hereto shall be governed by and construed in accordance with the domestic substantive laws of the State of Delaware, without giving effect to any choice or conflict of law provision or rule that would cause the application of the laws of any other jurisdiction. Any dispute between the parties arising out of this Agreement shall be subject to the exclusive jurisdiction of the state or federal courts of Delaware.

13. Amendments and Modification: Waiver. This Agreement may only be amended, modified or supplemented by an agreement in writing signed by each Party hereto. No waiver by any Party of any of the provisions hereof shall be effective unless explicitly set forth in writing and signed by the Party so waiving. Except as otherwise set forth in this Agreement, no failure to exercise, or delay in exercising, any rights, remedy, power or privilege arising from this Agreement shall operate or be construed as a waiver thereof, nor shall any single or partial exercise of any right, remedy, power or privilege hereunder preclude any other or further exercise thereof or the exercise of any other right, remedy, power or privilege.

14. Counterparts and Facsimiles. This Agreement may be executed in any number of counterparts, each such counterpart shall be deemed to be an original instrument, and all such counterparts together shall constitute one agreement. The Parties agree that facsimile or digital signatures shall be accepted as original signatures to this Agreement.

[THE REMAINDER OF THE PAGE IS INTENTIONALLY LEFT BLANK]

IN WITNESS WHEREOF, the Company has executed this Agreement as of the date first written above.

COMPANY:

TIGO ENERGY, INC.

By: /s/ Zvi Alon
Name: Zvi Alon
Title: Chief Executive Officer

Address for Notice:

Tigo Energy, Inc.
655 Campbell Technology Parkway
Suite 150
Campbell, CA 95008
Attn: Zvi Alon
Email: Zvi.Alon@tigoenergy.com

with copies to (which shall not constitute notice):

White & Case LLP
1221 Avenue of the Americas
New York, New York 10020
Attn: Colin Diamond
Bryan Luchs
Laura Katherine Mann
Email: cdiamond@whitecase.com
bryan.luchs@whitecase.com
laurakatherine.mann@whitecase.com

[Signature Page to Sale and Purchase Agreement]

IN WITNESS WHEREOF, the Sponsors have executed this Agreement as of the date first written above.

CR FINANCIAL HOLDINGS, INC.

By: /s/ Gerald Mars
Name: Gerald Mars
Title: CFO

ROTH CAPITAL PARTNERS, LLC

By: /s/ Byron Roth
Name: Byron Roth
Title: CEO

/s/ Aaron M. Gurewitz
Aaron M. Gurewitz, as Trustee of the AMG Trust established January 23, 2007

/s/ Gordon Roth
Gordon Roth

/s/ Theodore Roth
Theodore Roth

/s/ Matt Day
Matt Day

/s/ Byron Roth
Byron Roth

/s/ Andrew Costa
Andrew Costa

CHLM SPONSOR LLC

By: /s/ Steven Dyer
Name: Steven Dyer
Title: CEO

HAMPSTEAD PARK CAPITAL MANAGEMENT, LLC

By: /s/ Daniel Friedberg
Name: Daniel Friedberg
Title: Managing Partner

/s/ Nazan Akdeniz
Nazan Akdeniz

/s/ Lou Ellis
Lou Ellis

/s/ John Lipman
John Lipman

/s/ Molly Montgomery
Molly Montgomery

/s/ Adam Rothstein
Adam Rothstein

/s/ Sam Chawla
Sam Chawla

PROMISSORY NOTE

December 5, 2022

FOR VALUE RECEIVED, the Sponsors, as set forth in Schedule 1 attached thereto (the "Sponsors"), hereby unconditionally promise, jointly and severally, to pay to the Company the aggregate amount of all Sponsor Advances (as defined in the Agreement referred to below) from time to time made available by the Company to the Sponsors in accordance with Section 6.4 of the Agreement, together with all accrued interest thereon, as provided in this Promissory Note (this "Note") and issues this Note to TIGO ENERGY, INC. (the "Company") in accordance with that certain Agreement and Plan of Merger, dated as of December 5, 2022, by and among ROTH CH ACQUISITION IV CO., a Delaware corporation ("Roth CH") and ROTH IV MERGER SUB INC., a Delaware corporation and a direct, wholly-owned Subsidiary of Roth CH, and the Company (the "Agreement"). Capitalized terms used but not defined herein shall have the meaning assigned to such terms in the Agreement.

1. Payment Date

(a) Payment Date. The aggregate unpaid principal amount of the Sponsor Advances, all accrued and unpaid interest, and all other amounts payable under this Note shall be due and payable on July 6, 2023 (the "Maturity Date"); or (ii) upon earlier acceleration of this Note following an Acceleration Event (as provided below).

(b) Prepayment. The Sponsors may prepay this Note in whole or in part at any time or from time to time without penalty or premium by paying the principal amount to be prepaid together with accrued interest thereon to the date of prepayment.

2. Interest

(a) Interest. The Note shall have an interest rate equal to 4.50%, which is the December 2022 semiannual short term Applicable Federal Rate ("APR").

(b) Default Interest. If any amount payable hereunder is not paid when due (without regard to any applicable grace period), whether at stated maturity, by acceleration, or otherwise, such overdue amount shall, at the option of the Company, bear interest at the APR plus two percent (2%). Any default interest under this Note shall be payable in cash on demand.

(c) Computation of Interest. All computations of interest hereunder shall be made on the basis of a year of 365 and 366 days, as the case may be, and in each case the actual number of days elapsed. Interest shall begin to accrue on the Sponsor Advances on the date each such Sponsor Advance is made. On any portion of this Note that is repaid, interest shall not accrue on the date on which such payment is made.

(d) Interest Rate Limitation. If at any time the interest rate payable on this Note shall exceed the maximum rate of interest permitted under applicable law, such interest rate shall be reduced automatically to the maximum rate permitted.

3. Payment Mechanics. The aggregate amount of all Sponsor Advances to the Company shall be made in Dollars and the Sponsors shall repay or cause to be repaid by wire transfer of immediately available funds no later than 3:00 PM, New York time, on the Maturity Date to the Company's account at a bank specified by the Company in writing to the Sponsors from time to time.

4. Acceleration Event. Upon the occurrence of any of the following events (each, an “**Acceleration Event**”), the principal amount of the Note hereunder shall become immediately due and payable in full, together with interest accrued thereon:

- (a) the consummation of the transactions contemplated by the Sale and Purchase Agreement; or
- (b) three (3) Business Days following the termination of the Agreement in accordance with Section 10.1 of the Agreement or otherwise.

5. Event of Default. An “**Event of Default**” hereunder shall occur if the Sponsors fail to pay (a) any principal amount of or interest on the Sponsor Advances when due, (b) any other amount due hereunder within five (5) days after such amount is due, (c) any Sponsor’s insolvency or inability to meet obligations as they become due; or (d) any Sponsors’ filing of a petition for relief in bankruptcy. Should Company prevail in any proceeding to enforce an obligation under this Note, Company shall be entitled to recover its costs, including reasonable attorneys’ fees.

6. Remedies. Upon the occurrence and during the continuance of an Event of Default, the Company may, at its option, by written notice to the Sponsors, declare the outstanding principal amount of the Sponsor Advances, accrued and unpaid interest thereon, and all other amounts payable hereunder immediately due and payable. Upon the occurrence of any Event of Default described in Section 5(c) or (d) above, the outstanding principal amount of the Sponsor Advances, all accrued and unpaid interest thereon, and all other amounts payable hereunder shall become immediately due and payable without notice or other action by the Company.

7. Expenses. All reasonable and documented out-of-pocket costs, expenses, and fees, including the reasonable fees and expenses of counsel, incurred by the Company in connection with the negotiation, documentation, and execution of this Note and the enforcement of the Company’s rights hereunder shall be deemed Acquiror Extension Expenses.

8. Notices. All notices and other communications among the parties shall be in writing and shall be deemed to have been duly given (i) when delivered in person, (ii) when delivered after posting in the United States mail having been sent registered or certified mail return receipt requested, postage prepaid, (iii) when delivered by FedEx or other nationally recognized overnight delivery service, or (iv) when delivered by email during normal business hours (and otherwise as of the immediately following Business Day) (excluding any automated reply, such as an out-of-office notification), addressed as follows:

If to the Sponsors, to:

Roth CH Sponsors
888 N Clemente Drive, Suite 400
Newport Beach, CA 92660
Attention: Byron Roth
Email: broth@roth.com

with copies to (which shall not constitute notice):

DLA Piper LLP (US)
2525 East Camelback Road, Suite 1000
Phoenix, AZ 85016
Attention: Steven D. Pidgeon
Email: steven.pidgeon@us.dlapiper.com

If to the Company, to:

Tigo Energy, Inc.
655 Campbell Technology Parkway
Suite 150
Campbell, CA 95008
Attention: Zvi Alon
Email: Zvi.Alon@tigoenergy.com
with copies to (which shall not constitute notice):

White & Case LLP
1221 Avenue of the Americas
New York, New York 10020
Attention: Colin Diamond
Bryan Luchs
Laura Katherine Mann
Email: cdiamond@whitecase.com
bryan.luchs@whitecase.com
laurakatherine.mann@whitecase.com

or to such other address or addresses as the parties may from time to time designate in writing. Copies delivered solely to outside counsel shall not constitute notice.

9. Governing Law. This Note and any claim, controversy, dispute, or cause of action (whether in contract, tort, or otherwise) based on, arising out of, or relating to this Note shall be governed by and construed in accordance with the laws of the State of Delaware.

10. Disputes.

(a) This Note, and all actions based upon, arising out of, or related to this Note shall be governed by, and construed in accordance with, the Laws of the State of Delaware, without giving effect to principles or rules of conflict of Laws to the extent such principles or rules would require or permit the application of Laws of another jurisdiction. Any proceeding or action based upon, arising out of or related to this Note must be brought in the Court of Chancery in the City of Wilmington, New Castle County, Delaware or, in the event such court lacks subject matter jurisdiction, the United States District Court sitting in Wilmington, Delaware or, in the event such federal district court lacks subject matter jurisdiction, then in the Superior Court in the City of Wilmington, New Castle County, Delaware, and each of the parties irrevocably (i) submits to the exclusive jurisdiction of each such court in any such proceeding or action, (ii) waives any objection it may now or hereafter have to personal jurisdiction, venue or to convenience of forum, (iii) agrees that all claims in respect of the proceeding or action shall be heard and determined only in any such court, and (iv) agrees not to bring any proceeding or action arising out of or relating to this Note in any other court. In addition, each of the parties further agrees that service of any process, summons, notice or document by U.S. registered mail (or similar private providers of mail services) to such party's respective primary address shall be effective service of process with respect to any matters brought hereunder. Nothing herein contained shall be deemed to affect the right of any party to serve process in any manner permitted by Law or to commence actions or otherwise proceed against any other party in any other jurisdiction, in each case, to enforce judgments obtained in any action, suit or proceeding brought pursuant to this section.

(b) EACH PARTY HERETO ACKNOWLEDGES AND AGREES THAT ANY CONTROVERSY WHICH MAY ARISE UNDER THIS NOTE IS LIKELY TO INVOLVE COMPLICATED AND DIFFICULT ISSUES, AND THEREFORE EACH SUCH PARTY HEREBY IRREVOCABLY, UNCONDITIONALLY AND VOLUNTARILY, TO THE FULLEST EXTENT PERMITTED BY LAW, WAIVES ANY RIGHT SUCH PARTY MAY HAVE TO A TRIAL BY JURY IN RESPECT OF ANY ACTION, SUIT OR PROCEEDING DIRECTLY OR INDIRECTLY ARISING OUT OF OR RELATING TO THIS NOTE.

11. Successors and Assigns. This Note will be binding upon the parties hereto and their respective successors and assigns and will inure to the benefit of the parties hereto and the successors and assigns of the Company. No Sponsor's rights or obligations hereunder nor any interest therein may be assigned or delegated by any Sponsor without the prior written consent of the Company. Nothing in this Note, expressed or implied, will be construed to confer upon any Person (other than the parties hereto, their respective successors and assigns permitted hereby and, to the extent expressly contemplated hereby), any legal or equitable right, remedy or claim under or by reason of this Note.

12. Withholding. Notwithstanding anything to the contrary herein or in the Agreement, all payments to be made to the Company under this Note shall be made free and clear and without deduction for any withholding Taxes or other amounts unless such amount is required under applicable Tax law to be deducted and withheld, *provided*, that the parties agree that no U.S. withholding Tax shall be withheld or deducted from any payment made to the Company to the extent a duly executed IRS Form W-9 of the Company is provided to the Sponsors. If any Taxes imposed or levied by or on behalf of any jurisdiction (or political subdivision or taxing authority thereof or therein) in which a Sponsor (or its regarded beneficial owner(s), if applicable) is, for tax purposes, organized or resident or doing business or through which payment or delivery is made or deemed to be made are required to be deducted or withheld, such Sponsor shall remit the full amount deducted or withheld to the relevant taxing authority in accordance with applicable law and pay or deliver to the Company an additional amount as may be necessary to ensure that the net amount received by the Company after such deduction or withholding (and after withholding or deducting any Taxes on such additional amounts) will equal to the amounts that would have been received by the Company had no such withholding or deduction been required.

13. Integration. This Note constitutes the entire contract between the Company and the Sponsors with respect to the subject matter hereof and supersedes all previous agreements and understandings, oral or written, with respect thereto.

14. Amendments and Waivers. No term of this Note may be waived, modified, or amended, except by an instrument in writing signed by the Company and the Sponsors. Any waiver of the terms hereof shall be effective only in the specific instance and for the specific purpose given.

15. No Waiver; Cumulative Remedies. No failure by the Sponsors to exercise and no delay in exercising any right, remedy, or power hereunder shall operate as a waiver thereof; nor shall any single or partial exercise of any right, remedy, or power hereunder preclude any other or further exercise thereof or the exercise of any other right, remedy, or power. The rights, remedies, and powers herein provided are cumulative and not exclusive of any other rights, remedies, or powers provided by law.

16. Severability. If any term or provision of this Note is invalid, illegal, or unenforceable in any jurisdiction, such invalidity, illegality, or unenforceability shall not affect any other term or provision of this Note or render such term or provision invalid or unenforceable in any other jurisdiction.

17. Counterparts. This Note and any amendments, waivers, consents, or supplements hereto may be executed in counterparts, each of which shall constitute an original, but all of which taken together shall constitute a single contract. Delivery of an executed counterpart of a signature page to this Note by facsimile or in electronic (“pdf” or “tif”) format shall be as effective as delivery of a manually executed counterpart of this Note.

18. Electronic Execution. The words “execution,” “signed,” “signature,” and words of similar import in this Note shall be deemed to include electronic and digital signatures and the keeping of records in electronic form, each of which shall be of the same effect, validity, and enforceability as manually executed signatures and paper-based recordkeeping systems, to the extent and as provided for under applicable law, including the Electronic Signatures in Global and National Commerce Act of 2000 (15 U.S.C. § 7001 *et seq.*), the Electronic Signatures and Records Act of 1999 (N.Y. State Tech. Law §§ 301-309), and any other similar state laws based on the Uniform Electronic Transactions Act.

19. Intended Tax Treatment. Each of the Company and the Sponsors acknowledges and agrees (i) that this Note is intended to be treated as indebtedness of the Sponsors for U.S. federal income tax purposes (and any analogous provision of state or local law), and (ii) to report the Note and all payments hereunder consistent with such intended tax treatment for all applicable tax purposes unless otherwise required by applicable law.

[signature page follows]

IN WITNESS WHEREOF, the Sponsors have executed this Note as of the date first written above.

CR FINANCIAL HOLDINGS, INC.

By: /s/ Gerald Mars
Name: Gerald Mars
Title: CFO

ROTH CAPITAL PARTNERS, LLC

By: /s/ Byron Roth
Name: Byron Roth
Title: CEO

CHLM SPONSOR LLC

By: /s/ Steven Dyer
Name: Steven Dyer
Title: CEO

HAMPSTEAD PARK CAPITAL MANAGEMENT, LLC

By: /s/ Daniel Friedberg
Name: Daniel Friedberg
Title: Managing Partner

/s/ Byron Roth
Byron Roth

/s/ Aaron M. Gurewitz
Aaron M. Gurewitz, as Trustee of the AMG Trust established January 23, 2007

[Signature Page to Promissory Note]

/s/ Gordon Roth
Gordon Roth

/s/ Theodore Roth
Theodore Roth

/s/ Matt Day
Matt Day

/s/ Andrew Costa
Andrew Costa

/s/ Nazan Akdeniz
Nazan Akdeniz

/s/ Lou Ellis
Lou Ellis

/s/ John Lipman
John Lipman

/s/ Molly Montgomery
Molly Montgomery

/s/ Adam Rothstein
Adam Rothstein

/s/ Sam Chawla
Sam Chawla

[Signature Page to Promissory Note]

ACKNOWLEDGED AND ACCEPTED BY

TIGO ENERGY, INC.,

By: /s/ Zvi Alon
Name: Zvi Alon
Title: Chief Executive Officer

[Signature Page to Promissory Note]

Schedule 1

Sponsors

1. CR Financial Holdings, Inc., a California corporation.
 2. Roth Capital Partners, LLC, a Delaware limited liability company
 3. CHLM Sponsor LLC, a Delaware limited liability company
 4. Hampstead Park Capital Management, LLC, a Delaware limited liability company
 5. Byron Roth
 6. Aaron M. Gurewitz, as Trustee of the AMG Trust established January 23, 2007
 7. Gordon Roth
 8. Theodore Roth
 9. Matt Day
 10. Andrew Costa
 11. Nazan Akdeniz
 12. Lou Ellis
 13. John Lipman
 14. Molly Montgomery
 15. Adam Rothstein
 16. Sam Chawla
-

RESTRICTIVE COVENANT AGREEMENT

This Restrictive Covenant Agreement (this "Agreement"), dated [●], and is effective as of the date of the consummation of the transactions contemplated by the Merger Agreement (as defined below) (the "Effective Date"), is made and entered into by and between Tigo Energy, Inc., a Delaware corporation (the "Company") and the Person identified as the Restricted Party on the signature pages hereto (the "Restricted Party"). The Company and the Restricted Party are collectively referred to herein as the "Parties". Capitalized terms used and not otherwise defined herein have the meanings set forth in Section 4.1 below or the Merger Agreement (as defined below), as applicable.

RECITALS

- A. The Company has entered into that certain Agreement and Plan of Merger, dated as of December 5, 2022 (the "Merger Agreement"), among the Company, Roth CH Acquisition IV Co., a Delaware corporation ("Acquiror"), and Roth IV Merger Sub Inc., a Delaware corporation and a direct, wholly-owned Subsidiary of Acquiror ("Merger Sub"), pursuant to which, among other things, (i) Merger Sub will merge with and into the Company, the separate corporate existence of Merger Sub will cease, and the Company will be the surviving corporation and a wholly-owned Subsidiary of Acquiror (the "Merger"), (y) the Company will change its name to "Tigo Energy MergeCo, Inc.," and (z) Acquiror will concurrently or shortly thereafter change its name to "Tigo Energy, Inc."
- B. The Restricted Party has and will continue to have knowledge of and access to Confidential Information that is proprietary to, highly sensitive, and constitutes valuable assets of, the Company.
- C. The going concern value of the Company would be substantially diminished if the Restricted Party were to compete with the Company or engage in other harmful behavior.
- D. Pursuant to the Merger Agreement, all of the Restricted Party's equity interests in the Company will be exchanged for equity interests in the Acquiror.
- E. Pursuant to the Merger Agreement, the Restricted Party's execution and delivery of this Agreement is a condition to the closing of the transactions contemplated by the Merger Agreement, and the Company would not consummate the transactions contemplated by the Merger Agreement without entering into this Agreement with the Restricted Parties.

AGREEMENT

The Parties agree as follows:

ARTICLE I
AGREEMENT

1.1 Adoption of Recitals; Effectiveness of Agreement. The Parties adopt the foregoing Recitals and agree and affirm that the construction of this Agreement will be guided thereby. If the Merger Agreement is terminated or the transactions contemplated thereby are not consummated for any reason, this Agreement shall not become effective, shall have no force or effect, and shall be null and void *ab initio*.

1.2 Inducement; Additional Consideration. As an inducement for the Company to consummate the transactions contemplated by the Merger Agreement, the Restricted Party agrees to the covenants and restrictions in this Agreement.

ARTICLE II
RESTRICTIVE COVENANTS

2.1 Legitimate Business Interests. The Restricted Party acknowledges that they have had and will continue to have access to the most sensitive and valuable trade secrets, proprietary information and other Confidential Information of the Company, which constitute valuable business assets of the Company, and the use, application or disclosure of such Confidential Information would cause immediate and irreparable harm to the Company, which could not be adequately remedied through the payment of monetary damages. Therefore, as an inducement for the Company to enter into the Merger Agreement and for the Company to consummate the transactions contemplated thereby and to protect the Confidential Information and other legitimate business interests of the Company, the Restricted Party hereby agrees to be bound by the restrictive covenants in this Article II, which the Parties expressly agree are reasonably and narrowly tailored to protect the Confidential Information and other legitimate business interests of the Company.

2.2 Confidentiality. The Restricted Party will keep confidential and not disclose to any other Person or use for the Restricted Party's own benefit or the benefit of any other Person (other than the Company) the terms of this Agreement and all Confidential Information; *provided that* a Restricted Party may disclose the terms of this Agreement and Confidential Information (i) to such Restricted Party's immediate family members, personal tax or financial advisors, attorneys, accountants and other advisors, who, in each case, agree to keep such information confidential,(ii) to the extent that disclosure is required by applicable Law or Governmental Order, *provided that* as soon as reasonably practicable before such disclosure, the Restricted Party gives the Company prompt written notice of such disclosure to enable the Company to seek a protective order or otherwise preserve the confidentiality of such information, (iii) the Confidential Information becomes generally known to or available for use by the public other than as a result of the Restricted Party's acts or omissions, or (iv) with respect to the terms of this Agreement only, to prospective future employers or prospective business partners solely for the purpose of disclosing the limitations on the Restricted Party's conduct imposed by this Agreement, who agree to keep such information confidential. For the avoidance of doubt, nothing in this Agreement prohibits the Restricted Party from reporting possible violations of federal law or regulation to any governmental agency or entity, or making other disclosures that are protected under the whistleblower provisions of federal law or regulation, or otherwise cooperating or communicating with any such agencies or entities that may be investigating possible unlawful conduct (including providing documents or other information such agencies or entities without notice to the Company). This Agreement does not prohibit the Restricted Party from enforcing the Restricted Party's rights under this Agreement or under any other agreement between the Restricted Party and the Company or any of its Affiliates or defending against any claims, suits, actions or other legal proceedings between the Restricted Party and the Company, responding to breaches of this Agreement, or otherwise cooperating. The Restricted Party does not need the prior authorization of the Company or any of its Affiliates to make such reports or disclosures and the Restricted Party is not required to disclose to the Company or any of its Affiliates that the Restricted Party has made such reports or disclosures. In addition, pursuant to 18 USC Section 1833(b), the Restricted Party shall not be held criminally or civilly liable under any federal or state trade secret law for the disclosure of a trade secret that is made: (1) in confidence to a federal, state or local governmental official, either directly or indirectly, or to an attorney, and solely for the purpose of reporting or investigating a suspected violation of law; or (2) in a complaint or other document filed in a lawsuit or other proceeding, if such filing is made under seal. If the Restricted Party files a lawsuit for retaliation by the Company or any of its Affiliates for reporting a suspected violation of law, the Restricted Party may disclose the Company's or such Affiliate's trade secrets to an attorney and use the trade secret information in the court proceeding; *provided that* such Restricted Party files (i) any document containing the trade secret under seal and (ii) does not disclose the trade secret except pursuant to court order.

2.3 Non-Competition.

(a) **Restrictions.** The Restricted Party agrees and covenants that, during the Restricted Period, they will not, directly or indirectly, individually or on behalf of or in coordination with any Affiliate or other Person engage in the Business, or participate in the ownership, operation, control or financing of, or be connected as an owner, investor, partner, joint venturer, director, manager, officer, employee, independent contractor, consultant or other agent of, or have any other financial relationship in or with, any Person or enterprise that, directly or indirectly, engages in the Business, in each case, anywhere within or with respect to the Restricted Territory.

(b) **General Exceptions.** Nothing in this Section 2.3 will prohibit the Restricted Party from (i) owning, in the aggregate, less than two percent (2%) of any publicly traded securities as long as the Restricted Party does not participate in the management, operation or control of such entity; or (ii) trading in stocks, bonds, securities, real estate, commodities or other forms of investment for his/her/its own benefit as long as such activity does not materially interfere with the Restricted Party's job duties under his or her employment agreement(s) with the Company.

2.4 Non-Solicitation. The Restricted Party agrees and covenants that, during the Restricted Period, they will not, directly or indirectly, on such Restricted Party's own behalf or on behalf of any other Person: (a) hire, engage, retain, solicit or otherwise enter into any business relationship with (including by recruiting, identifying or targeting as a candidate for recruitment) any Company personnel (whether a director, officer, employee or independent contractor or in any other capacity) who is currently providing services to the Company and who was providing services while the Restricted Party was employed by the Company, or attempt or assist anyone else to do so, or induce any Company personnel to terminate, restrict or hinder such Company personnel's employment or association with the Company or intentionally interfere in any way with the relationship between such Company personnel and the Company; or (b) solicit, interfere with or induce or attempt to solicit, interfere with or induce, directly or indirectly, any of the following Persons to terminate, restrict, or hinder such Person's association with the Company: a customer, supplier, vendor, broker, lessor, lessee, dealer, distributor, licensor, equityholder, lender, joint venturer, consultant, agent or other Person having a business relationship with the Company, at any time within the twelve (12)-month period immediately preceding the date of any such solicitation, interference or inducement (or attempt thereto) (or, if the date of the challenged activity is following termination of employment, then instead is or was such a customer, supplier, vendor, broker, lessor, lessee, dealer, distributor, licensor, equityholder, lender, joint venture, consultant, agent or other Person having a business relationship with the Company as of the date of such termination). Notwithstanding the foregoing, (a) nothing herein shall preclude a general solicitation through a public medium or general or mass mailing by the Restricted Party or on behalf of the Restricted Party and not directly or indirectly targeted at such employee, customer, or other Person covered by this Section 2.4, and (b) the Restricted Party may hire any such employee or personnel whose employment or services have been terminated more than six (6) months prior to such hiring by the Restricted Party without inducement or solicitation by the Restricted Party.

2.5 Non-Disparagement. During the Restricted Period, the Restricted Party agrees and covenants that they will not, directly or indirectly, make any disparaging, derogatory, negative or knowingly false statement about the Company or any of their directors, managers, officers, employees, agents, successors and permitted assigns, or any of their respective businesses, operations, financial condition or prospects, except as required by applicable Law or Governmental Order or in the course of filing a charge with a government agency or participating in its investigation; provided, that truthful responses (written or verbal) in connection with any legal process, performance evaluation, or audit shall not be a violation hereof. For the avoidance of doubt, nothing in this Agreement prohibits the Restricted Party from reporting possible violations of federal law or regulation to any governmental agency or entity, or making other disclosures that are protected under the whistleblower provisions of federal law or regulation, or otherwise cooperating or communicating with any such agencies or entities that may be investigating possible unlawful conduct (including providing documents or other information such agencies or entities without notice to the Company). This Agreement does not prohibit the Restricted Party from enforcing the Restricted Party's rights under this Agreement or under any other agreement between the Restricted Party and the Company or any of its Affiliates or defending against any claims, suits, actions or other legal proceedings between the Restricted Party and the Company, responding to breaches of this Agreement, or otherwise cooperating.

2.6 Use of Entity Names. The Restricted Party will not, directly or indirectly, use (or cause to be used) any of the names "Tigo", "Tigo Energy", "Tigo Energy MergeCo" or any other business, trade or fictitious name of the Company (including, in each case, acronyms and derivations thereof) without the Company's express prior written consent (which may be withheld by the Company in its sole discretion).

2.7 Independence. The existence of any claim, demand, action or cause of action of the Restricted Party against the Company, whether predicated on this Agreement or otherwise, will not constitute a defense to the enforcement by the Company of any covenant or agreement of the Restricted Party in this Agreement. Nothing in this Agreement will supersede or otherwise adversely affect the validity of any restrictive covenant (including confidentiality, non-competition, non-solicitation and similar covenants) in any other agreement to which the Restricted Party and the Company are parties.

2.8 Scope of Covenants; Equitable Relief. The Restricted Party acknowledges and agrees that (a) the restrictive covenants in this Article II and the territorial, time, activity and other limitations set forth herein are commercially reasonable and do not impose a greater restraint than is necessary to protect the goodwill and legitimate business interests of the Company, (b) any breach of the restrictive covenants in this Article II will cause immediate and irreparable harm to the Company, which could not be adequately remedied through the payment of monetary damages, (c) if any breach of any such covenant occurs, then the Company will be entitled to seek injunctive relief (without the posting of a bond or similar security) in addition to such other legal and equitable remedies that may be available (without limiting the availability of legal or equitable, including injunctive, remedies under any other provisions of this Agreement), (d) the Restricted Party hereby waives the claim or defense that an adequate remedy at law exists for such a breach, and (e) in the event any covenant in this Article II is found to be unreasonable by an arbitrator or a court, the Restricted Party agrees to such other restriction(s) as such arbitrator or court may determine to be reasonable and shall not assert that such covenant should be eliminated in its entirety by such arbitrator or court.

2.9 Equitable Tolling. If the Restricted Party breaches any covenant in this Article II, then the duration of such covenant will be tolled with respect to the Restricted Party for a period of time equal to the time of such breach and, if the Company seeks injunctive relief or other remedies for any such breach, then the duration of such covenant will be tolled with respect to the Restricted Party for a period of time equal to the pendency of such proceedings (including all appeals).

ARTICLE III RESTRICTED PARTY REPRESENTATIONS AND WARRANTIES

The Restricted Party hereby represents and warrants to the Company, as of the Effective Date, that:

3.1 Power and Authority. The Restricted Party is a natural Person. The Restricted Party has full power, authority and legal capacity to enter into and perform this Agreement.

3.2 Enforceability. This Agreement has been duly executed and delivered by the Restricted Party and constitutes a valid and legally binding obligation of the Restricted Party, enforceable against the Restricted Party in accordance with its terms, except as may be limited by applicable bankruptcy, insolvency, moratorium and similar generally applicable Laws regarding creditors' rights or by general equity principles.

3.3 Consents. No consent, authorization, Governmental Order or approval of, or filing or registration with, any governmental authority or other Person is required for the Restricted Party's execution and delivery of this Agreement.

3.4 No Conflicts. Neither the Restricted Party's execution and delivery of this Agreement nor the Restricted Party's performance under this Agreement will conflict with or result in a breach of any provision of any Law or Governmental Order to which the Restricted Party is party or by which such Restricted Party is bound. The Restricted Party is not a party to or bound by any contract or other agreement under which (a) the Restricted Party's execution and delivery of or performance under this Agreement will constitute a default, breach or event of acceleration or (b) performance by the Restricted Party according to the terms of this Agreement may be prohibited, prevented or delayed.

3.5 Acknowledgment. The Restricted Party (a) has read and fully understands this Agreement; (b) has been given sufficient time to consider the Restricted Party's actions in respect of this Agreement; (c) has had the opportunity to obtain independent legal and other advice with respect to this Agreement; and (d) has either obtained such advice or declined on the Restricted Party's own account to obtain such advice and is proceeding with entering into this Agreement. The Restricted Party further acknowledges and agrees that the restrictions set forth in this Agreement are being entered into by it in connection with the Merger Agreement, that the Restricted Party will receive good and valuable consideration as a result of the consummation of the transactions contemplated by the Merger Agreement and that the Company would not have entered into the Merger Agreement or consummated the transactions contemplated thereby in the absence of this Agreement.

ARTICLE IV DEFINED TERMS

4.1 Definitions. For purposes of this Agreement, the following terms have the meanings set forth below.

"**Business**" means (i) research, development and manufacturing of (1) smart hardware and software solutions that enhance safety, increase energy yield, and lower operating costs of residential, commercial and utility-scale solar systems, (2) other solar products, including inverters and battery storage units, and (ii) the sales, distribution and monitoring of certain components of residential, commercial and utility-scale solar systems.

"**Confidential Information**" means all confidential, proprietary and trade secret information (including all tangible and intangible embodiments thereof) that concerns the Company, the services, processes or products offered by the Company, including lists of and information regarding current and prospective customers, referral sources, vendors and suppliers of the Company, personnel information (including the identity of former, current and prospective directors, officers, employees, independent contractors and other business relations of the Company and the responsibilities, competence, abilities and compensation of such Persons), computer programs, unpatented inventions, discoveries or improvements, testing and treatment techniques and results, marketing, manufacturing, or organizational research and development, contracts and contractual relations, licenses, accounting ledgers and financial statements, business plans, forecasts and projections, business methods, pricing and financial information, information concerning planned or pending acquisitions or divestitures, and information concerning purchases of real property or major equipment or other personal property, and any other information or data that the Company treats as proprietary or designates as confidential information, whether or not owned or developed by the Company; *provided, however*, that "Confidential Information" does not include any information that the Restricted Party can demonstrate has been made generally available to the public (other than through the Restricted Party's breach of this Agreement or, to the Restricted Party's knowledge, by a third-party's breach of a confidentiality covenant).

"**Restricted Period**" means the period from the Closing Date to the date that is four (4) years after the Closing Date.

"**Restricted Territory**" means any location where the Company conducts the Business.

**ARTICLE V
GENERAL PROVISIONS**

5.1 Notices. All notices and other communications required or permitted under this Agreement (a) must be in writing, (b) will be duly given (i) when delivered personally to the recipient or sent to the recipient by facsimile (with delivery confirmation retained), (ii) upon transmission if by electronic email (provided no error message or delivery failure message is received by the sender) or (iii) one (1) Business Day after being sent to the recipient by nationally recognized overnight private carrier (charges prepaid) and (c) addressed as follows (as applicable):

If to a Restricted Party, to the address reflected on the Restricted Party's signature page to this Agreement.

If to the Company:

Tigo Energy, Inc.
655 Campbell Technology Parkway
Suite 150
Campbell, CA 95008
Attn: Zvi Alon
Email: Zvi.Alon@tigoenergy.com

with a copy (which shall not constitute notice) to:

White & Case LLP
1221 Avenue of the Americas
New York, New York 10020
Attn: Colin Diamond
Bryan Luchs
Laura Katherine Mann
Email: cdiamond@whitecase.com
bryan.luchs@whitecase.com
laurakatherine.mann@whitecase.com

or to such other respective address as each Party may designate by notice given in accordance with this [Section 5.1](#).

5.2 Amendments and Waivers. No amendment of any provision of this Agreement shall be valid unless the same shall be in writing and signed by the Company and the Restricted Parties. No waiver by any Party of any provision of this Agreement or any default, misrepresentation, or breach of warranty or covenant hereunder, whether intentional or not, shall be valid unless the same shall be in writing and signed by the Party making such waiver nor shall such waiver be deemed to extend to any prior or subsequent default, misrepresentation, or breach of warranty or covenant hereunder or affect in any way any rights arising by virtue of any prior or subsequent such occurrence.

5.3 Assignment. The Restricted Parties may not assign this Agreement or any rights under this Agreement, or delegate any duties under this Agreement, without the Company's prior written consent. The Company may freely assign this Agreement and any rights under this Agreement or delegate any duties under this Agreement without the prior written consent of the Restricted Parties.

5.4 Binding Effect; Benefit. This Agreement will inure to the benefit of and bind the Parties and their respective successors and permitted assigns. Nothing in this Agreement, express or implied, may be construed to give any Person other than the Parties, and their respective successors and permitted assigns any right, remedy, claim, obligation or liability arising from or related to this Agreement.

5.5 Severability. If any court of competent jurisdiction holds any provision of this Agreement invalid or unenforceable, then the other provisions of this Agreement will remain in full force and effect. Any provision of this Agreement held invalid or unenforceable only in part or degree will remain in full force and effect to the extent not held invalid or unenforceable and upon a determination that any provision of this Agreement is invalid or unenforceable, such provision shall be replaced, to the extent legally possible, with a legal, enforceable and valid provision that is as similar in tenor to the stricken provision.

5.6 References. When a reference is made in this Agreement to the preamble or Recitals or an Article, Section, clause, such reference shall be deemed to be to this Agreement unless otherwise indicated. Whenever the words "include," "includes" or "including" are used in this Agreement, they shall be deemed to be followed by the words "without limitation." Words of one gender shall be held to include the other gender as the context requires. The word "or" shall not be exclusive. The words "herein," "hereof," "hereunder" or "hereby" and similar terms are to be deemed to refer to this Agreement as a whole and not to any specific section. Unless otherwise specified herein, references to any statute, listing rule, rule, standard, regulation or other law include a reference to the corresponding rules and regulations and each of them as amended, modified, supplemented, consolidated, replaced or rewritten from time to time. References to any section of any statute, listing rule, rule, standard, regulation or other law include any successor to such section. References to any contract (including this Agreement) are to the contract as amended, modified, supplemented or replaced from time to time, unless otherwise stated. References to any Person include such Person's predecessors or successors, whether by merger, consolidation, reorganization or otherwise, and permitted assigns.

5.7 Construction. Each Party herein expressly represents and warrants to the other Parties that before executing this Agreement, said Party has fully informed itself of the terms, contents, conditions and effects of this Agreement; said Party has relied solely and completely upon its own judgment in executing this Agreement; said Party has had the opportunity to seek and has obtained the advice of counsel before executing this Agreement, which is the result of arm's length negotiations conducted by and among the Parties and their respective counsel. This Agreement shall be deemed drafted jointly by the Parties and nothing shall be construed against one Party or another as the drafting Party.

5.8 Governing Law; Jurisdiction; Arbitration.

(a) **Governing Law.** This Agreement and all claims arising hereunder or in connection herewith will be governed by and construed in accordance with the domestic substantive laws of the State of Delaware, without giving effect to any choice or conflict of law provision or rule that would cause the application of the domestic substantive laws of any other jurisdiction.

(b) **Jurisdiction.** Notwithstanding anything to the contrary herein, a party may apply to a court of competent jurisdiction for temporary or preliminary injunctive relief in connection with an arbitrable controversy, including, without limitation, in connection with any breach of a non-competition covenant, non-solicitation covenant or other restrictive covenant, and any such application shall not be deemed incompatible with or otherwise serve as a waiver of this Agreement. To the extent either party seeks to enforce an arbitration award pursuant to this Agreement, each of the parties irrevocably submits to the exclusive jurisdiction of any state or federal court sitting in New Castle County, Delaware.

(c) **Arbitration.** In the event a dispute arises among the parties hereto which the parties are unable to resolve themselves, then, upon written demand of a party, the matter or matters upon which the parties do not agree shall be first submitted to mediation in New Castle County, Delaware, in accordance with the rules of the American Arbitration Association ("AAA"). The parties shall use best efforts to schedule this mediation within thirty (30) days of the written demand. In the event that mediation is unsuccessful, as determined by the mediator, the dispute shall be settled by arbitration in New Castle County, Delaware, in accordance with the Commercial Arbitration or Employment rules of AAA (except for requests for injunctive relief, which may be made to any court of competent jurisdiction). Each party to this Agreement agrees to consider himself/herself bound and to be bound by any award or decision made by the arbitrators pursuant to this subsection. Any judgment on the award rendered by the arbitrator may be entered in any court of competent jurisdiction. The parties agree that the arbitrator shall award reasonable costs and attorney's fees to the prevailing party. The parties hereto and the arbitrator will maintain in confidence the existence of the arbitration proceeding, all materials filed in conjunction therewith and the substance of the underlying dispute unless and then only to the extent that disclosure is otherwise required by applicable law.

(d) **Reliance.** Each of the parties hereto acknowledges that he, she or it has been informed by each other party that the provisions of this Section 5.8 constitute a material inducement upon which such party is relying and will rely in entering into this Agreement and the transactions contemplated hereby.

5.9 Counterparts. The Parties may execute this Agreement in multiple counterparts, each of which will constitute an original and all of which, when taken together, will constitute one and the same agreement. The Parties may deliver executed signature pages to this Agreement by facsimile or email transmission. No Party may raise as a defense to the formation or enforceability of this Agreement, and each Party forever waives any such defense, either (a) the use of a facsimile, .pdf or email transmission to deliver a signature or (b) the fact that any signature was signed and subsequently transmitted by facsimile, .pdf or email transmission.

[SIGNATURE PAGE IMMEDIATELY FOLLOWS]

The Parties sign this Agreement on the date first above written.

THE COMPANY:

TIGO ENERGY, INC.

By: _____
Name: Zvi Alon
Title: Chief Executive Officer

[Signature Page to Restrictive Covenant Agreement]

RESTRICTED PARTY:

[]

By: _____

Name: []

Address for notices:

[ADDRESS]

[ADDRESS]

Email: []

[Signature Page to Restrictive Covenant Agreement]

ROTH CAPITAL PARTNERS, LLC
888 San Clemente Dr.
Newport Beach CA, 92660

CRAIG-HALLUM CAPITAL GROUP LLC
222 South Ninth Street, Suite 350
Minneapolis, MN 55402

December 5, 2022

Roth CH Acquisition IV Co.
888 San Clemente Drive, Suite 400
Newport Beach, CA 92660

Tigo Energy, Inc.
655 Campbell Technology Parkway, Suite 150
Campbell, CA 95008

To whom it may concern:

Reference is made to the business combination marketing agreement dated as of August 5, 2021 (the "Agreement"), by and among Roth CH Acquisition IV Co., a Delaware corporation ("Company") and Roth Capital Partners, LLC ("Roth") and Craig-Hallum Capital Group LLC (each an "Advisor" and together the "Advisors").

WHEREAS, the Company has entered into an agreement and plan of merger (the "Merger Agreement") with Tigo Energy, Inc. ("Tigo") and certain other parties thereto, pursuant to which the parties thereto have agreed to consummate a business combination and related transactions (the "Business Combination").

NOW, THEREFORE, the parties hereto, for good and valuable consideration which each party acknowledges the receipt of, hereby agree as follows:

- I. By signing below (i) the Company and the Advisors hereby mutually agree that the Agreement is hereby terminated and is no longer of any force or effect, (ii) each Advisor acknowledges that no amounts, fees or expenses are due to it by the Company pursuant to the terms of the Agreement, and (iii) the Company acknowledges that it has no claim against Advisors in connection with the termination of the Agreement. Notwithstanding the termination of the Agreement, the parties acknowledge that Article 5 and Annex I of the Agreement shall survive.
- II. In addition, the Company and Tigo mutually agree, jointly and severally, on the date of closing of the Business Combination, (y) to issue to Roth up to 300,000 shares of common stock of the post-Business Combination company in accordance with Schedule I hereto (the "Advisor Shares"), with such shares to be duly authorized and, when issued and delivered to Roth, validly issued, fully paid and non-assessable, and shall not have been issued in violation of or subject to any preemptive or similar rights created under the post-Business Combination company's organizational documents or applicable law or any other agreement or contract, and (z) to include the Advisor Shares issued pursuant to the foregoing clause (y) as a "Registrable Security" in that certain amended and restated registration rights agreement to be entered into upon the closing of the Business Combination.
- III. This termination agreement shall terminate and be of no force or effect if the Merger Agreement is terminated in accordance with its terms.

[Signature Page Follows]

Very truly yours,

ROTH CH ACQUISITION IV CO.

By: /s/ Byron Roth
Name: Byron Roth
Title: Co-Chief Executive Officer

TIGO ENERGY, INC.

By: /s/ Zvi Alon
Name: Zvi Alon
Title: Chief Executive Officer

By signing below, each of the parties below acknowledge and agree with the foregoing.

ROTH CAPITAL PARTNERS, LLC

By: /s/ Byron Roth
Name: Byron Roth
Title: Chief Executive Officer

CRAIG-HALLUM CAPITAL GROUP LLC

By: /s/ Steve Dyer
Name: Steve Dyer
Title: Chief Executive Officer

[Signature Page to Termination Agreement]

SCHEDULE 1

Advisor Share Issuance Based on Equity Raised

- I. In exchange for services rendered in connection with the proposed Business Combination, Roth shall be issued up to 300,000 Advisor Shares, equal to the Fixed Compensation Shares plus a number of Variable Compensation Shares equal to the product of (x) the quotient of Equity Raised divided by \$50.0 million, *multiplied* by (y) 200,000. For example, if Equity Raised equals \$31.5 million then total compensation would be the Fixed Compensation Shares plus 126,000 Variable Compensation Shares (calculated as \$31.5 million divided by \$50 million, multiplied by 200,000) for total Advisor Shares equal to 226,000. For the avoidance of doubt, Roth shall receive 100,000 Fixed Compensation Shares regardless of the amount of Equity Raised, if any.
- II. For purposes of Schedule I:
- a. the term "Equity Raised" means the gross proceeds available to the post-Business Combination Company immediately after the closing of the Business Combination, consisting of (a) the gross proceeds received from a capital raising transaction involving the equity securities or equity-linked instruments of Tigo and (b) the amount remaining in the Company's trust account after giving effect to any redemptions.
 - b. the term "Fixed Compensation Shares" means the 100,000 Advisory Shares issued to Roth in exchange for M&A advisory fees, regardless of the amount of Equity Raised.
 - c. the term "Variable Compensation Shares" means up to 200,000 shares issued to Roth based on the amount of Equity Raised.

[Schedule 1 to Termination Agreement]

Tigo Energy, Inc. to List on NASDAQ Through Business Combination with Roth CH Acquisition IV Co.

Tigo hardware and software solutions increase solar production, decrease operating costs, and enhance safety of residential, commercial, and utility-scale solar systems.

CAMPBELL, CALIF. & NEWPORT BEACH, CALIF., December 6, 2022 – Tigo Energy, Inc. (“Tigo”), a leading provider of intelligent solar and energy storage solutions, and Roth CH Acquisition IV Co. (NASDAQ: ROCG) (“Roth CH IV” or “ROCG”), a publicly-traded special purpose acquisition company with \$117 million held in trust, today announced the signing of a definitive agreement for a business combination that is expected to result in Tigo becoming a public company. Upon closing of the transaction, subject to approval by ROCG’s stockholders and other customary requirements, the combined company will be named “Tigo Energy, Inc.” (the “Company”) and is expected to list on NASDAQ under the ticker symbol “TYGO.” Current Tigo CEO and Chairman, Zvi Alon, will continue to lead the Company along with the current management team, and existing Tigo stockholders will roll 100% of their equity into the Company. The transaction is expected to close in the second quarter of 2023.

Tigo has served the solar energy industry with advanced power electronics since 2007; to date, it has secured a portfolio of 115 patents and shipped more than 10 million MLPE (Module Level Power Electronics) devices worldwide. With installations in over a hundred countries on all seven continents, Tigo systems generate more than 1 GWh of solar production daily. The Company’s products power everything from single-digit kilowatt residential systems to commercial, industrial, and utility systems, scaling to hundreds of megawatts on rooftop, ground-mounted, and floating applications.

For the commercial, industrial, and utility solar market segments, Tigo combines its Flex MLPE and solar optimizer technology with its cloud-based Energy Intelligence platform for advanced energy monitoring and control. Tigo MLPE products maximize performance, enable real-time energy monitoring, provide code-required rapid shutdown at the module level, and are UL-certified globally, and UL-system certified with hundreds of inverters from more than fifteen manufacturers. This open-platform approach gives Tigo customers significantly more freedom to right-size solar systems with the features and inverters they want.

For the residential solar and solar-plus storage market segments, Tigo develops and manufactures MLPE devices, inverters, battery storage systems, and related energy management hardware under the EI residential brand. The Tigo EI residential product portfolio is designed for ease-of-installation, more efficient system maintenance and management, and increased flexibility for installers. In combination with the Tigo EI mobile app and a browser-based program, the Tigo EI platform provides system diagnosis, over-the-air software upgrades, and energy production monitoring which serves both homeowners and installers.

Tigo Investment Highlights

- Substantial long-term demand prospects for solar and energy storage solutions across global residential, commercial, and utility markets
-

- Differentiated hardware and software products enhance safety, increase energy yield, and lower operating costs of solar systems, allowing for significant ROI to customers
- Capital-light business model with demonstrated operating leverage
- Continued strength in bookings growth with strong backlog into 2023
- Proven leadership team with public company experience

Transaction Overview

Pursuant to the business combination agreement, ROCG will acquire Tigo for a pre-money equity value of \$600 million. In connection with the transaction, ROCG will issue 60 million newly issued shares to current stockholders of Tigo (subject to any adjustment for capital raising transactions by Tigo prior to the closing).

Existing Tigo stockholders will not receive any cash proceeds as part of this transaction and will roll 100% of their equity into the Company. Assuming no ROCG stockholders exercise their redemption rights, gross proceeds of approximately \$117 million will be released to the Company from the trust account in connection with the transaction.

The boards of directors of Tigo and ROCG have unanimously approved the transaction. The transaction will require the approval of the stockholders of ROCG and is subject to other customary closing conditions. The transaction will also require the approval of the stockholders of Tigo by written consent or at a meeting of the stockholders of Tigo. The transaction is expected to close in the second quarter of 2023.

Upon closing of the transaction, Tigo's senior management will continue to serve in their current roles. Current Tigo stockholders will retain approximately 82% of the ownership at close of the Company, assuming no ROCG stockholders exercise their redemption rights.

Additional information regarding the proposed combination, including a copy of the business combination agreement and other relevant materials, will be provided by ROCG on a Current Report on Form 8-K filed with the U.S. Securities and Exchange Commission (the "SEC").

Advisors

White & Case LLP is acting as legal advisor to Tigo and both DLA Piper LLP and Loeb & Loeb LLP are acting as legal advisors to Roth CH IV.

About Tigo Energy, Inc.

Founded in 2007, Tigo is a worldwide leader in the development and manufacture of smart hardware and software solutions that enhance safety, increase energy yield, and lower operating costs of residential, commercial, and utility-scale solar systems. Tigo combines its Flex MLPE (Module Level Power Electronics) and solar optimizer technology with intelligent, cloud-based software capabilities for advanced energy monitoring and control. Tigo MLPE products maximize performance, enable real-time energy monitoring, and provide code-required rapid shutdown at the module level. The company also develops and manufactures products such as inverters and battery storage systems for the residential solar-plus-storage market. For more information, please visit <https://www.tigoenergy.com/>

About Roth CH Acquisition IV Co.

Roth CH Acquisition IV Co. is a blank check company incorporated for the purpose of effecting a merger, share exchange, asset acquisition, share purchase, reorganization or similar business combination with one or more businesses. Roth CH is jointly managed by affiliates of Roth Capital Partners and Craig-Hallum Capital Group. Its initial public offering occurred on August 5, 2021 raising approximately \$115 million. For more information, visit <https://www.rothch.com/>.

Additional Information and Where to Find It

This press release is provided for information purposes only and contains information with respect to a proposed business combination (the "Proposed Business Combination") among Tigo, Roth CH IV and Roth IV Merger Sub Inc., a wholly-owned subsidiary of Roth CH IV, in connection with the transactions contemplated in the business combination agreement. In connection with the Proposed Business Combination, Roth CH IV intends to file a registration on Form S-4, which will include a proxy statement to be sent to Roth CH IV stockholders and a prospectus for the registration of Roth CH IV securities in connection with the Proposed Business Combination (as amended from time to time, the "Registration Statement"). A full description of the terms of the Proposed Business Combination is expected to be provided in the Registration filed by Roth CH IV with the SEC. Roth CH IV urges investors, stockholders and other interested persons to read, when available, the Registration Statement as well as other documents filed with the SEC because these documents will contain important information about Roth CH IV, Tigo and Proposed Business Combination. If and when the Registration Statement is declared effective by the SEC, the definitive proxy statement/prospectus and other relevant documents will be mailed to stockholders of Roth CH IV as of a record date to be established for voting on the Proposed Business Combination. Stockholders and other interested persons will also be able to obtain a copy of the proxy statement, without charge, by directing a request to: Roth CH Acquisition IV Co., 888 San Clemente Drive, Suite 400, Newport Beach, CA 92660. The preliminary and definitive proxy statement, once available, can also be obtained, without charge, at the SEC's website (www.sec.gov). The information contained on, or that may be accessed through, the websites referenced in this press release is not incorporated by reference into, and is not a part of, this press release.

Forward Looking Statements

This communication contains forward-looking statements within the meaning of the Private Securities Litigation Reform Act of 1995 including, but not limited to, Roth CH IV's and Tigo's expectations or predictions of future financial or business performance or conditions. Forward-looking statements are inherently subject to risks, uncertainties and assumptions. Generally, statements that are not historical facts, including statements concerning our possible or assumed future actions, business strategies, events or results of operations, are forward-looking statements. These statements may be preceded by, followed by or include the words "believes," "estimates," "expects," "projects," "forecasts," "may," "will," "should," "seeks," "plans," "scheduled," "anticipates" or "intends" or similar expressions. Such forward-looking statements involve risks and uncertainties that may cause actual events, results or performance to differ materially from those indicated by such statements. Certain of these risks are identified and discussed in Roth CH IV's final prospectus for its initial public offering filed with the SEC on August 6, 2021 under the heading "Risk Factors." These risk factors will be important to consider in determining future results and should be reviewed in their entirety. These forward-looking statements are expressed in good faith, and Roth CH IV and Tigo believe there is a reasonable basis for them. However, there can be no assurance that the events, results or trends identified in these forward-looking statements will occur or be achieved. Forward-looking statements speak only as of the date they are made, and neither Roth CH IV nor Tigo is under any obligation, and expressly disclaim any obligation, to update, alter or otherwise revise any forward-looking statement, whether as a result of new information, future events or otherwise, except as required by law.

In addition to factors previously disclosed in Roth CH IV's reports filed with the SEC and those identified elsewhere in this communication, the following factors, among others, could cause actual results to differ materially from forward-looking statements or historical performance: (i) expectations regarding Tigo's strategies and future financial performance, including its future business plans or objectives, prospective performance and opportunities and competitors, revenues, products and services, pricing, operating expenses, market trends, liquidity, cash flows and uses of cash, capital expenditures, and Tigo's ability to invest in growth initiatives and pursue acquisition opportunities; (ii) the occurrence of any event, change or other circumstances that could give rise to the termination of the business combination agreement; (iii) the outcome of any legal proceedings that may be instituted against Roth CH IV or Tigo following announcement of the Proposed Business Combination and the transactions contemplated thereby; (iv) the inability to complete the proposed Merger due to, among other things, the failure to obtain Roth CH IV stockholder approval on the expected terms and schedule and the risk that regulatory approvals required for the merger are not obtained or are obtained subject to conditions that are not anticipated; (v) the risk that the proposed business combination or other business combination may not be completed by Roth CH IV's business combination deadline and the potential failure to obtain an extension of the business combination deadline (vi) the risk that the announcement and consummation of the proposed Merger disrupts Tigo's current operations and future plans; (vii) the ability to recognize the anticipated benefits of the proposed Merger; (viii) unexpected costs related to the proposed Merger; (ix) the amount of any redemptions by existing holders of the Roth CH IV Common Stock being greater than expected; (x) limited liquidity and trading of Roth CH IV's securities; (xi) geopolitical risk and changes in applicable laws or regulations; (xii) the possibility that Roth CH IV and/or Tigo may be adversely affected by other economic, business, and/or competitive factors; (xiii) operational risk; (xiv) risk that the COVID-19 pandemic, and local, state, and federal responses to addressing the pandemic may have an adverse effect on our business operations, as well as our financial condition and results of operations; and (xv) the risks that the consummation of the proposed Merger is substantially delayed or does not occur.

Any financial projections in this communication are forward-looking statements that are based on assumptions that are inherently subject to significant uncertainties and contingencies, many of which are beyond Roth CH IV's and Tigo's control. While all projections are necessarily speculative, Roth CH IV and Tigo believe that the preparation of prospective financial information involves increasingly higher levels of uncertainty the further out the projection extends from the date of preparation. The assumptions and estimates underlying the projected results are inherently uncertain and are subject to a wide variety of significant business, economic and competitive risks and uncertainties that could cause actual results to differ materially from those contained in the projections. The inclusion of projections in this communication should not be regarded as an indication that Roth CH IV and Tigo, or their representatives, considered or consider the projections to be a reliable prediction of future events.

Annualized, pro forma, projected and estimated numbers are used for illustrative purpose only, are not forecasts and may not reflect actual results.

The foregoing list of factors is not intended to be all-inclusive or to contain all the information that a person may desire in considering an investment in Roth CH IV and is not intended to form the basis of an investment decision in Roth CH IV. Readers should carefully review the foregoing factors and other risks and uncertainties described in the "Risk Factors" section of the Registration Statement and the other reports, which Roth CH IV has filed or will file from time to time with the SEC. There may be additional risks that neither Roth CH IV nor Tigo presently know, or that Roth CH IV and Tigo currently believe are immaterial, that could cause actual results to differ from those contained in forward looking statements. For these reasons, among others, investors and other interested persons are cautioned not to place undue reliance upon any forward-looking statements in this press release. All subsequent written and oral forward-looking statements concerning Roth CH IV and Tigo, the Proposed Business Combination or other matters and attributable to Roth CH IV and Tigo or any person acting on their behalf are expressly qualified in their entirety by the cautionary statements above.

Participants in the Solicitation

ROCG, Tigo and their respective directors and executive officers may be considered participants in the solicitation of proxies with respect to the Proposed Business Combination described herein under the rules of the SEC. Information about such persons and a description of their interests will be contained in the Registration Statement when it is filed with the SEC. These documents can be obtained free of charge from the sources indicated above.

No Offer or Solicitation

This communication does not constitute a proxy statement or solicitation of a proxy, consent, vote or authorization with respect to any securities or in respect of the Proposed Business Combination and shall not constitute an offer to sell or exchange, or a solicitation of an offer to buy or exchange any securities, nor shall there be any sale, issuance or transfer of any such securities in any state or jurisdiction in which such offer, solicitation or sale would be unlawful prior to registration or qualification under the securities laws of such state or jurisdiction. No offer of securities shall be made except by means of a prospectus meeting the requirements of Section 10 of the Securities Act of 1933, as amended, or an exemption therefrom.

Contact Information

[Roth CH Acquisition IV Co.](#)
RothCH@roth.com

[Tigo Energy, Inc.](#)
marketing@tigoenergy.com

Investor Presentation

Intelligent Solar and Energy Storage Solutions

December 2022

Tigo®



Disclaimer



Basis of Presentation

This Presentation (this "Presentation") is provided for informational purposes only and has been prepared to assist interested parties in making their own evaluation with respect to an investment in connection with a potential business combination between Tigo Energy, Inc. ("Tigo") and Roth CH Acquisition IV Co. ("Roth CH") and related transactions (the "Potential Business Combination") and for no other purpose. By accepting, reviewing or reading this Presentation, you will be deemed to have agreed to the obligations and restrictions set out below.

This Presentation and the information contained herein constitutes highly confidential information. The distribution of this Presentation by an authorized recipient to any other person is unauthorized. Any photocopying, disclosure, reproduction or alteration of the contents of this Presentation and any forwarding of a copy of this Presentation or any portion of this Presentation to any person is prohibited. The recipient of this Presentation shall keep this Presentation and its contents confidential, shall not use this Presentation and its contents for any purpose other than as expressly authorized by Tigo and Roth CH and shall be required to return or destroy all copies of this Presentation or portions thereof in its possession promptly following request for the return or destruction of such copies.

This Presentation may be deemed to be an offering of Roth CH or Tigo securities, made in reliance on an exemption from the registration requirements under the Securities Act of 1933, as amended and the securities laws of any other applicable jurisdiction, which exemptions apply to offers and sales of securities that do not involve a public offering. The market for any such securities may be illiquid and you may not be able to readily sell such securities. Investing in such securities would be speculative, involving a high degree of risk, and may result in the loss of the entire amount invested. Any such securities have not been approved or recommended by any federal, state or foreign securities authorities, nor have any of these authorities passed upon the merits of such an offering or determined that this Presentation is accurate or complete. Any representation to the contrary is a criminal offense.

No Offer or Solicitation

This Presentation and any oral statements made in connection with this Presentation do not constitute an offer to sell, or a solicitation of an offer to buy, or a recommendation to purchase, any securities in any jurisdiction, or the solicitation of any vote, consent or approval in any jurisdiction in connection with the Potential Business Combination or any related transactions, nor shall there be any sale, issuance or transfer of any securities in any jurisdiction where, or to any person to whom, such offer, solicitation or sale may be unlawful under the laws of such jurisdiction. This Presentation does not constitute either advice or a recommendation regarding any securities. No offering of securities shall be made except by means of a prospectus meeting the requirements of the Securities Act of 1933, as amended, or an exemption therefrom.

No Representations and Warranties

No representations or warranties, express, implied or statutory are given in, or in respect of, this Presentation, and no person may rely on the information contained in this Presentation. Any data on past performance or modeling contained herein is not an indication as to future performance. This data is subject to change. Recipients of this Presentation are not to construe its contents, or any prior or subsequent communications from or with Roth CH, Tigo or their respective representatives as investment, legal or tax advice. Each recipient should seek independent third party legal, regulatory, accounting and/or tax advice regarding this Presentation. In addition, this Presentation does not purport to be all-inclusive or to contain all of the information that may be required to make a full analysis of Tigo or the Potential Business Combination. Recipients of this Presentation should each make their own evaluation of Tigo and of the relevance and adequacy of the information and should make such other investigations as they deem necessary. Roth CH and Tigo assume no obligation to update the information in this Presentation. Each recipient also acknowledges and agrees that the information contained in this Presentation (i) is preliminary in nature and is subject to change, and any such changes may be material and (ii) should be considered in the context of the circumstances prevailing at the time and has not been, and will not be, updated to reflect material developments which may occur after the date of this Presentation. To the fullest extent permitted by law, in no circumstances will Tigo or Roth CH or any of their respective subsidiaries, stockholders, affiliates, representatives, partners, directors, officers, employees, advisers or agents be responsible or liable for any direct, indirect or consequential loss or loss of profit arising from the use of this Presentation, its contents, its omissions, reliance on the information contained within it or on opinions communicated in relation thereto or otherwise arising in connection therewith. This Presentation discusses trends and market data that Tigo's leadership team believes will impact the development and success of Tigo based on its current understanding of the marketplace.

Industry and Market Data

Industry and market data used in this Presentation have been obtained from third-party industry publications and sources as well as from research reports prepared for other purposes. Neither Roth CH nor Tigo has independently verified the data obtained from these sources and cannot assure you of the reasonableness of any assumptions used by these sources or the data's accuracy or completeness.



Disclaimer (cont'd)



Forward Looking Statements

Certain statements included in this Presentation are not historical facts but are forward-looking statements, including for purposes of the safe harbor provisions under the United States Private Securities Litigation Reform Act of 1995. Forward-looking statements generally are accompanied by words such as "believe," "may," "will," "estimate," "continue," "anticipate," "intend," "expect," "should," "would," "plan," "project," "forecast," "predict," "potential," "seem," "seek," "future," "outlook," "target," and similar expressions that predict or indicate future events or trends or that are not statements of historical matters, but the absence of these words does not mean that a statement is not forward-looking. These forward-looking statements include, but are not limited to, (1) statements regarding estimates and forecasts of other financial, performance and operational metrics and projections of market opportunity; (2) references with respect to the anticipated benefits of the Potential Business Combination and the projected future financial performance of Tigo following the Potential Business Combination; (3) changes in the market for Tigo's services and technology, and expansion plans and opportunities; (4) Tigo's unit economics; (5) the sources and uses of cash of the Potential Business Combination; (6) the anticipated capitalization and enterprise value of the combined company following the consummation of the Potential Business Combination; (7) the projected technological developments of Tigo; (8) current and future potential commercial and customer relationships; (9) the ability to operate efficiently at scale; (10) anticipated investments in capital resources and research and development, and the effect of these investments; (11) the amount of redemption requests made by Roth CH's public shareholders; (12) the ability of the combined company to issue equity or equity-linked securities in the future; and (13) expectations related to the terms and timing of the Potential Business Combination. These statements are based on various assumptions, whether or not identified in this Presentation, and on the current expectations of Roth CH's and Tigo's management and are not predictions of actual performance. These forward-looking statements are provided for illustrative purposes only and are not intended to serve as, and must not be relied on by any investor as, a guarantee, an assurance, a prediction or a definitive statement of fact or probability. Actual events and circumstances are difficult or impossible to predict and will differ from assumptions. Many actual events and circumstances are beyond the control of Tigo. These forward-looking statements are subject to a number of risks and uncertainties, as set forth in the slide entitled "Summary Risk Factors" in the appendix to this Presentation and those set forth in the section entitled "Risk Factors" and "Cautionary Note Regarding Forward-Looking Statements" in Roth CH's IPO prospectus, filed with the U.S. Securities and Exchange Commission (the "SEC") on August 6, 2021, and in those documents that Roth CH has filed, or will file, with the SEC. If any of these risks materialize or our assumptions prove incorrect, actual results could differ materially from the results implied by these forward-looking statements. The risks and uncertainties above are not exhaustive, and there may be additional risks that neither Roth CH nor Tigo presently know or that Roth CH and Tigo currently believe are immaterial that could also cause actual results to differ from those contained in the forward-looking statements. In addition, forward looking statements reflect Roth CH's and Tigo's expectations, plans or forecasts of future events and views as of the date of this Presentation. Roth CH and Tigo anticipate that subsequent events and developments will cause Roth CH's and Tigo's assessments to change. However, while Roth CH and Tigo may elect to update these forward-looking statements at some point in the future, Roth CH and Tigo specifically disclaim any obligation to do so. These forward-looking statements should not be relied upon as representing Roth CH's and Tigo's assessments as of any date subsequent to the date of this Presentation. Accordingly, undue reliance should not be placed upon the forward-looking statements.

Trademarks

Roth CH and Tigo own or have rights to various trademarks, service marks and trade names that they use in connection with the operation of their respective businesses. This Presentation also contains trademarks, service marks, trade names and copyrights of third parties, which are the property of their respective owners. The use or display of third parties' trademarks, service marks, trade names or products in this Presentation is not intended to, and does not imply, a relationship with Roth CH or Tigo, an endorser or sponsorship by or of Roth CH or Tigo, or a guarantee the Tigo or Roth CH will work or will continue to work with such third parties. Solely for convenience, the trademarks, service marks, trade names and copyrights referred to in this Presentation may appear without the TM, SM, ® or © symbols, but such references are not intended to indicate, in any way, that Roth CH, Tigo, or the any third-party will not assert, to the fullest extent under applicable law, their rights or the right of the applicable licensor to these trademarks, service marks, trade names and copyrights.

Financial Information; Non-GAAP Financial Measures

Some of the historical financial information contained in this presentation is unaudited and does not conform to Regulation S-X. Accordingly, such information and data may not be included in, may be adjusted in or may be presented differently in any proxy statement or registration statement to be filed by Roth CH with the SEC. In addition, financial information and data contained in this Presentation, such as Adjusted EBITDA, Adjusted EBITDA margin, and Adjusted EBITDA less Capital Expenditures, have not been prepared in accordance with United States generally accepted accounting principles ("GAAP"). Adjusted EBITDA is defined as net earnings (loss) before interest expense, income tax expense (benefit), depreciation and amortization, as adjusted to exclude stock based compensation. These non-GAAP financial measures, and other measures that are calculated using such non-GAAP measures, are an addition to, and not a substitute for or superior to, measures of financial performance prepared in accordance with GAAP and should not be considered as an alternative to revenue, operating income, profit before tax, net income or any other performance measures derived in accordance with GAAP. For the same reasons, Tigo is unable to address the probable significance of the unavailable information, which could be material to future results.

Roth CH and Tigo believe these non-GAAP measures of financial results, including on a forward-looking basis, provide useful information to management and investors regarding certain financial and business trends relating to Tigo's financial condition and results of operations. Tigo's management uses these non-GAAP measures for trend analyses, for purposes of determining management incentive compensation, and for budgeting and planning purposes. Roth CH and Tigo believe that the use of these non-GAAP financial measures provides an additional tool for investors to use in evaluating projected operating results and trends in and in comparing Tigo's financial measures with other similar companies, many of which present similar non-GAAP financial measures to investors. However, there are a number of limitations related to the use of these non-GAAP measures and their nearest GAAP equivalents. For example, other companies may calculate non-GAAP measures differently, or may use other measures to calculate their financial performance, and therefore Tigo's non-GAAP measures may not be directly comparable to similarly titled measures of other companies. See the Appendix for definitions of these non-GAAP financial measures and reconciliations of these non-GAAP financial measures to the most directly comparable GAAP measures.

Disclaimer (cont'd)



Use of Projections

This Presentation contains projected financial information with respect to Tigo, namely revenue, year-over-year growth, gross profit, gross profit margin, operating expenses, operating income (loss), Adjusted EBITDA, Adjusted EBITDA margin, capital expenditures, and Adjusted EBITDA less Capital Expenditures. Such projected financial information constitutes forward-looking information, and is for illustrative purposes only and should not be relied upon as necessarily being indicative of future results. The projections, estimates and targets in this Presentation are forward-looking statements that are based on assumptions that are inherently subject to significant uncertainties and contingencies, many of which are beyond Roth CH's and Tigo's control. See "Forward-Looking Statements" above. The assumptions and estimates underlying the projected, expected or target results are inherently uncertain and are subject to a wide variety of significant business, weather, economic, regulatory, competitive, technological, and other risks and uncertainties that could cause actual results to differ materially from those contained in such projections, estimates and targets. The inclusion of projections, estimates and targets in this Presentation should not be regarded as an indication that Roth CH and Tigo, or their representatives, considered or consider the financial projections, estimates and targets to be a reliable prediction of future events. Neither the independent auditors of Roth CH nor the independent registered public accounting firm of Tigo has audited, reviewed, compiled or performed any procedures with respect to the projections for the purpose of their inclusion in this Presentation, and accordingly, neither of them expressed an opinion or provided any other form of assurance with respect thereto for the purpose of this Presentation.

Important Information for Investors and Stockholders

In connection with a Potential Business Combination, Roth CH and Tigo are expected to prepare a registration statement on Form S-4 (the "Registration Statement") to be filed with the SEC by Roth CH, which will include preliminary and definitive proxy statement to be distributed to Roth CH's shareholders in connection with Roth CH's solicitation for proxies for the vote by Roth CH's shareholders in connection with the Potential Business Combination and other matters as described in the Registration Statement, as well as the prospectus relating to the offer of the securities to be issued to Tigo's shareholders in connection with the completion of the Potential Business Combination. After the Registration Statement has been filed and declared effective, Roth CH will mail a definitive proxy statement and other relevant documents to its shareholders as of the record date established for voting on the Potential Business Combination. Roth CH's shareholders and other interested persons are advised to read, once available, the preliminary proxy statement/prospectus and any amendments thereto and, once available, the definitive proxy statement/prospectus, in connection with Roth CH's solicitation of proxies for its special meeting of shareholders to be held to approve, among other things, the Potential Business Combination, because these documents will contain important information about Roth CH, Tigo and the Potential Business Combination. Shareholders may also obtain a copy of the preliminary or definitive proxy statement, once available, as well as other documents filed with the SEC regarding the Potential Business Combination and other documents filed with the SEC by Roth CH, without charge, at the SEC's website located at www.sec.gov or by directing a request to Roth CH Acquisition IV. Co., 888 San Clemente Drive, Suite 400, Newport Beach, CA 92660.

Roth CH and Tigo and their respective directors and executive officers, under SEC rules, may be deemed to be participants in the solicitation of proxies of Roth CH's shareholders in connection with the Potential Business Combination. Investors and security holder may obtain more detailed information regarding Roth CH's directors and executive officers in Roth CH's filings with the SEC, including Roth CH's Annual Report on Form 10-K filed with the SEC on March 30, 2022. Information regarding the persons who may, under SEC rules, be deemed participants in the solicitation of proxies to Roth CH's shareholders in connection with the Potential Business Combination, including a description of their direct and indirect interests, which may, in some cases, be different than those of Roth CH's shareholders generally, will be set forth in the Registration Statement. Shareholders, potential investors and other interested persons should read the Registration Statement carefully when it becomes available before making any voting or investment decisions.

This Presentation is not a substitute for the Registration Statement or for any other document that Roth CH may file with the SEC in connection with the Potential Business Combination. INVESTORS AND SECURITY HOLDERS ARE URGED TO READ THE DOCUMENTS FILED WITH THE SEC CAREFULLY AND IN THEIR ENTIRETY WHEN THEY BECOME AVAILABLE BECAUSE THEY WILL CONTAIN IMPORTANT INFORMATION. Investors and security holders may obtain free copies of other documents filed with the SEC by Roth CH through the website maintained by the SEC at <http://www.sec.gov>.

Changes and Additional Information in Connection with SEC Filings

The information in this Presentation has not been reviewed by the SEC and certain information, such as financial measures referenced herein, may not comply in certain respects with SEC rules. As a result, the information in the Registration Statement may differ from this Presentation to comply with SEC rules. The Registration Statement will include substantial additional information about Tigo and Roth CH not contained in this Presentation. Once filed, the information in the Registration Statement will update and supersede the information presented in this Presentation.

INVESTMENT IN ANY SECURITIES DESCRIBED HEREIN HAS NOT BEEN APPROVED OR DISAPPROVED BY THE SEC OR ANY OTHER REGULATORY AUTHORITY NOR HAS ANY AUTHORITY PASSED UPON OR ENDORSED THE MERITS OF THE POTENTIAL BUSINESS COMBINATION OR THE ACCURACY OR ADEQUACY OF THE INFORMATION CONTAINED HEREIN. ANY REPRESENTATION TO THE CONTRARY IS A CRIMINAL OFFENSE.



Proposed Transaction Summary

Tigo

A Rising Competitor in the Fast-Growing Solar & Energy Storage Market

The Business

- Tigo Energy, Inc. ("Tigo") is a leading provider of critical solar solutions that **improve safety, energy yield, & operating costs for solar**. Product offerings include **Module-Level** Power Electronics ("MLPE"), inverter, energy storage, and integrated energy management software

Transaction Overview

- Tigo and Roth CH Acquisition IV Co. ("ROCG") have executed a merger agreement to enter into a business combination (the "Transaction")
- Transaction expected to close in Q2 2023
- Upon the closing of the Transaction, Tigo will be a publicly listed company on Nasdaq under the new ticker TYGO

Valuation

- Pro forma Enterprise Value of \$599 million⁽¹⁾
- Pro forma Equity Value of \$730 million⁽¹⁾⁽²⁾

Capital Structure

- Tigo shareholders rolling 100% of their equity into ROCG
- Tigo has sufficient cash on the balance sheet today to fully fund its growth plan with proceeds from the transaction intended to further accelerate growth

Tigo Investors



1) Assumes no redemptions.

Today's Presenters

Tigo



Zvi Alon
Chairman & CEO



Bill Roeschlein
CFO



Byron Roth
Co-CEO & Executive
Chairman of the Board



John Lipman
Co-CEO & Director

What ROCG Likes About Tigo

Tigo stands to benefit significantly as it becomes a public company; in doing so, the company becomes a strong alternative to the current duopoly in the solar inverter market

- ✓ **Tigo provides a leading solar solution in a highly attractive category with significant tailwinds globally**
 - The passage of the Inflation Reduction Act ("IRA") in the US and energy dislocation in Europe have significantly accelerated solar demand
- ✓ **Tigo improves the economics of solar**
 - It improves energy output, ROI, and meets mandated safety requirements, all while representing a small percentage of the total installation cost
- ✓ **Solar installers are seeking additional suppliers**
 - Solar Optimizer and Inverter space is serviced by two prominent providers (ENPH and SEDG)⁽¹⁾
- ✓ **It is well positioned to capitalize on the opportunity**
 - Tigo has spent the last 15 years developing its solution

1) All comparisons in the Presentation are against Enphase and SolarEdge.



Tigo's Mission

Tigo's mission is to deliver smart hardware and software solutions that enhance **safety**, increase **energy yield**, and lower **operating costs** of residential, commercial, and utility-scale solar systems



Energy Intelligence (EI)





Investment Highlights

Higher ROI to Customers

Tigo offers lower cost systems with higher energy output, resulting in an immediate and more attractive ROI

Rapid 80%+ Y/Y Revenue Growth⁽¹⁾ in Large \$115B TAM

Gaining share in large and rapidly growing Solar and Energy Storage markets

30% Gross Margins⁽²⁾

Optimized architecture with low component count reduces cost base and increases product reliability

150+ Years of Combined Management Experience

Proven leadership team with public company experience

Growing Share

Solar Optimizer & Inverter space is serviced predominantly by two suppliers; customers are seeking multiple suppliers

400+ Customers

Diverse and expanding global customer base with substantial new wins

~\$4 Million 2022E Adj. EBITDA⁽³⁾

Capital-light business model

115 Patents⁽⁴⁾

Differentiated hardware and software solutions with significant entry barriers

1) 2022E Revenue Growth.
2) 2022E Gross Margin.
3) 2022E Adjusted EBITDA excludes stock-based compensation, M&A transaction and public company costs.
4) 115 patents includes both awarded (104) and pending (11) patents.

Market Overview



Solar and Storage: The Forefront of Renewables Expansion *Tigo*

Solar is expected to comprise over **40%** of new electricity-generating **capacity** additions in the U.S. in **2022**

Solar costs are expected to **decline 15-25%** over the next ten years

Solar is expected to be the cheapest form of electricity by 2030 and account for nearly **50% of renewables** generation by **2050**

Global energy **storage** is expected to **grow at a 30% CAGR** through **2030**

Rapid Improvement in Solar LCOE⁽¹⁾

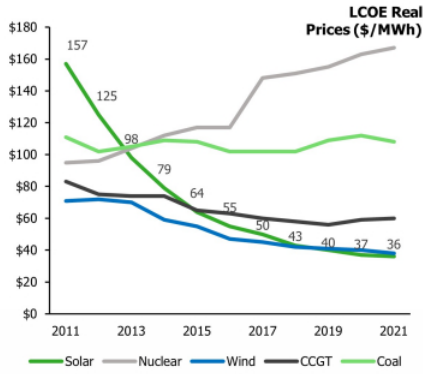

Rapid Storage Cost Reductions

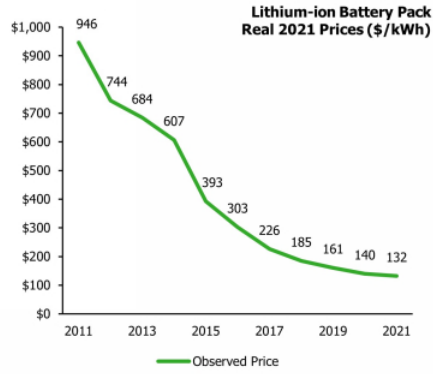

Significant Expected Growth in Solar and Storage

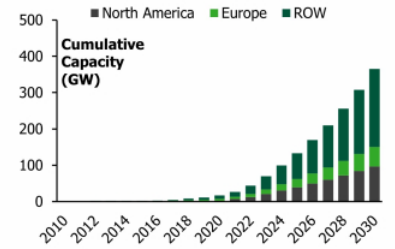
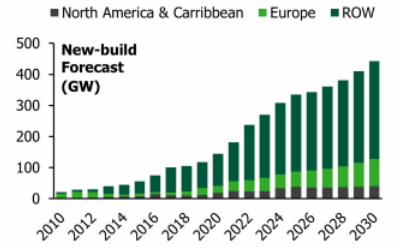

Sources: DOE, Greentech Media, Solar Energy Industries Association, BNEF, and Lazard LCOE Analysis 2022.
1) "LCOE" is defined as "Levelized Cost of Energy."

Solar and Storage: Europe Primed for Significant Growth

Higher Electricity Prices + Solar Market Growth = Residential Storage Demand in Europe

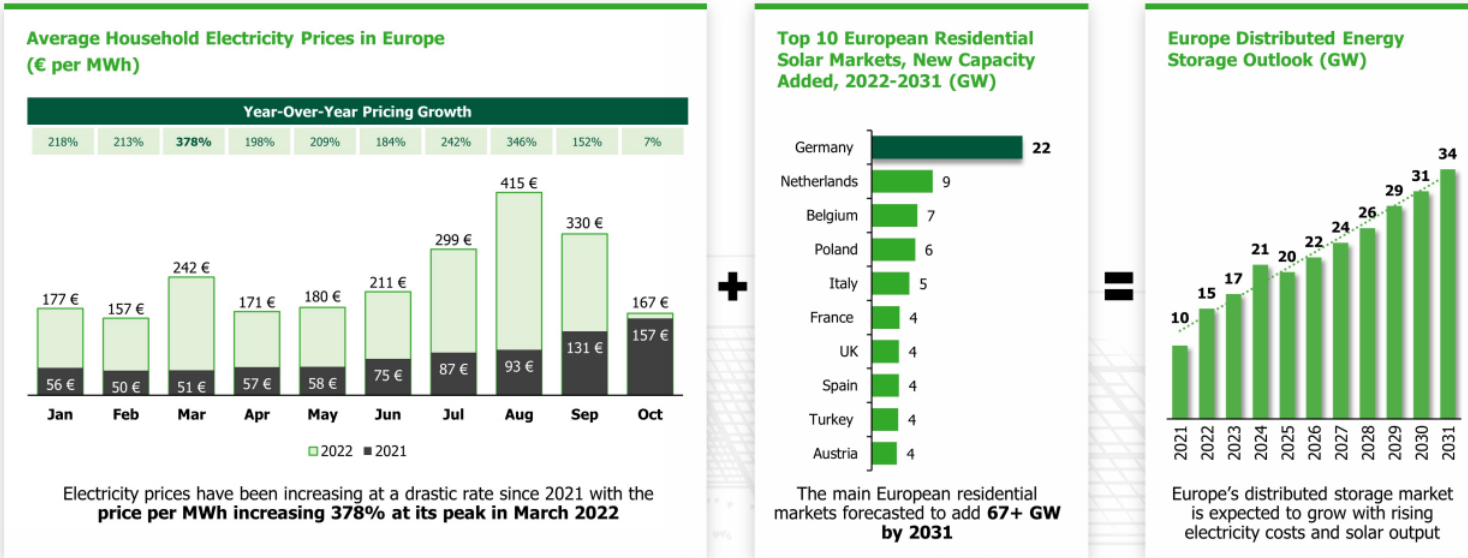

Europe is seeking alternative energy sources in its quest for energy independence: Solar is a logical answer

Source: Ember Climate November 2022, Wood Mackenzie Europe Distributed Energy Storage Outlook 2022.

Solar and Storage: US Primed for Significant Growth

The 2022 extension of the Investment Tax Credit ("ITC"), Production Tax Credit ("PTC"), and the Advanced Manufacturing Production Credit ("AMPC") provides stability and investment opportunity for solar and storage energy within the United States.

Key Stats

ITC & PTC

30%

Tax credit residents installing solar systems

+10-20%

"Adder" ITC for USA content and development in certain low-income communities

10-year

Extension of full PTC / ITC values to at least 2032

AMPC

\$0.11

per AC watt for domestic manufacturing of **microinverters**

\$0.065

Advanced Manufacturing Tax Credit for Residential Inverters

Source: Enphase earnings call, SEIA Inflation Reduction Act Summary Report, Norton Rose Fulbright Project Finance Law.

TAM is Estimated to Be \$115 Billion by 2025



1) Source: IHS Markit Solar PV Inverter Market Overview.
2) Source: SolarEdge March 29, 2022 Analyst Day, Stem Inc., May 23, 2021.



Tigo Business Overview





Tigo Makes Solar Energy Better

Tigo's Module-Level Power Electronics ("MLPE") and Energy Intelligence ("EI") Solution **improve the safety, energy yield, and cost** of solar across **all three end markets (Residential, C&I, and Utility)**.



Europe and the US are Key Drivers of Growth

Energy costs are rising rapidly in Europe and the supply chain is less impacted by solar specific trade actions. As a result, **Tigo is gaining traction** in the region, accounting for **61% of YTD Q3 2022A revenue and 74% of Q3 2022 order book**. **The passage of IRA is expected to further enhance growth in the US.**



Market Share Gains

Tigo offers a **higher ROI for solar customers**, and as a result, is winning share in both Europe and the US, having **recently won two significant Approved Vendor Lists**. Tigo believes it is **well positioned to gain market share** in a rapidly growing market.



Cutting Edge Storage & Energy Intelligence Software Offerings

New EI storage product and internal software development have and are expected to continue to **increase bookings and Annual Recurring Revenue ("ARR")**. In Q4 2022, Tigo will launch EI in Europe and is expected to further accelerate growth.



Asset-light & Resilient Supply Chain

Tigo leverages an asset-light approach through contract manufacturing with a substantial presence in Asia and planned addition in Eastern Europe, allowing the company to **scale rapidly with minimal CapEx**.

Select Customers & Partners



Key Highlights

\$80M

2022E Revenue

\$4M

2022E Adj. EBITDA

31% | 61% | 8%

YTD Sep 2022A Revenue
NA | EMEA | ROW⁽¹⁾

<0.01%

Product Returns in the
Last Three Years

1) "NA | EMEA | ROW" refers to North America; Europe, Middle East and Africa; and Rest of World, respectively.

Tigo MLPE and Energy Storage Solutions



Tigo Bundles Proprietary Hardware and Software Into an Easy-to-Use Platform



Illustrative Diagram of Tigo Solutions

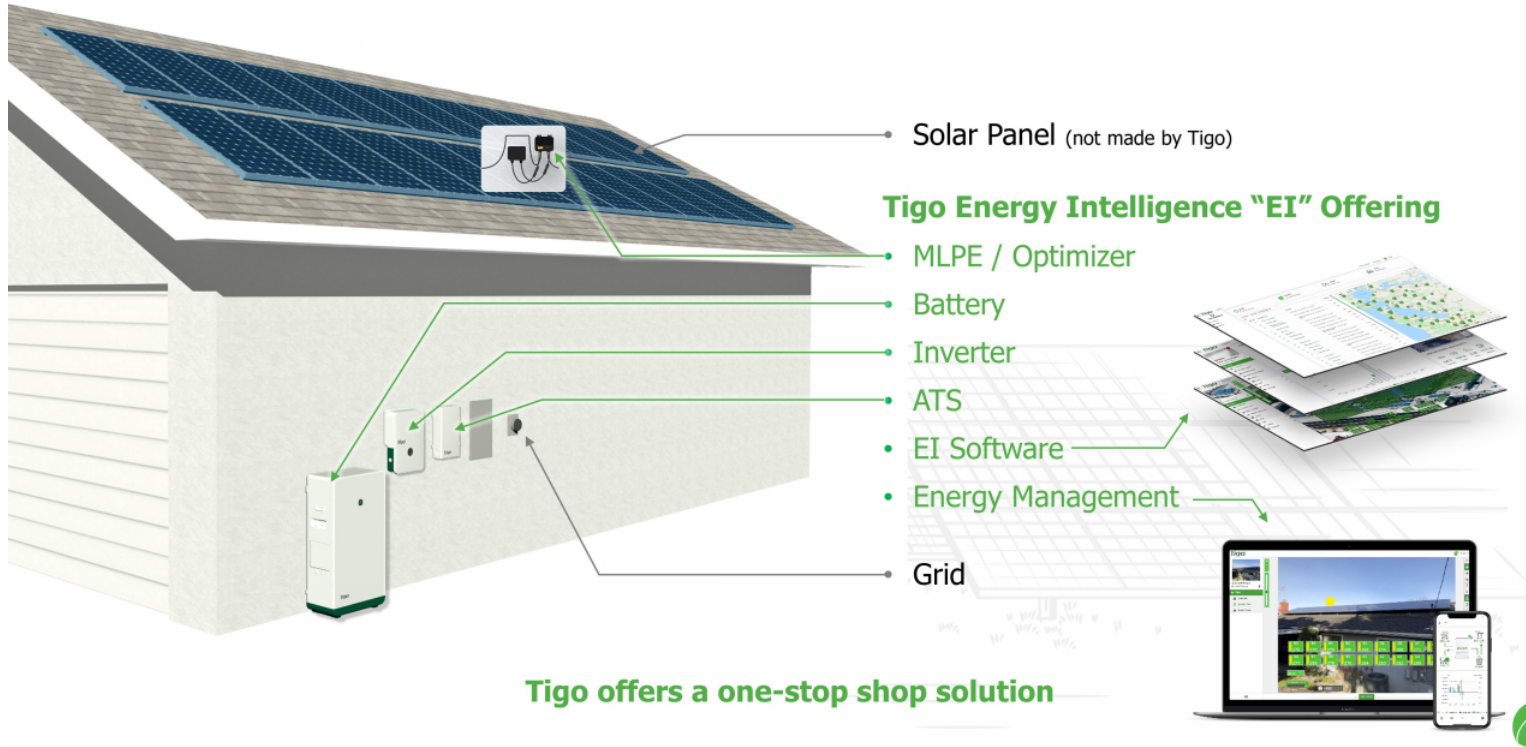

Tigo MLPE Serves All Three Solar Markets

Performance Optimization | Increase Energy Output

Tigo optimizers increase energy output from solar panels and decrease the losses from shading, module mismatch, degradation, and soiling



Safety | Enhance Safety & Compliance

Tigo solutions meet US NEC Rapid Shutdown regulatory compliance and other safety codes that protect first responders and are required in many countries



Visibility & Monitoring | Lower Operating Expenses

Tigo gives customers granular, module-level monitoring with its Energy Intelligence Platform. It identifies anomalies at the module level, increases bankability, and lowers maintenance expenses



Residential



Commercial



Utility



Tigo's Family of MLPE Solutions

Five MLPE Features Cater to All Solar End Markets



TS4-A-M

Functions

- Monitoring

Equipment Required

- CCA + TAP⁽¹⁾

Description

- Enables module-level monitoring



TS4-A-F

Functions

- Rapid Shutdown

Equipment Required

- RSS Transmitter⁽¹⁾

Description

- Dedicated rapid shutdown device for one solar module up to 700W



TS4-A-2F

Functions

- Rapid Shutdown for two panels

Equipment Required

- RSS Transmitter⁽¹⁾

Description

- Dedicated rapid shutdown device for two solar modules



TS4-A-S

Functions

- Monitoring
- Rapid Shutdown

Equipment Required

- CCA + TAP⁽¹⁾

Description

- Enables monitoring and rapid shutdown for modules up to 700W



TS4-A-O

Functions

- Optimization
- Monitoring
- Rapid Shutdown

Equipment Required

- CCA + TAP⁽¹⁾

Description

- Increase energy production with shaded & mismatched modules up to 700W⁽²⁾

Price & Functionality

1) CCA is defined as Cloud Connect Advanced data logger. TAP is defined as Tigo Access Point. RSS is defined as Rapid Shutdown System.
2) Includes monitoring and rapid shutdown benefits as well.

Tigo's Energy Intelligence Solution



Through EI and its integrated software / analytics, Tigo aims to tackle one of the **largest opportunities in the solar ecosystem: energy storage & management**



EI is **applicable to** both the **residential** and **C&I** markets



EI is an extension of Tigo's existing core competency, and **leverages existing go-to-market channels to achieve success**

Energy Intelligence Hardware



Tigo Inverter



Tigo Battery



Tigo MLPE

- Tigo MLPE and Tigo cloud-enabled inverter with proprietary technology
- Tigo DC-coupled battery system
- Provides energy savings over traditional AC- coupled storage systems⁽¹⁾

Software and Analytics



Building Loads

System Monitoring

- Integrated energy management system
- Expanded premium monitoring and Operations & Maintenance ("O&M") solutions

EI provides holistic energy management capability, incorporating efficient DC-coupled storage integration and intelligent monitoring solutions

1) See comparison on page 46.

Tigo's Software and Analytics Offering

Software and Analytics platform provides a holistic energy management capability, powered by module-level monitoring and machine learning

R Residential **C** C&I **U** Utility

Software: Origination/Design

- Site Assessment
- Design / Proposal
- Permitting / Code Compliance
- Construction Documents

R C

Analytics: Energy Management

- System Optimization
- Virtual Power Plant
- Grid Services

R C U

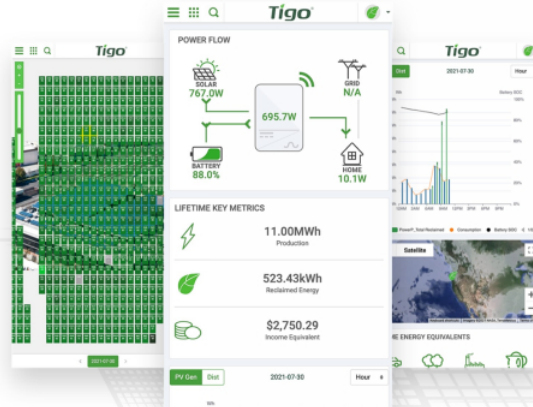

Software: Premium Monitoring

- Real-time Data Acquisition
- Site Monitoring
- Production, Communication Alerts
- Portfolio Management

R C U

Analytics: Operations & Maintenance







- Production Analytics
- Remote Diagnosis
- Production Degradation
- Preventive Alerts

R C U

900+ TB

of data on solar system performance collected to date

Technology Advantages

115 Patents⁽¹⁾ 	Patent-protected technology moat driven by strong R&D and culture of innovation
Selective Optimization & Deployment 	Selective optimization uses less energy and increases reliability vs. competitors' constant optimization; selective deployment permits use of optimizers only on panels where it is needed and lowers cost vs. peers that require optimizers on 100% of panels
Superior Energy Storage Architecture 	DC-coupled architecture delivers higher "round-trip" energy savings at a lower cost vs. competitors' AC-coupled architecture
Compatibility 	Unlike competitors' closed architectures (working only within their own family of products), Tigo's open MLPE architecture works with any string inverter, any module, and is uniquely compatible with today's higher-power modules
Software & Analytics 	Platform provides holistic energy management capability, powered by module-level monitoring and machine learning
High Reliability 	Lower component count and higher MLPE efficiency produce less heat, resulting in <math><0.01\%^{(2)}</math> product returns

Tigo possesses key competitive advantages on price, performance, and flexibility

1) 115 patents includes both issued (104) and pending (11) patents.
2) Company figures for the last three years.

Years of Research, Development, Testing and Certification Tigo Have Created a Strong Competitive Position

Hardware Advantages

- **Cost effective:** Decades of experience designing solutions that minimize cost without compromising quality
- **High MLPE Efficiency:** 99.7%
- **Manufacturable:** Low component count, no custom Application-Specific Integrated-Circuits ("ASICs")
- **Market-oriented and flexible:** Strong pulse on changes in solar industry, and addressing its needs

Software Advantages

- **Modular:** Reusable
- **Robust:** Software development guidelines are based on toughest standards (MISRA)⁽²⁾
- **Maintainable:** Modular design, well-thought architecture, and high-standards of coding style
- **Supportable:** Remote diagnostics, self-service, and remote upgrades
- **Efficient:** Faster software reduces the need for expensive hardware

Patent Categories

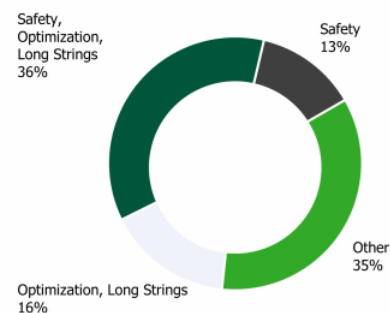

Tigo is uniquely positioned for today's higher-power modules

Year	MLPE Capacity
2007	150W
2012	200W
2022	700W+

Tigo's 115⁽¹⁾ patents confer a substantial competitive advantage

1) 115 patents includes both issued (104) and pending (11) patents.
2) MISRA refers to Motor Industry Software Reliability Association.

Resilient Supply Chain

Tigo has secured sufficient components and production capacity to meet forecasted demand through 2023E

- 1 Contract Manufacturers**
Multi-sourced, flexible, and scalable contract manufacturers in Asia
- 2 Manufacturing Capacity Expansion**
Tigo seeks to expand contract manufacturing capabilities in the US and/or Eastern Europe/Northern Africa
- 3 Streamlined Product Line**
Tigo has just eight SKUs⁽¹⁾ to service the entire market
- 4 Lower Component Count**
Tigo MLPE has fewer components thus streamlining component purchases
- 5 No Custom Application-Specific Integrated-Circuits**
Tigo not reliant on custom ASICs, which have been a primary bottleneck for competitors

1) SKU is defined as Stock Keeping Unit.
2) Tigo management estimates corresponding with financial model.

Expected MLPE Capacity & Utilization⁽²⁾

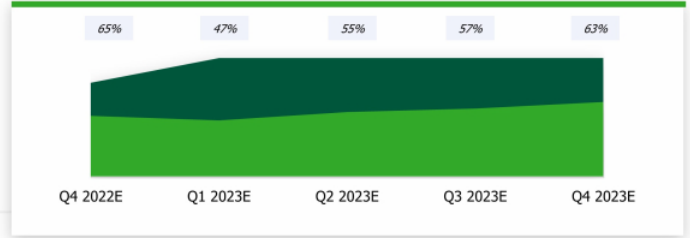

Expected Energy Intelligence Capacity & Utilization⁽²⁾

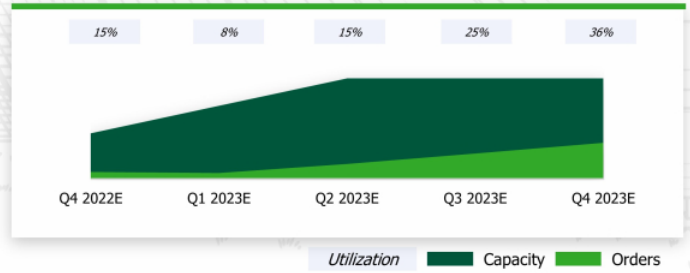

Utilization Capacity Orders

Why Customers Choose Tigo



Tigo Offers Lower Cost Systems with Higher Energy Output, Resulting in an Immediate and More Attractive ROI



Complete one-stop solution



- Rapid Shutdown
- Module-level monitoring software
- Hybrid Inverter
- ATS
- Battery Storage
- Software & Analytics

Improved PV performance, energy yield, & reliability



- Increased energy yield through selective optimization
- High reliability supported by lower component count and higher MLPE efficiency resulting in less heat
- Low product returns
- Industry leading warranty

Lower initial investment & ongoing O&M costs



- Only pay for optimization where needed (i.e. selective optimization)
- Lower O&M cost
- Lower inverter cost
- Lower battery cost
- Works with any standard inverter

Easy to install



- Mobile app commissioning
- 10 seconds per module
- Continuous online educational training
- No ground wire required
- Water- and corrosion-resistant
- Seamless integration between modules and battery devices

Tigo Compares Favorably Against Peers

- MLPE + Inverter Price⁽¹⁾

- MLPE
 - Low Component Count
 - Flexibility: Works with multiple inverters
 - Selective Optimization & Deployment
 - End Market Coverage

- Inverter Architecture⁽³⁾

- Compatible w/ Lower Cost Battery Chemistries⁽⁴⁾

- Software/Analytics Offering

	Tigo	ENPHASE	solaredge
MLPE + Inverter Price ⁽¹⁾	~17-19¢/watt	~37-38¢+/watt ⁽²⁾	~33-34¢/watt ⁽²⁾
MLPE	✓	✗	✗
Low Component Count	✓	✗	✗
Flexibility: Works with multiple inverters	✓	✗	✗
Selective Optimization & Deployment	✓	✗	✗
End Market Coverage	Residential, C&I, and Utility	Residential	Residential and C&I
Inverter Architecture ⁽³⁾	Open: DC-Coupled	Closed: AC-Coupled	Closed: DC-Coupled
Compatible w/ Lower Cost Battery Chemistries ⁽⁴⁾	✓	✗	✗
Software/Analytics Offering	✓	✓	✓

1) Prices reflect MLPE and inverters in the residential market.
 2) Enphase, SolarEdge, Wall Street Equity Research.
 3) Open and Closed refers to the ability to work with other components outside their own family of products including ATS, inverter, and battery module.
 4) Compatible with all current battery chemistries including Lithium Iron Phosphate (LFP).

Strong Leadership Team to Drive Growth

150+ years of combined management experience



Zvi Alon
Chairman and CEO
30+ years experience



Bill Roeschlein
Chief Financial Officer
20+ years experience



JD Dillon
Chief Marketing Officer
20+ years experience



Jing Tian
Chief Growth Officer
20+ years experience



Anita Chang
Chief Operations Officer
20+ years experience



Archie Robostoff
Vice President of Software
20+ years experience



Danny Eizips
Vice President of Engineering
20+ years experience



Financial Overview



Financial Summary and Forecast

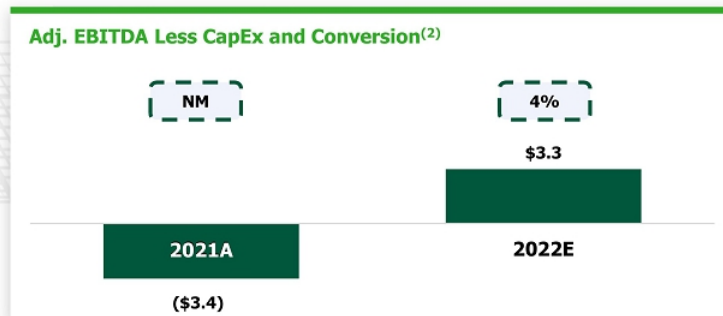
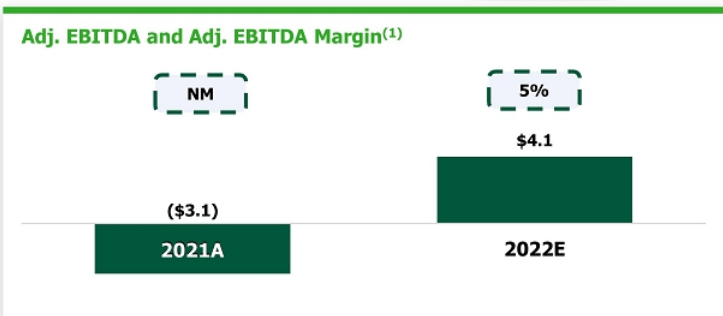
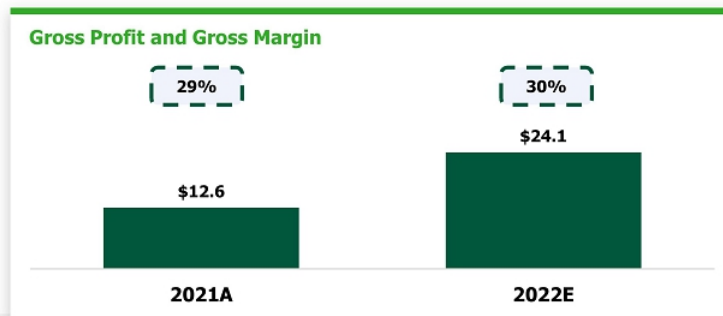
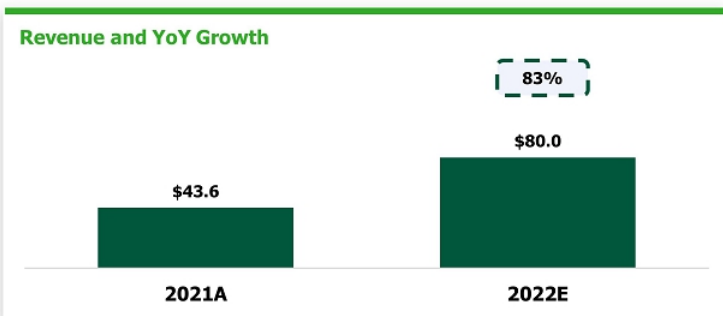

Note: All figures presented in millions of US dollars. A reconciliation of non-GAAP metrics is provided in the Appendix.
 1) Adjusted EBITDA excludes stock-based compensation, M&A transaction expenses and public company costs.
 2) Conversion defined as Adjusted EBITDA less capital expenditures divided by Adjusted EBITDA.

Strong Bookings & Backlog Provide Meaningful Visibility

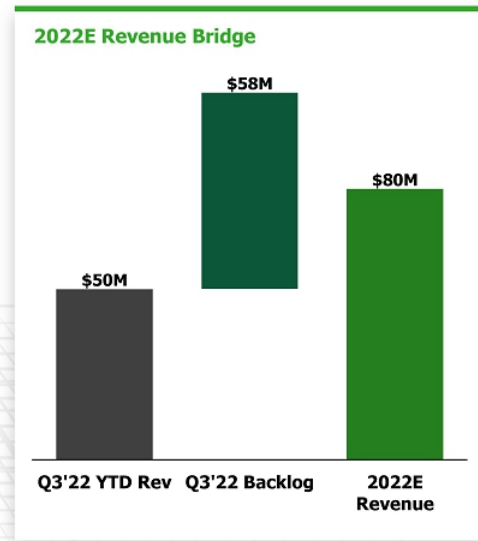
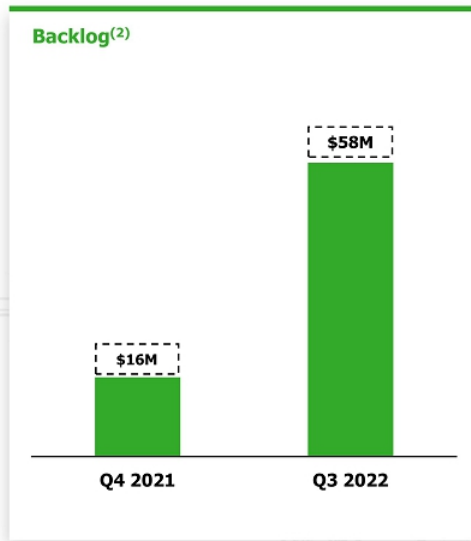
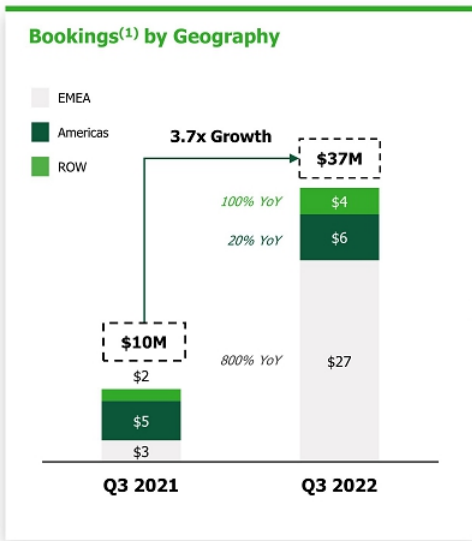

Tigo is experiencing rapid expansion across geographies, providing strong revenue visibility

1) Bookings defined as new purchase orders received in a given period.
 2) Backlog defined as cumulative purchase orders not yet delivered but expected to be within 365 days.



YTD Q3 2022A Revenue by Customers

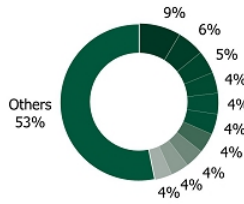

YTD Q3 2022A Revenue by Geography

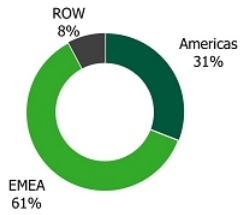

Distributors



New Customers / Partners



Key Accounts



Inverters & Panels Partners



Tigo aims to expand business with existing and new customers / partners

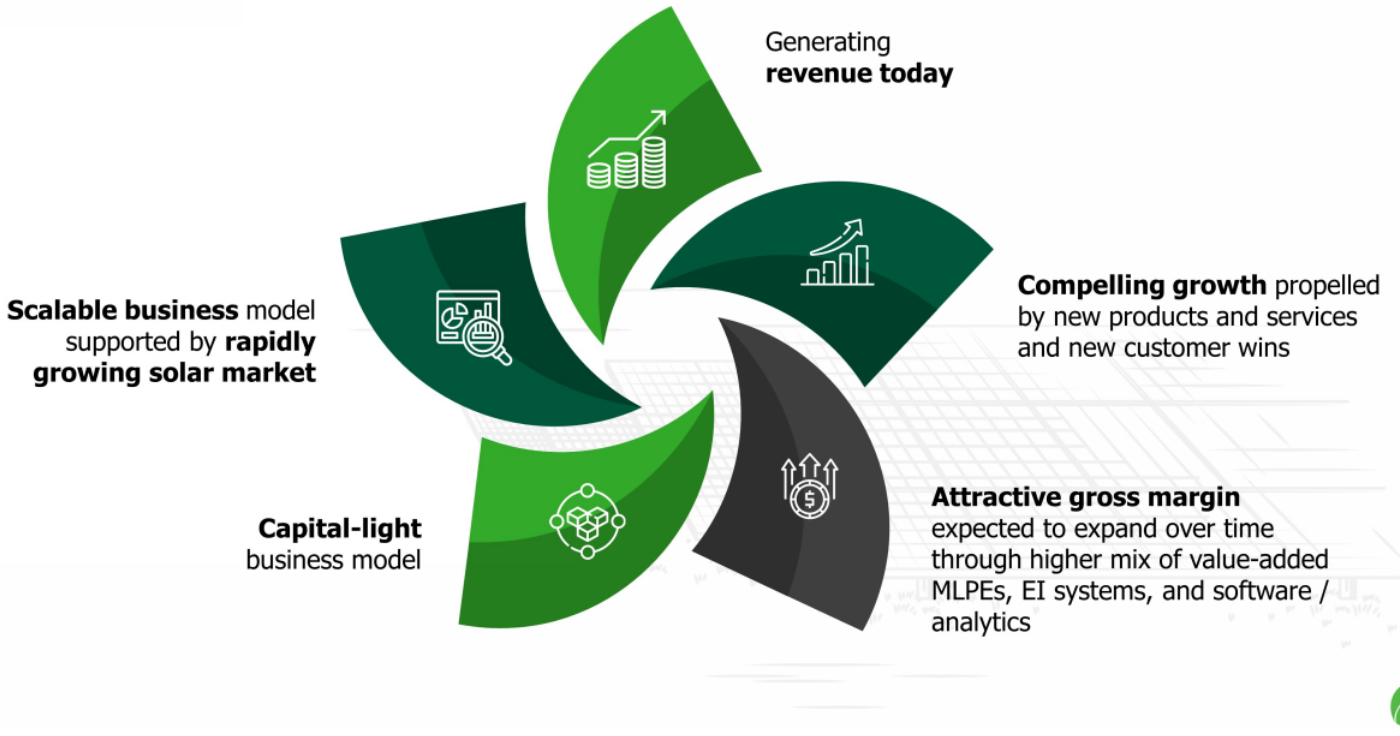

Transaction Summary



Detailed Transaction Overview

Sources and Uses

(\$ in millions, except per share values)

Sources

SPAC Cash in Trust ⁽¹⁾	\$117
Stock Consideration to Existing Tigo Shareholders ⁽²⁾	600
Total Sources	\$717

Uses

Stock Consideration to Existing Tigo Shareholders ⁽²⁾	\$600
Cash to Tigo Balance Sheet at Closing ⁽¹⁾	110
Estimated Fees and Expenses	7
Total Uses	\$717

Pro Forma Valuation

(\$ in millions, except per share values)

Pro Forma Shares Outstanding ⁽¹⁾⁽²⁾⁽³⁾⁽⁴⁾	73.0
(*) Share Price	10.00
Equity Value	\$730
(+) Existing Debt as of 09/30/2022	20
(-) Existing Cash as of 09/30/2022	(42)
(-) Cash Proceeds from Transaction	(110)
Enterprise Value	\$599

Pro Forma Ownership

Ownership Breakdown at Close⁽¹⁾⁽³⁾

	Shares	% Ownership
Tigo Rollover ⁽²⁾	60.0	82.2%
ROCG Public Shareholders	11.5	15.7%
ROCG Sponsor Shareholders ⁽⁴⁾	1.2	1.7%
Transaction Fees ⁽⁵⁾	0.3	0.4%
PF Shares Outstanding	73.0	100%

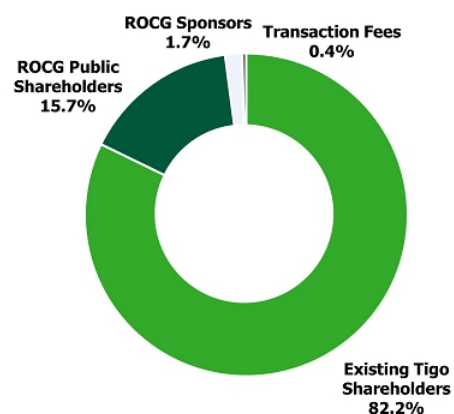





- 1) Assumes no redemptions from ROCG's existing public shareholders.
- 2) \$578 Enterprise Value + \$42 existing cash - \$20 existing debt as of 09/30/2022 presented for illustrative purposes. Cash and debt as of the closing date will be used to calculate the stock consideration to existing Tigo shareholders.
- 3) Ownership and share count excludes 5.98 million outstanding ROCG warrants (strike price of \$11.50 or 15% out-of-the-money)
- 4) Includes existing ROCG Founder shares net a 1.65 million share forfeiture.
- 5) Transaction fees of up to 300,000 shares related to the BCMA Termination Letter.

Market Dynamics

-  Tigo is experiencing strong demand, and customers are asking for deeper integration with Tigo MLPE, inverter, and storage systems
-  Large solar companies prefer working with well-capitalized and public vendors
-  Skilled labor remains tight; public stock currency can help attract, retain, and incentivize top talent
-  Given supply chain dislocation, certain components need to be ordered up to one year in advance, requiring working capital
-  Interest rates are rising, and public companies have better access to lower cost capital
-  Shares of publicly traded residential inverters and MLPE companies have outperformed the broader market, viewed as unit play on the growth of solar
-  Tigo believes it can obtain a rapidly growing share amongst top solar customers

Expected Use of Proceeds

-  Expand sales reach to address growing demand
-  Accelerate new product launches
-  Expand and de-risk manufacturing and supply chain and invest in critical working capital where product availability and on-time delivery provide a significant competitive advantage and the ability to gain market share
-  Improve balance sheet & working capital (i.e., bankability, shorten customer delivery times)
-  Pursue select strategic acquisitions

Public Comparable Universe

Solar Optimizers and Inverters

The Tigo logo is displayed in a light blue rounded rectangular box. It features the word "Tigo" in a green, sans-serif font, with a small green leaf icon above the letter 'i'.The Enphase logo is displayed in a light blue rounded rectangular box. It consists of an orange circle with a white horizontal line through it, followed by the word "ENPHASE" in a bold, black, sans-serif font.The SolarEdge logo is displayed in a light blue rounded rectangular box. It features the word "solar" in a black, lowercase, sans-serif font, followed by "edge" in a red, lowercase, sans-serif font.

Attributes of Comp Universe

- Comparable product and service offerings to Tigo
- Module-level power electronics and inverters as well as software (analytics / monitoring) focused on solar deployment
- Serve similar end markets



Two Companies Dominate the US Residential Solar Inverter *Tigo* Market; Customers Seek Additional Suppliers⁽¹⁾

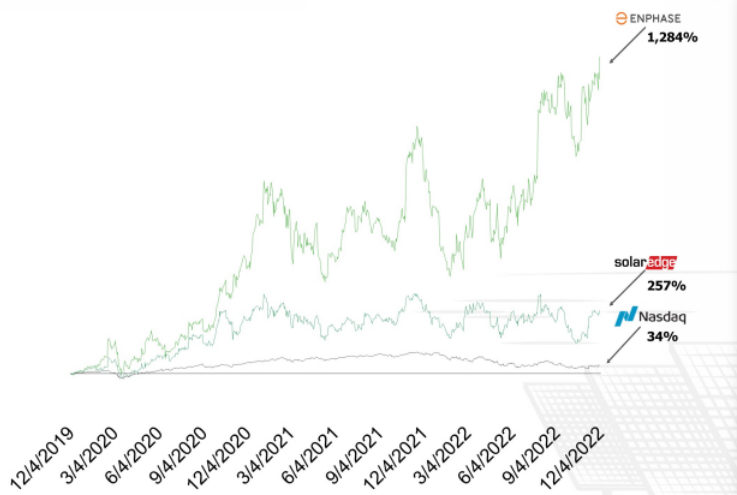

Key Takeaways

- SEDG and ENPH **increased** by **257%** and **1,284%** respectively in the last three years
- SEDG and ENPH **increased 10%** and **84%**, respectively, YTD 2022 versus the Nasdaq which **declined 27%** over the same time period leading to outperformance of **37%** and **111%**
- Residential inverters have outperformed the broader market, viewed as unit play on the growth of solar

Peers' stock price performance highlights the market's focus on US Residential Solar. Tigo believes it can gain market share in the US Residential Solar Inverter market, because it offers solar customers a lower cost system with higher energy output, resulting in an immediate and more attractive ROI

Source: S&P Capital IQ as of 12/02/2022.
1) Tigo management estimates.

Revenue YoY Growth (2021-2022E)

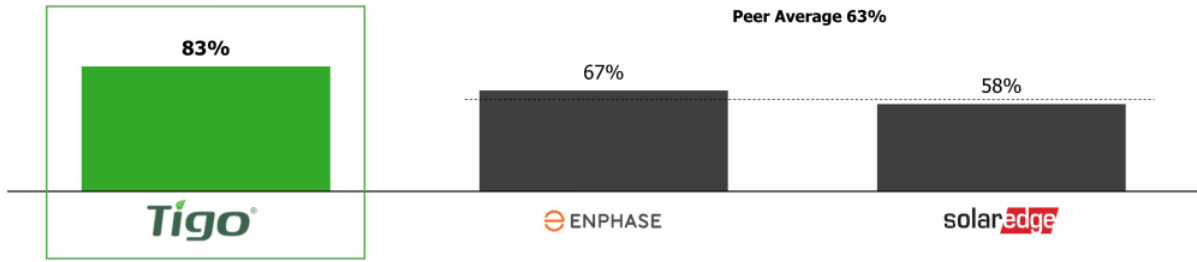

2021 & 2022E Gross Margin

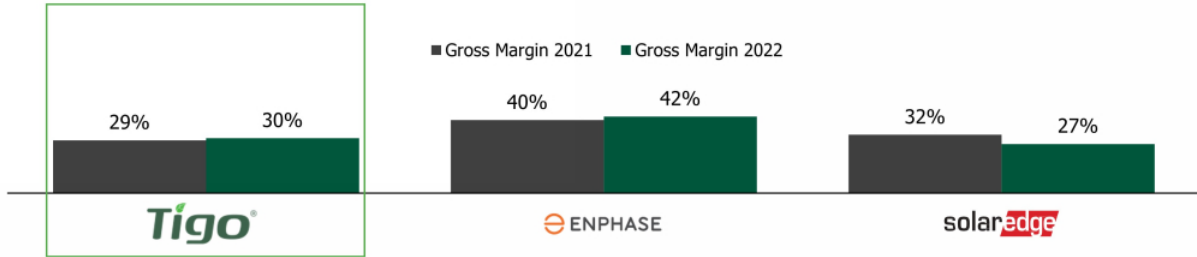

Source: S&P Capital IQ as of 12/02/2022.

EV/2022E Revenue

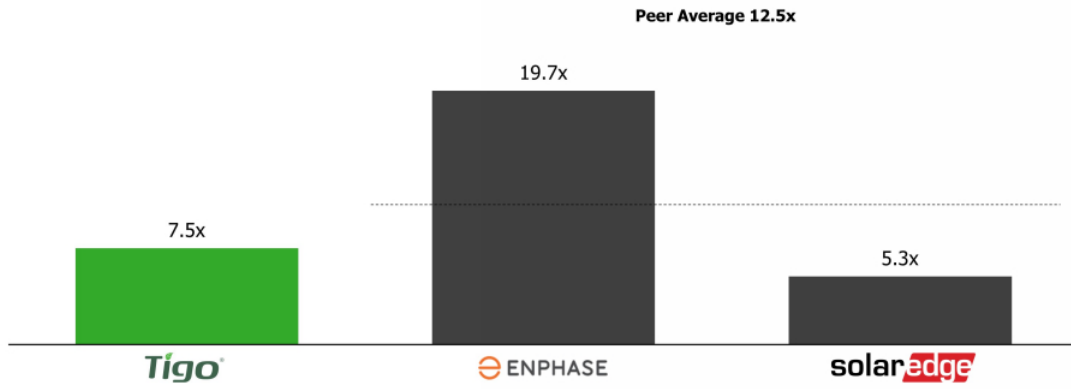

Sources: Company projections and S&P Capital IQ as of 12/02/2022.

Conclusions



Large and Growing TAM



Significant Technology Barriers



Global, Diversified, and Expanding Customer Base



Tigo Offers Customers a Lower Cost and Higher ROI



Increasing Manufacturing Scale



Deep and Experienced Management Team



Winning Share from Incumbent Providers



Risk Factors



Risk Factors



All references to the "Company," "we," "us" or "our" refer to Tigo. The risks presented below are certain of the general risks related to the business of the Company and such list is not exhaustive. The list below has been prepared solely for purposes of inclusion in this Presentation and not for any other purpose. You should carefully consider these risks and uncertainties, together with the information in the Company's consolidated financial statements and related notes. Risks relating to the business of the Company will be disclosed in future documents filed or furnished by the Company and/or ROCG with the SEC. The risks presented in such filings will be consistent with those that would be required for a public company in their SEC filings, including with respect to the business and securities of the Company and may differ significantly from, and be more extensive than, those presented below.

Risks Related to Our Business and Our Industry

- We have a history of generating net losses, and if we are unable to achieve adequate revenue growth while our expenses increase, we may not achieve or maintain profitability in the future.
- Demand for our solar energy solutions may not grow or may grow at a slower rate than we anticipate and our business may suffer.
- The rapidly evolving and competitive nature of the solar industry makes it difficult to evaluate our future prospects. Our entry into adjacent markets is new and highly competitive and it is difficult to evaluate our future in these new markets as well.
- Developments in alternative technologies or improvements in other forms of distributed solar energy generation may have a material adverse effect on demand for our offerings.
- The market for our products is developing and may not develop as expected.
- The solar industry has historically been cyclical and experienced periodic downturns.
- Our integrated technological solution may not achieve broader market acceptance, which would prevent us from increasing our revenue and market share.
- Mergers in the solar industry among our current or potential customers may adversely affect our competitive position.
- Our recent and planned expansion into existing and new geographic markets or new product lines or services could subject us to additional business, financial, and competitive risks.
- Lithium-Ion used in our battery cells and packs can potentially catch fire or vent smoke and cause damage or injury.
- If we fail to retain our key personnel or if we fail to attract additional qualified personnel, we may not be able to achieve our anticipated level of growth and our business could suffer.
- Any failure by management to properly manage growth could have a material adverse effect on our business, operating results, and financial condition.

Risks Related to Legal, Compliance and Regulations

- The reduction, elimination or expiration of government subsidies and economic incentives for on-grid solar electricity applications could reduce demand for solar photo-voltaic ("PV") systems and harm our business.
- Changes in current laws or regulations or the imposition of new laws or regulations, or interpretations thereof, in the solar energy sector or international trade, by federal or state agencies in the United States or foreign jurisdictions could impair our ability to compete, and could materially harm our business, financial condition and results of operations.
- Our management has limited experience in operating a public company. The requirements of being a public company may strain our resources and divert management's attention, and the increases in legal, accounting and compliance expenses that will result from being a public company may be greater than we anticipate.
- As a private company, we have not been required to document and test our internal controls over financial reporting nor has our management been required to certify the effectiveness of our internal controls and our auditors have not been required to opine on the effectiveness of our internal control over financial reporting. Failure to maintain adequate financial, information technology and management processes and controls could impair our ability to comply with the financial reporting and internal controls requirements for publicly traded companies, which could lead to errors in our financial reporting and adversely affect our business.
- The installation and operation of our energy storage systems are subject to laws and regulations in various jurisdictions, and there is uncertainty with respect to the interpretation of certain environmental laws and regulations to our energy storage systems, especially as these regulations evolve over time.
- Our significant international operations subject us to additional risks that could adversely affect our business, results of operations and financial condition.
- Our business could be adversely affected by trade tariffs or other trade barriers.
- Current or future litigation or administrative proceedings could have a material adverse effect on our business, financial condition and results of operations.



Risk Factors (cont'd)



Market Opportunity Risks

- The market for our products is highly competitive and we expect to face increased competition as new and existing competitors introduce or develop other smart energy products, which could negatively affect our results of operations and market share. Some of competitors are significantly larger and have greater financial and operational capacities than us.
- A drop in the retail price of electricity derived from the utility grid or from alternative energy sources may harm our business, financial condition, results of operations, and prospects.
- An increase in interest rates or tightening of the supply of capital in the global financial markets could make it difficult for end-users to finance the cost of a solar PV system and could reduce the demand for smart energy products and thus demand for our products.
- Our limited operating history at current scale and our nascent industry make evaluating our business and future prospects difficult.
- If renewable energy technologies are not suitable for widespread adoption or sufficient demand for our hardware and software-enabled services does not develop or takes longer to develop than we anticipate, our sales may decline and we may be unable to achieve or sustain profitability.
- The failure of battery storage cost to continue to decline would have a negative impact on our business and financial condition.
- If the estimates and assumptions we use to determine the size of our total addressable market are inaccurate, our future growth rate may be affected and the potential growth of our business may be limited.

Operating Risks

- Our financial condition and results of operations and other key metrics are likely to be affected by seasonal trends and construction cycles, which could cause our results for a particular period to fall below expectations, resulting in a decline in the price of our common stock.
- Defects or performance problems in our products or delays, disruptions, or quality control problems in our manufacturing operations could result in loss of customers, reputational damage, and decreased revenue, and we may be the subject of numerous claims, including warranty, indemnity, and product liability claims arising from defective products. If any energy storage systems procured from original equipment manufacturers ("OEM") and provided to our customers contain manufacturing defects, our business and financial results could be adversely affected.
- Future product recalls could materially adversely affect our business, financial condition and operating results.
- If our estimates of useful life for our energy storage systems and related hardware and software-enabled services are inaccurate or if our OEM suppliers do not meet service and performance warranties and guarantees, our business and financial results could be adversely affected.
- We expect to incur research and development costs and devote resources to identifying and commercializing new products and services, which may never result in revenue to us.
- Any failure to offer high-quality technical support services may adversely affect our relationships with our customers and adversely affect our financial results.
- The loss of, or events affecting, one or more of our major customers could reduce our sales and have an adverse effect on our business, financial condition and results of operations.
- Our hardware and software-enabled services involve a lengthy sales and installation cycle, and if we fail to close sales on a regular and timely basis it could adversely affect our business, financial condition and results of operations.
- Our business is subject to risks associated with construction, utility interconnection, cost overruns and delays, including those related to obtaining government permits and other contingencies that may arise in the course of completing installations.
- We rely on distributors and installers to assist in selling our products to customers, and the failure of these providers to perform at the expected level, or at all, could have an adverse effect on our business, financial condition and results of our operations.
- The growth of our business depends on customers renewing their monitoring services subscriptions. If customers do not continue to use our subscription service offerings our business and operating results will be adversely affected.
- The threat of global economic, capital markets and credit disruptions pose risks to our business.
- The ongoing COVID-19 pandemic, and global measures taken in response thereto have adversely impacted, and may continue to adversely impact, our operations and financial results.

Third-Party Partner Risks

- We have in some instances, and may in the future, enter into long-term supply agreements that could result in insufficient inventory and negatively affect our results of operations.
- We must maintain customer confidence in our long-term business prospects in order to grow our business.
- We depend on sole-source and limited-source suppliers for key components, raw materials, and products. If we are unable to source these components, raw materials, and products on a timely basis or at acceptable prices, we will not be able to deliver our products to our customers and production time and production costs could increase, which may adversely affect our business.
- We depend upon a small number of outside contract manufacturers, and our business and operations could be disrupted if we encounter problems with these contract manufacturers.



Risk Factors (cont'd)



Risks Related to Intellectual Property and Technology

- Our patent applications may not result in issued patents, and our issued patents may not provide adequate protection, which may have a material adverse effect on our ability to prevent others from commercially exploiting products similar to ours.
- Our failure to protect our intellectual property rights may undermine our competitive position, and litigation to protect our intellectual property rights may be costly.
- We may need to defend ourselves against claims that we infringe, have misappropriated, or otherwise violate the intellectual property rights of others, which may be time-consuming and would cause us to incur substantial costs
- Any unauthorized access to, disclosure, or theft of personal information we gather, store, or use could harm our reputation and subject us to claims or litigation.
- A failure of our information technology and data security infrastructure could adversely affect our business and operations.

Risks Related to Our Financial Condition and Liquidity

- We are under continuous pressure to reduce the prices of our products, which has adversely affected, and may continue to adversely affect, our gross margins.
- If we do not forecast demand for our products accurately, we may experience product shortages, delays in product shipment, excess product inventory, difficulties in planning expenses or disputes with suppliers, any of which will adversely affect our business and financial condition.
- Our focus on a limited number of specific markets increases risks associated with the modification, elimination or expiration of governmental subsidies and economic incentives for on-grid solar electricity applications.

Risks Related to Our Projections

- Our financial projections are based upon estimates and assumptions made at the time they were prepared. If these estimates or assumptions prove to be incorrect or inaccurate, our actual operating results may differ materially from our forecasted results.
- Our financial projections and information regarding prior performance may not prove to be reflective of actual future results.
- Our financial projections assume that revenue from our EI hardware and software will grow significantly. We have not always sold EI hardware and software, so there is a shorter historical basis underpinning the EI hardware and software portions of the forecast, and these products and services may not gain adoption as quickly as we anticipate, if at all.

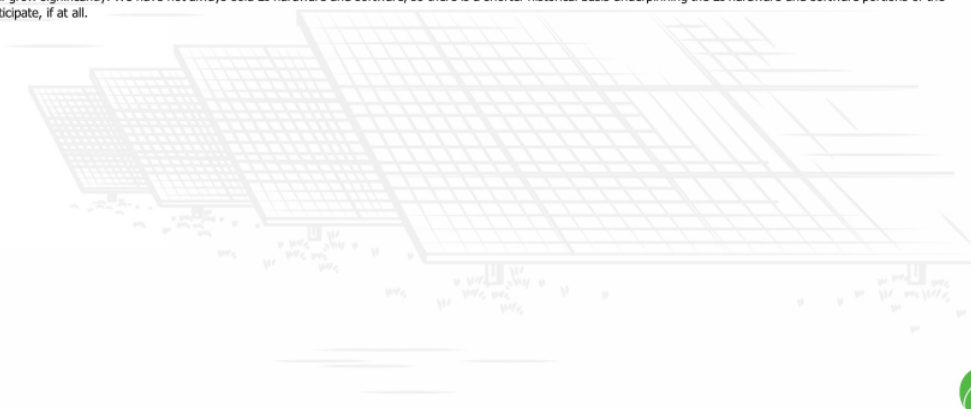

Appendix



AC-Coupled System

Up to 7% round trip energy loss from conversions

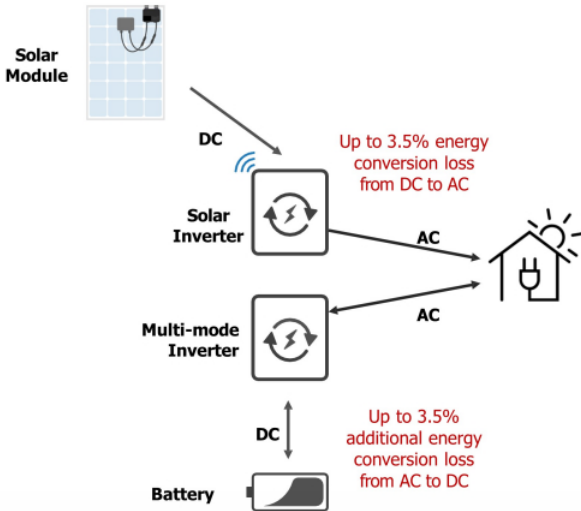

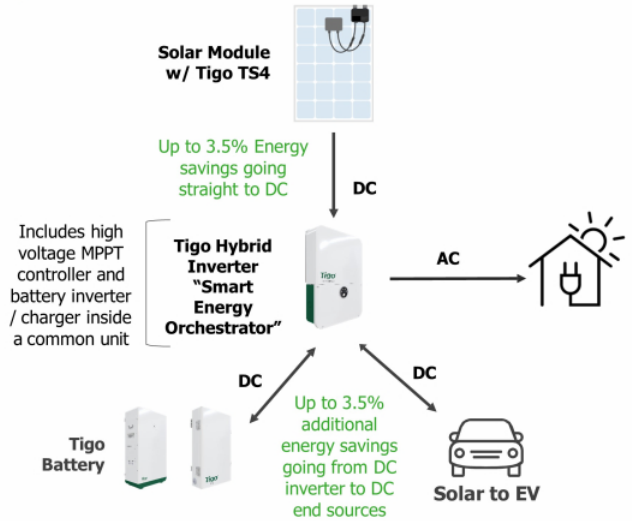

Tigo's DC-Coupled Optimized System

Up to 7% round trip energy savings from conversions



Tigo's DC-Coupled System Delivers Higher Energy Savings at a Lower Cost Compared to AC-Coupled Systems

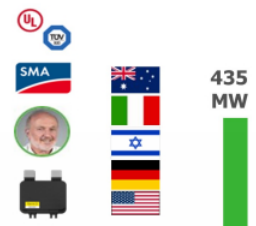

2007 – 2013	2013 – 2019	2019 – 2022	Targets for the Future
<ul style="list-style-type: none"> Initial funding Introduced smart module optimizer technology to the world Release modular designs Develop agile software Penetrate the market  <p>75 MW</p>	<ul style="list-style-type: none"> Zvi Alon joins with an investment Productize TS4-R-x Flex-MLPE Investment from / exclusivity arrangement with SMA Build out AI, Big Data & IOT Certify worldwide  <p>435 MW</p>	<ul style="list-style-type: none"> Independence from SMA Professional management team Productize TS4-A-x globally Partner with multiple OEMs Acceptance of rapid shutdown Adoption of monitoring Global market expansion Launched EI  <p>724 MW</p>	<ul style="list-style-type: none"> Improve balance sheet flexibility Expand into energy management Expand supply chain capacity Accelerate growth organically Accelerate growth through acquisitions Fast delivery with sufficient working capital Grid Services 

Note: MW represents volume of MW installed with Tigo products during the period.

EBITDA Reconciliation

Calendar Year	2020A	2021A	2022E
Net Income	(\$6.2)	(\$4.9)	(\$2.6)
+ Interest Expense	5.5	2.5	3.6
+ Provision for income taxes	0.0	0.2	0.0
+ Depreciation & Amortization	0.6	0.4	0.5
+/- Change in Fair Value of Preferred Stock Warrant Liability	(0.2)	0.2	0.0
+/- Change in Fair Value of Derivative Liability	0.5	0.1	0.0
- Gain on Debt Extinguishment	(0.6)	(1.8)	0.0
+/- Other expense (income), net	0.2	0.0	0.0
EBITDA	(\$0.1)	(\$3.3)	\$1.5
Stock-Based Compensation	0.1	0.2	0.6
M&A Transaction Expenses	-	-	2.0
Adj. EBITDA⁽¹⁾	\$0.0	\$(3.1)	\$4.1
- CapEx	(0.3)	(0.3)	(0.8)
Adj. EBITDA Less CapEx	(\$0.3)	(\$3.4)	\$3.3

1) 2022E Adj. EBITDA excludes stock-based compensation, M&A transaction costs and public company costs.